



PROPOSAL SUBMITTED BY EarthWerks Land Improvement and Development Corp.		
Contractor's Name 1240 Lyon Rd		
Street Batavia	IL	P.O. Box 60510
City	State	Zip Code

STATE OF ILLINOIS

COUNTY DuPage
Village of Villa Park
(Name of City, Village, Town or Road District)

FOR THE IMPROVEMENT OF
STREET NAME OR ROUTE Jackson Pond Overflow
SECTION NO. N/A
TYPES OF FUNDS Local, CDBG-DR

SPECIFICATIONS (required)

PLANS (required)

CONTRACT BOND (when required)

County DuPage
Local Public Agency Villa Park
Section Number N/A
Route Jackson Pond Overflow

1. THIS AGREEMENT, made and concluded the 10th day of December, 2018,
Month and Year

between the Village of Villa Park
acting by and through its Board of Trustees known as the party of the first part, and
EarthWerks Land Improvement and Development Corp. his/their executors, administrators, successors or assigns,
known as the party of the second part.

2. Witnesseth: That for and in consideration of the payments and agreements mentioned in the Proposal hereto attached, to be made and performed by the party of the first part, and according to the terms expressed in the Bond referring to these presents, the party of the second part agrees with said party of the first part at his/their own proper cost and expense to do all the work, furnish all materials and all labor necessary to complete the work in accordance with the plans and specifications hereinafter described, and in full compliance with all of the terms of this agreement and the requirements of the Engineer under it.

3. And it is also understood and agreed that the LPA Formal Contract Proposal, Special Provisions, Affidavit of Illinois Business Office, Apprenticeship or Training Program Certification, and Contract Bond hereto attached, and the Plans for Section N/A, in Village of Villa Park, approved by the Illinois Department of Transportation on N.A. Date, are essential documents of this contract and are a part hereof.

4. IN WITNESS WHEREOF The said parties have executed these presents on the date above mentioned.

Attest: [Signature]
Village Clerk

The Village of Villa Park
By [Signature]
Party of the First Part

(Seal)



(If a Corporation)
Corporate Name EarthWerks Land Improvement and Development Corp.
By [Signature]
President Party of the Second Part

Attest: [Signature]
Secretary

(If a Co-Partnership)

Partners doing Business under the firm name of

Party of the Second Part

(If an individual)

Party of the Second Part

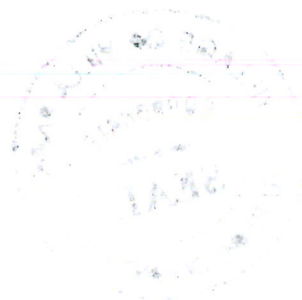

IN TESTIMONY WHEREOF, the said PRINCIPAL and the said SURETY have caused this instrument to be signed by their respective officers this 3rd day of December A.D. 2018

PRINCIPAL

EarthWerks Land Improvement and Development Corp. (Company Name)

(Company Name)

By: DAN DAVIES (Signature & Title) President

By: (Signature & Title)

Attest: DAN DAVIES (Signature & Title) Secretary

Attest: (Signature & Title)

(If PRINCIPAL is a joint venture of two or more contractors, the company names and authorized signature of each contractor must be affixed.)

STATE OF ILLINOIS,

COUNTY OF DuPage

I, DAN DAVIES, a Notary Public in and for said county, do hereby certify that

DAN DAVIES

(Insert names of individuals signing on behalf or PRINCIPAL)

who are each personally known to me to be the same persons whose names are subscribed to the foregoing instrument on behalf of PRINCIPAL, appeared before me this day in person and acknowledged respectively, that they signed and delivered said instrument as their free and voluntary act for the uses and purposes therein set forth.

Given under my hand and notarial seal this 3rd day of December A.D. 2018

My commission expires 3-13-2022

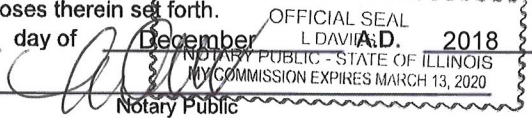

(SEAL)

SURETY

International Fidelity Insurance Company (Name of Surety)

By: Courtney A. Flaska (Signature of Attorney-in-Fact)

Courtney A. Flaska

(SEAL)

STATE OF ILLINOIS.

COUNTY OF DuPage Cook

I, Sherene L. Hemler, a Notary Public in and for said county, do hereby certify that

Courtney A. Flaska

(Insert names of individuals signing on behalf or SURETY)

who are each personally known to me to be the same persons whose names are subscribed to the foregoing instrument on behalf of SURETY, appeared before me this day in person and acknowledged respectively, that they signed and delivered said instrument as their free and voluntary act for the uses and purposes therein set forth.

Given under my hand and notarial seal this 3rd day of December A.D. 2018

My commission expires 03/29/22

Sherene L. Hemler (Signature)

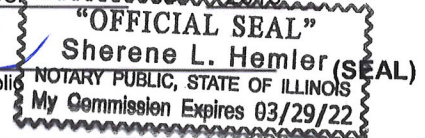

(SEAL)

Approved this 10th day of December, A.D. 2018

Attest: [Signature]

Village

Clerk

Village of Villa Park

(Awarding Authority)

Albert [Signature] (President)

POWER OF ATTORNEY
INTERNATIONAL FIDELITY INSURANCE COMPANY
ALLEGHENY CASUALTY COMPANY

Bond # 0738109

One Newark Center, 20th Floor, Newark, New Jersey 07102-5207 PHONE: (973) 624-7200

KNOW ALL MEN BY THESE PRESENTS: That **INTERNATIONAL FIDELITY INSURANCE COMPANY**, a corporation organized and existing under the laws of the State of New Jersey, and **ALLEGHENY CASUALTY COMPANY** a corporation organized and existing under the laws of the State of New Jersey, having their principal office in the City of Newark, New Jersey, do hereby constitute and appoint

MEREDITH H. MIELKE, MIKE POHL, KIRK A. LISKIEWITZ, COURTNEY A. FLASKA, SAMANTHA BRADTKE, J.S. POHL,
JAMES L. SULKOWSKI, ROBERT B. SCHUTZ, SHERENE L. HEMLER, CAROL A. DOUGHERTY, STEPHEN L. WEBSTER
Schaumburg, IL

their true and lawful attorney(s)-in-fact to execute, seal and deliver for and on its behalf as surety, any and all bonds and undertakings, contracts of indemnity and other writings obligatory in the nature thereof, which are or may be allowed, required or permitted by law, statute, rule, regulation, contract or otherwise, and the execution of such instrument(s) in pursuance of these presents, shall be as binding upon the said **INTERNATIONAL FIDELITY INSURANCE COMPANY** and **ALLEGHENY CASUALTY COMPANY**, as fully and amply, to all intents and purposes, as if the same had been duly executed and acknowledged by their regularly elected officers at their principal offices.

This Power of Attorney is executed, and may be revoked, pursuant to and by authority of the By-Laws of **INTERNATIONAL FIDELITY INSURANCE COMPANY** and **ALLEGHENY CASUALTY COMPANY** and is granted under and by authority of the following resolution adopted by the Board of Directors of **INTERNATIONAL FIDELITY INSURANCE COMPANY** at a meeting duly held on the 20th day of July, 2010 and by the Board of Directors of **ALLEGHENY CASUALTY COMPANY** at a meeting duly held on the 10th day of July, 2015

"RESOLVED, that (1) the Chief Executive Officer, President, Executive Vice President, Vice President, or Secretary of the Corporation shall have the power to appoint, and to revoke the appointments of, Attorneys-in-Fact or agents with power and authority as defined or limited in their respective powers of attorney, and to execute on behalf of the Corporation and affix the Corporation's seal thereto, bonds, undertakings, recognizances, contracts of indemnity and other written obligations in the nature thereof or related thereto; and (2) any such Officers of the Corporation may appoint and revoke the appointments of joint-control custodians, agents for acceptance of process, and Attorneys-in-fact with authority to execute waivers and consents on behalf of the Corporation; and (3) the signature of any such Officer of the Corporation and the Corporation's seal may be affixed by facsimile to any power of attorney or certification given for the execution of any bond, undertaking, recognizance, contract of indemnity or other written obligation in the nature thereof or related thereto, such signature and seals when so used whether heretofore or hereafter, being hereby adopted by the Corporation as the original signature of such officer and the original seal of the Corporation, to be valid and binding upon the Corporation with the same force and effect as though manually affixed."

IN WITNESS WHEREOF, **INTERNATIONAL FIDELITY INSURANCE COMPANY** and
ALLEGHENY CASUALTY COMPANY have each executed and attested these presents
on this 31st day of December, 2017



STATE OF NEW JERSEY
County of Essex

George R. James

Executive Vice President (International Fidelity Insurance Company) and
Vice President (Allegheny Casualty Company)



On this 31st day of December, 2017, before me came the individual who executed the preceding instrument, to me personally known, and, being by me duly sworn, said he is the therein described and authorized officer of **INTERNATIONAL FIDELITY INSURANCE COMPANY** and of **ALLEGHENY CASUALTY COMPANY**; that the seals affixed to said instrument are the Corporate Seals of said Companies; that the said Corporate Seals and his signature were duly affixed by order of the Boards of Directors of said Companies.

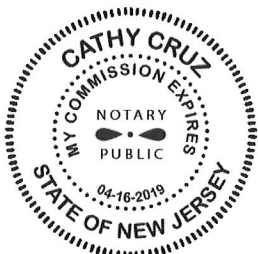

IN TESTIMONY WHEREOF, I have hereunto set my hand affixed my Official Seal, at the City of Newark,
New Jersey the day and year first above written.

Cathy Cruz a Notary Public of New Jersey
My Commission Expires April 16, 2019

CERTIFICATION

I, the undersigned officer of **INTERNATIONAL FIDELITY INSURANCE COMPANY** and **ALLEGHENY CASUALTY COMPANY** do hereby certify that I have compared the foregoing copy of the Power of Attorney and affidavit, and the copy of the Sections of the By-Laws of said Companies as set forth in said Power of Attorney, with the originals on file in the home of said companies, and that the same are correct transcripts thereof, and of the whole of the said originals, and that the said Power of Attorney has not been revoked and is now in full force and effect.

IN TESTIMONY WHEREOF, I have hereunto set my hand on this day, December 03, 2018

A00319

Maria H. Branco, Assistant Secretary



CERTIFICATE OF LIABILITY INSURANCE

DATE (MM/DD/YYYY)
11/30/2018

THIS CERTIFICATE IS ISSUED AS A MATTER OF INFORMATION ONLY AND CONFERS NO RIGHTS UPON THE CERTIFICATE HOLDER. THIS CERTIFICATE DOES NOT AFFIRMATIVELY OR NEGATIVELY AMEND, EXTEND OR ALTER THE COVERAGE AFFORDED BY THE POLICIES BELOW. THIS CERTIFICATE OF INSURANCE DOES NOT CONSTITUTE A CONTRACT BETWEEN THE ISSUING INSURER(S), AUTHORIZED REPRESENTATIVE OR PRODUCER, AND THE CERTIFICATE HOLDER.

IMPORTANT: If the certificate holder is an ADDITIONAL INSURED, the policy(ies) must be endorsed. If SUBROGATION IS WAIVED, subject to the terms and conditions of the policy, certain policies may require an endorsement. A statement on this certificate does not confer rights to the certificate holder in lieu of such endorsement(s).

PRODUCER DSP Insurance Services 1900 E Golf Rd, Suite 650 Schaumburg IL 61073	CONTACT NAME: PHONE (A/C, No, Ext): (847) 934-6100	FAX (A/C, No): (847) 934-6186													
	E-MAIL ADDRESS: <table border="1"> <tr> <th>INSURER(S) AFFORDING COVERAGE</th> <th>NAIC #</th> </tr> <tr> <td>INSURER A: ACUITY A Mutual Insurance Co.</td> <td>14184</td> </tr> <tr> <td>INSURER B:</td> <td></td> </tr> <tr> <td>INSURER C:</td> <td></td> </tr> <tr> <td>INSURER D:</td> <td></td> </tr> <tr> <td>INSURER E:</td> <td></td> </tr> <tr> <td>INSURER F:</td> <td></td> </tr> </table>		INSURER(S) AFFORDING COVERAGE	NAIC #	INSURER A: ACUITY A Mutual Insurance Co.	14184	INSURER B:		INSURER C:		INSURER D:		INSURER E:		INSURER F:
INSURER(S) AFFORDING COVERAGE	NAIC #														
INSURER A: ACUITY A Mutual Insurance Co.	14184														
INSURER B:															
INSURER C:															
INSURER D:															
INSURER E:															
INSURER F:															
INSURED Earthwerks Land Improvement & Development Corp 1240 Lyon Rd Batavia IL 60510	(630) 482-2341														

COVERAGES

CERTIFICATE NUMBER: Cert ID 22971

REVISION NUMBER:

THIS IS TO CERTIFY THAT THE POLICIES OF INSURANCE LISTED BELOW HAVE BEEN ISSUED TO THE INSURED NAMED ABOVE FOR THE POLICY PERIOD INDICATED. NOTWITHSTANDING ANY REQUIREMENT, TERM OR CONDITION OF ANY CONTRACT OR OTHER DOCUMENT WITH RESPECT TO WHICH THIS CERTIFICATE MAY BE ISSUED OR MAY PERTAIN, THE INSURANCE AFFORDED BY THE POLICIES DESCRIBED HEREIN IS SUBJECT TO ALL THE TERMS, EXCLUSIONS AND CONDITIONS OF SUCH POLICIES. LIMITS SHOWN MAY HAVE BEEN REDUCED BY PAID CLAIMS.

INSR LTR	TYPE OF INSURANCE	ADDL INSD	SUBR WVD	POLICY NUMBER	POLICY EFF (MM/DD/YYYY)	POLICY EXP (MM/DD/YYYY)	LIMITS
A	<input checked="" type="checkbox"/> COMMERCIAL GENERAL LIABILITY <input type="checkbox"/> CLAIMS-MADE <input checked="" type="checkbox"/> OCCUR GEN'L AGGREGATE LIMIT APPLIES PER: <input type="checkbox"/> POLICY <input checked="" type="checkbox"/> PROJECT <input type="checkbox"/> LOC OTHER:			K61056	03/20/2018	03/20/2019	EACH OCCURRENCE \$ 1,000,000 DAMAGE TO RENTED PREMISES (Ea occurrence) \$ 500,000 MED EXP (Any one person) \$ 10,000 PERSONAL & ADV INJURY \$ 1,000,000 GENERAL AGGREGATE \$ 3,000,000 PRODUCTS - COMP/OP AGG \$ 3,000,000
A	AUTOMOBILE LIABILITY <input checked="" type="checkbox"/> ANY AUTO <input type="checkbox"/> ALL OWNED AUTOS <input type="checkbox"/> SCHEDULED AUTOS <input checked="" type="checkbox"/> HIRED AUTOS <input checked="" type="checkbox"/> NON-OWNED AUTOS			K61056	03/20/2018	03/20/2019	COMBINED SINGLE LIMIT (Ea accident) \$ 1,000,000 BODILY INJURY (Per person) \$ BODILY INJURY (Per accident) \$ PROPERTY DAMAGE (Per accident) \$
A	<input type="checkbox"/> UMBRELLA LIAB <input checked="" type="checkbox"/> OCCUR <input checked="" type="checkbox"/> EXCESS LIAB <input type="checkbox"/> CLAIMS-MADE DED RETENTION \$			K61056	03/20/2018	03/20/2019	EACH OCCURRENCE \$ 5,000,000 AGGREGATE \$ 5,000,000
A	WORKERS COMPENSATION AND EMPLOYERS' LIABILITY ANY PROPRIETOR/PARTNER/EXECUTIVE OFFICER/MEMBER EXCLUDED? (Mandatory in NH) If yes, describe under DESCRIPTION OF OPERATIONS below		N/A	K61056	03/20/2018	03/20/2019	<input checked="" type="checkbox"/> PER STATUTE <input type="checkbox"/> OTH-ER E.L. EACH ACCIDENT \$ 1,000,000 E.L. DISEASE - EA EMPLOYEE \$ 1,000,000 E.L. DISEASE - POLICY LIMIT \$ 1,000,000
A	Property			K61056	03/20/2018	03/20/2019	See below if applicable
A	Equipment			K61056	03/20/2018	03/20/2019	Leased/Rented \$ 500,000

DESCRIPTION OF OPERATIONS / LOCATIONS / VEHICLES (ACORD 101, Additional Remarks Schedule, may be attached if more space is required)
Re: Jackson Pond Overflow Project

Additional insured on General Liability and Auto Liability when required by written contract:
Village of Villa Park, Its officials, employees, agents and volunteers; School District 45
Waiver of subrogation applies in favor of the additional insured on Workers Compensation when required by written contract.

CERTIFICATE HOLDER

Village of Villa Park
20 South Ardmore Avenue,
Villa Park IL 60181-2696

CANCELLATION

SHOULD ANY OF THE ABOVE DESCRIBED POLICIES BE CANCELLED BEFORE THE EXPIRATION DATE THEREOF, NOTICE WILL BE DELIVERED IN ACCORDANCE WITH THE POLICY PROVISIONS.

AUTHORIZED REPRESENTATIVE

© 1988-2014 ACORD CORPORATION. All rights reserved.

ADDITIONAL INSURED - OWNERS, LESSEES OR CONTRACTORS - PRIMARY AND NONCONTRIBUTORY

CG-7351(12-11)

This endorsement modifies insurance provided under the following:

COMMERCIAL GENERAL LIABILITY COVERAGE PART

1. Section II - Who Is an Insured is amended to include as an insured the person or organization shown in the Schedule, but only with respect to liability arising out of your ongoing operations performed for that insured.
2. Coverage, as provided by this endorsement, will be primary and noncontributory with respect to other coverages available to the additional insured(s).
3. Coverage under this endorsement does not apply

to *bodily injury* or *property damage* occurring after:

- a. All work, including materials, parts or equipment furnished in connection with such work, on the project (other than service, maintenance or repairs) to be performed by or on behalf of the additional insured(s) at the site of the covered operations has been completed; or
- b. That portion of *your work* out of which the injury or damage arises has been put to its intended use by any person or organization other than another contractor or subcontractor engaged in performing operations for a principal as a part of the same project.

SCHEDULE

**Person or Organization
(Name and Address)**

**ADDITIONAL INSURED - OWNERS, LESSEES OR CONTRACTORS -
COMPLETED OPERATIONS - PRIMARY AND NONCONTRIBUTORY**

CG-7352(12-11)

This endorsement modifies insurance provided under the following:

COMMERCIAL GENERAL LIABILITY COVERAGE PART

Section II - Who Is an Insured is amended to include as an insured the person or organization shown in the Schedule, but only with respect to liability arising out of *your work* at the location designated and

described in the Schedule of this endorsement performed for that insured and included in the *products-completed operations hazard*.

The coverage provided by this endorsement will be primary and noncontributory with respect to any other coverage available to the additional insured.

SCHEDULE

**Person or Organization
(Name and Address)**

Location and Description of Completed Operations



VILLAGE OF VILLA PARK

CONTRACT DOCUMENTS

FOR

JACKSON POND OVERFLOW PROJECT

ISSUED FOR BID OCTOBER 13, 2018

PREPARED BY



**7325 JANES AVENUE
WOODRIDGE, ILLINOIS 60517**

NOTICE: FEDERAL LABOR STANDARDS, PREVAILING WAGE RATES, AND SECTION 3 REGULATIONS WILL APPLY TO THIS PROJECT.

MINORITIES AND WOMEN OWNED BUSINESSES (MBE/WBE) ARE ENCOURAGED TO SUBMIT BIDS ON THIS PROJECT.

OWNER COPY

CONTRACT

**ADVERTISEMENT FOR BIDS
VILLAGE OF VILLA PARK
SATURDAY, OCTOBER 13, 2018**

PROJECT: JACKSON POND OVERFLOW PROJECT

The Jackson Pond Overflow Project consists of the construction of an overflow detention basin and an overflow channel to that basin on the Village owned property downstream of Jackson Pond, as well as minor expansion of the existing Jackson Pond detention basin itself. The project includes earthwork associated with the overflow basin construction and the existing detention basin expansion; the construction of new storm sewer that discharges to Sugar Creek, along with associated flared end sections, grates, culverts, underdrains, manholes, catch basins, inlets, and headwalls; the replacement of the existing baseball field in order to accommodate the detention basin improvements, along with associated baseball field elements including fences, gates, bleachers, player benches, netting, and irrigation; replacement of the existing pedestrian sidewalk located in the proposed overflow detention basin with a pedestrian bridge; removal of existing lighting in conflict with construction operations and replacement as necessary; relocation of existing water main located in the proposed overflow detention basin; restoration of existing asphalt and concrete pavements and sidewalks disturbed by construction; fine grading of the entire disturbed area; placement of topsoil; placement of sodding or seed and blanket; construction layout; traffic control and protection; and other necessary related and incidental work.

Minorities and Women Owned Businesses (MBE/WBE) are encouraged to submit bids on this Project.

Federal Labor Standards, Davis-Bacon Prevailing Wage rates, and Section 3 regulations will apply to this project.

BID DEADLINE: Tuesday, October 30, 2018, 10:00 A.M. LOCAL TIME

The Village reserves the right to extend the Bid Deadline from this date and time to accept Bids submitted after the Bid Deadline, as the Village, in its sole discretion, determines is in the best interest of the Village.

MANDATORY PRE-BID MEETING: Tuesday, October 23, 2018, 10:00 A.M. LOCAL TIME

A mandatory pre-bid meeting will be held at the Public Works Department, 11 West Home Avenue, Villa Park, Illinois, 60181.

NOTICE: Separate, sealed proposals for the **JACKSON POND OVERFLOW PROJECT** will be received by the Village of Villa Park, Illinois, at the reception desk of the Public Works Department, 11 West Home Avenue, Villa Park, Illinois, 60181, until the Bid Deadline. Immediately thereafter, the proposals will be publicly opened and read aloud at the offices of the Public Works Department. Notwithstanding the foregoing, the Village reserves the right to defer, postpone, delay, or reschedule the Bid Opening for such time and to such date as the Village, in its sole discretion, determines is in the best interest of the Village.

Proposals shall be submitted in accordance with the Bidding Documents prepared by V3 Companies, 7325 Janes Avenue, Woodridge, IL 60517.

BIDDER QUALIFICATIONS: Bidders, in submitting a Bid, shall comply with all applicable Federal, State and Local laws and requirements; shall provide documentation of that compliance in accordance with the requirements of the Contract Documents or as requested by the Village; and, in submitting a Bid, Bidders affirm that they are qualified under all applicable laws and requirements to do so, and agree to be bound by the determination of the Village as to Bidder's compliance and qualifications.

BID SECURITY: Bid security in the amount of not less than five percent (5%) of the Bid shall accompany each Bid in accordance with the Bidding Documents.

CONTRACT SECURITY: The Bidder to whom a Contract is awarded shall be required to furnish both a Performance Bond and a Labor and Mechanical Payment Bond acceptable to the Village for one-hundred percent (100%) of the Contract Price, in accordance with the requirements of the Contract Documents.

RIGHTS RESERVED: The Village will select the lowest, most responsible bidder. The Village reserves the right to reject any and all Bids, to waive any informalities or technicalities in bidding, and to accept the Bid which best serves the interests of the Village. The Village shall, in its sole discretion, determine what does or does not constitute an informality or technicality, and, in submitting a Bid, Bidder agrees to be bound by that determination.

The Village may make such investigations as it deems necessary to determine the ability of the Bidder to perform the Work, and the Bidder shall furnish to the Village all such information and data for this purpose as the Village may request. The Village reserves the right to reject any Bid if the evidence submitted by, or investigation of, such Bidder fails to satisfy the Village that such Bidder is properly qualified to carry out the obligations of the Agreement and to complete the Work contemplated therein.

WAGE RATES: All applicable laws, ordinances, and the rules and regulations of all authorities having jurisdiction over construction of the PROJECT shall apply to the contract throughout.

CONTRACT DOCUMENTS: The Bidding Documents are on file for inspection at the office of the Village of Villa Park Public Works Department, 11 West Home Avenue, Villa Park, Illinois, 60181, and may also be obtained from the Village of Villa Park Public Works Department at the address listed above for a non-refundable fee of twenty dollars (\$20.00).

PUBLISHED BY AUTHORITY OF THE VILLAGE OF VILLA PARK, DUPAGE COUNTY, ILLINOIS.

BY:



Vydas Juskelevs, P.E.
Director of Public Works

1

RETURN WITH BID



Local Public Agency
Formal Contract Proposal

PROPOSAL SUBMITTED BY		
Earth Works Land Improvement &		
Contractor's Name Development Corporation		
1240 LYON RD		
Street		P.O. Box
BATAVIA	IL	60510
City	State	Zip Code

STATE OF ILLINOIS

COUNTY OF DuPage
Village of Villa Park
 (Name of City, Village, Town or Road District)

FOR THE IMPROVEMENT OF
 STREET NAME OR ROUTE NO. Jackson Pond Overflow
 SECTION NO. N/A
 TYPES OF FUNDS Local, CDBG-DR

SPECIFICATIONS (required)

PLANS (required)

Note: All proposal documents, including Proposal Guaranty Checks or Proposal Bid Bonds, should be stapled together to prevent loss when bids are processed.

OWNER COPY

CONTRACT

RETURN WITH BID

NOTICE TO BIDDERS

County DuPage
Local Public Agency Villa Park
Section Number N/A
Route Jackson Pond Overflow Project

Sealed proposals for the improvement described below will be received at the office of Public Works Department,
11 West Home Ave, Villa Park, IL 60181 until 10:00 AM on
Address Time Date

Sealed proposals will be opened and read publicly at the office of Public Works Department
11 West Home Ave, Villa Park, IL 60181 at 10:00 AM on
Address Time Date

DESCRIPTION OF WORK

Name 2018 Jackson Pond Overflow Project Length: 1800.00 feet (0.34 miles)
Location W. Highridge Rd from Highridge to Ardmore Ave and field area to north;
Proposed Improvement

The Jackson Pond Overflow Project consists of the construction of an overflow detention basin and an overflow channel to that basin on the Village owned property downstream of Jackson Pond, as well as minor expansion of the existing Jackson Pond detention basin itself. The project includes earthwork associated with the overflow basin construction and the existing detention basin expansion; the construction of new storm sewer that discharges to Sugar Creek, along with associated flared end sections, grates, culverts, underdrains, manholes, catch basins, inlets, and headwalls; the replacement of the existing baseball field in order to accommodate the detention basin improvements, along with associated baseball field elements including fences, gates, bleachers, player benches, netting, and irrigation; replacement of the existing pedestrian sidewalk located in the proposed overflow detention basin with a pedestrian bridge; removal of existing lighting in conflict with construction operations and replacement as necessary; relocation of existing water main located in the proposed overflow detention basin; restoration of existing asphalt and concrete pavements and sidewalks disturbed by construction; fine grading of the entire disturbed area; placement of topsoil; placement of sodding or seed and blanket; construction layout; traffic control and protection; and other necessary related and incidental work.

1. Plans and proposal forms will be available in the office of Village of Villa Park Public Works Department
11 West Home Ave, Villa Park, IL 60181 630-834-8505
Address

2. [] Prequalification
If checked, the 2 low bidders must file within 24 hours after the letting an "Affidavit of Availability" (Form BC 57), in duplicate, showing all uncompleted contracts awarded to them and all low bids pending award for Federal, State, County, Municipal and private work. One original shall be filed with the Awarding Authority and one original with the IDOT District Office.

3. The Awarding Authority reserves the right to waive technicalities and to reject any or all proposals as provided in BLRS Special Provision for Bidding Requirements and Conditions for Contract Proposals.

- 4. The following BLR Forms shall be returned by the bidder to the Awarding Authority:
a. BLR 12200: Local Public Agency Formal Contract Proposal
b. BLR 12200a Schedule of Prices
c. BLR 12230: Proposal Bid Bond (if applicable)
d. BLR 12325: Apprenticeship or Training Program Certification (do not use for federally funded projects)
e. BLR 12326: Affidavit of Illinois Business Office

OWNER COPY

CONTRACT

RETURN WITH BID

5. The quantities appearing in the bid schedule are approximate and are prepared for the comparison of bids. Payment to the Contractor will be made only for the actual quantities of work performed and accepted or materials furnished according to the contract. The scheduled quantities of work to be done and materials to be furnished may be increased, decreased or omitted as hereinafter provided.
6. Submission of a bid shall be conclusive assurance and warranty the bidder has examined the plans and understands all requirements for the performance of work. The bidder will be responsible for all errors in the proposal resulting from failure or neglect to conduct an in depth examination. The Awarding Authority will, in no case be responsible for any costs, expenses, losses or changes in anticipated profits resulting from such failure or neglect of the bidder.
7. The bidder shall take no advantage of any error or omission in the proposal and advertised contract.
8. If a special envelope is supplied by the Awarding Authority, each proposal should be submitted in that envelope furnished by the Awarding Agency and the blank spaces on the envelope shall be filled in correctly to clearly indicate its contents. When an envelope other than the special one furnished by the Awarding Authority is used, it shall be marked to clearly indicate its contents. When sent by mail, the sealed proposal shall be addressed to the Awarding Authority at the address and in care of the official in whose office the bids are to be received. All proposals shall be filed prior to the time and at the place specified in the Notice to Bidders. Proposals received after the time specified will be returned to the bidder unopened.
9. Permission will be given to a bidder to withdraw a proposal if the bidder makes the request in writing or in person before the time for opening proposals.

OWNER COPY

CONTRACT

RETURN WITH BID

PROPOSAL

County DuPage
 Local Public Agency Villa Park
 Section Number N/A
 Route Jackson Pond Overflow Project

1. Proposal of EarthWise Land Improvement & Development Corporation
1240 Lyon Rd, Batavia IL 60510
 for the improvement of the above section by the construction of earth excavation for basin and swale construction;
pavement/driveway/C&G/sidewalk/ remove and replace; storm sewer removal/reinstallation;
ball field construction; HMA paving; restore

a total distance of 1800.00 feet, of which a distance of 1800.00 feet, (0.341 miles) are to be improved.

- 2. The plans for the proposed work are those prepared by V3 Companies and approved by the Department of Transportation on N.A.
- 3. The specifications referred to herein are those prepared by the Department of Transportation and designated as "Standard Specifications for Road and Bridge Construction" and the "Supplemental Specifications and Recurring Special Provisions" thereto, adopted and in effect on the date of invitation for bids.
- 4. The undersigned agrees to accept, as part of the contract, the applicable Special Provisions indicated on the "Check Sheet for Recurring Special Provisions" contained in this proposal.
- 5. The undersigned agrees to complete the work within N/A working days or by N/A unless additional time is granted in accordance with the specifications.
- 6. A proposal guaranty in the proper amount, as specified in BLRS Special Provision for Bidding Requirements and Conditions for Contract Proposals, will be required. Bid Bonds will be allowed as a proposal guaranty. Accompanying this proposal is either a bid bond if allowed, on Department form BLR 12230 or a proposal guaranty check, complying with the specifications, made payable to:

Village Treasurer of Villa Park

The amount of the check is 5% of Bid ().

- 7. In the event that one proposal guaranty check is intended to cover two or more proposals, the amount must be equal to the sum of the proposal guaranties, which would be required for each individual proposal. If the proposal guaranty check is placed in another proposal, it will be found in the proposal for: Section Number N.A.
- 8. The successful bidder at the time of execution of the contract will be required to deposit a contract bond for the full amount of the award. When a contract bond is not required, the proposal guaranty check will be held in lieu thereof. If this proposal is accepted and the undersigned fails to execute a contract and contract bond as required, it is hereby agreed that the Bid Bond or check shall be forfeited to the Awarding Authority.
- 9. Each pay item should have a unit price and a total price. If no total price is shown or if there is a discrepancy between the product of the unit price multiplied by the quantity, the unit price shall govern. If a unit price is omitted, the total price will be divided by the quantity in order to establish a unit price.
- 10. A bid will be declared unacceptable if neither a unit price nor a total price is shown.
- 11. The undersigned submits herewith the schedule of prices on BLR 12200a covering the work to be performed under this contract.
- 12. The undersigned further agrees that if awarded the contract for the sections contained in the combinations on BLR 12200a, the work shall be in accordance with the requirements of each individual proposal for the multiple bid specified in the Schedule for Multiple Bids below.

OWNER COPY

CONTRACT

RETURN WITH BID



SCHEDULE OF PRICES

County DuPage
 Local Public Agency Villa Park
 Section N/A

Route
Jackson Pond Overflow

Schedule for Multiple Bids

Combination Letter	Sections Included in Combinations	Total

Schedule for Single Bid

(For complete information covering these items, see plans and specifications)

Bidder's Proposal for making Entire Improvements

Item No.	Items	Unit	Quantity	Unit Price	Total
1	TREE REMOVAL (6 TO 15 UNITS DIAMETER)	UNIT	196	10.	1960.
2	TREE REMOVAL (OVER 15 UNITS DIAMETER)	UNIT	918	13.	11934.
3	TEMPORARY FENCE	FOOT	546	2.	1092.
4	EARTH EXCAVATION	CU YD	36,580	10.	365800.
5	REMOVAL AND DISPOSAL OF UNSUITABLE MATERIALS	CU YD	3,212	28.	89936.
6	POROUS GRANULAR EMBANKMENT	CU YD	45	45.	2025.
7	TRENCH BACKFILL	CU YD	511	37.	18907.
8	TOPSOIL EXCAVATION AND PLACEMENT	CU YD	5,130	6.	30780.
9	TOPSOIL FURNISH AND PLACE, 12"	SQ YD	24,660	8.	197280.
10	SEEDING, CLASS 1	AC	7	4000.	28000.
11	EROSION CONTROL BLANKET	SQ YD	15,904	1.50	23856.
12	PERIMETER EROSION BARRIER	FOOT	2,284	1.75	3997.
13	INLET FILTERS	EACH	11	160.	1760.
14	STONE RIPRAP, CLASS A4	SQ YD	71	68.	4828.
15	FILTER FABRIC	SQ YD	71	2.	142.
16	AGGREGATE BASE COURSE, TYPE B 4"	SQ YD	25	4.	100.
17	AGGREGATE BASE COURSE, TYPE B 6"	SQ YD	1,507	6.	9042.

OWNER COPY

CONTRACT

RETURN WITH BID

Bidder's Proposal for making Entire Improvements

Item No.	Items	Unit	Quantity	Unit Price	Total
18	PORTLAND CEMENT CONCRETE BASE COURSE 7"	SQ YD	100	68.	6800.
19	PORTLAND CEMENT CONCRETE BASE COURSE 12"	SQ YD	105	95.	9975.
20	BITUMINOUS MATERIALS (TACK COAT)	POUNDS	582	2.	1164.
21	HOT-MIX ASPHALT SURFACE COURSE, MIX "D", N50	TON	48	270.	12960.
22	PORTLAND CEMENT CONCRETE PAVEMENT, 8"	SQ YD	25	70.	1750.
23	PORTLAND CEMENT CONCRETE SIDEWALK 5"	SQ FT	4,137	7.	28959.
24	DETECTABLE WARNINGS	SQ FT	21	38.	798.
25	SIDEWALK REMOVAL	SQ FT	3,930	2.	7860.
26	AGGREGATE SHOULDERS, TYPE A 6"	SQ YD	287	7.	2009.
27	CONCRETE HEADWALL REMOVAL	EACH	2	1000.	2000.
28	PIPE CULVERT REMOVAL	FOOT	32	10.	320.
29	STRUCTURE EXCAVATION	CU YD	127	27.	3429.
30	CONCRETE STRUCTURES	CU YD	26	1700.	44200.
31	REINFORCEMENT BARS, EPOXY COATED	POUND	3,880	1.70	6596.
32	PRECAST REINFORCED CONCRETE FLARED END SECTION 12"	EACH	1	1050.	1050.
33	PRECAST REINFORCED CONCRETE FLARED END SECTION 30"	EACH	1	1800.	1800.
34	WATER MAIN 6"	FOOT	20	90.	1800.
35	ADJUSTING WATER MAIN 6"	FOOT	58	450.	26100.
36	DUCTILE IRON WATER MAIN FITTINGS 6" 45.00 DEGREE BEND	EACH	4	250.	1000.
37	CONCRETE HEADWALLS FOR PIPE DRAINS	EACH	1	500.	500.
38	PIPE UNDERDRAINS, TYPE 1, 6"	FOOT	566	21.	11886.
39	CATCH BASINS, TYPE A, 5'-DIAMETER, TYPE 1 FRAME, OPEN LID	EACH	1	4800.	4800.
40	CATCH BASINS, TYPE A, 5'-DIAMETER, TYPE 11V FRAME AND GRATE	EACH	1	4800.	4800.
41	CATCH BASINS, TYPE C, TYPE 11V FRAME AND GRATE	EACH	1	1550.	1550.
42	MANHOLES, TYPE A, 5' DIAMETER, TYPE 1 FRAME, CLOSED LID	EACH	7	3700.	25900.
43	INLETS, TYPE A, TYPE 8 GRATE	EACH	5	1200.	6000.
44	COMBINATION CONCRETE CURB AND GUTTER, TYPE B-6.12	FOOT	139	40.	5560.

OWNER COPY

CONTRACT

RETURN WITH BID

Bidder's Proposal for making Entire Improvements

Item No.	Items	Unit	Quantity	Unit Price	Total
45	CHAIN LINK FENCE, HEIGHT 4'	FOOT	390	40.	15600.
46	CHAIN LINK FENCE, HEIGHT 6'	FOOT	615	42.	25830.
47	CHAIN LINK FENCE, HEIGHT 8'	FOOT	270	56.	15120.
48	CHAIN LINK GATES, 8' X 4' SINGLE	EACH	2	650.	1300.
49	CHAIN LINK GATES, 4' X 10' DOUBLE	EACH	4	1000.	4000.
50	NON-SPECIAL WASTE DISPOSAL	CU YD	3,212	8.	25696.
51	THERMOPLASTIC PAVEMENT MARKING - LINE 4"	FOOT	20	10.	200.
52	THERMOPLASTIC PAVEMENT MARKING - LINE 6"	FOOT	10	12.	120.
53	THERMOPLASTIC PAVEMENT MARKING - LINE 12"	FOOT	36	18.	648.
54	THERMOPLASTIC PAVEMENT MARKING - LINE 24"	FOOT	15	20.	300.
55	ELECTRIC SERVICE INSTALLATION	EACH	1	5000.	5000.
56	UNIT DUCT, 600V, 2-1C NO.8, 1/C NO.8 GROUND, (XLP-TYPE USE), 3/4" DIA.	FOOT	245	11.	2695.
57	UNIT DUCT, 600V, 2-1C NO.10, 1/C NO.10 GROUND, (XLP-TYPE USE), 3/4" DIA. POLYETHYLENE	FOOT	40	10.	400.
58	UNIT DUCT, 600V, 2-1C NO.6, 1/C NO.6 GROUND, (XLP-TYPE USE), 1" DIA. POLYETHYLENE	FOOT	40	12.	480.
59	LIGHT POLE FOUNDATION, 24" DIAMETER	FOOT	12	1500.	18000.
60	REMOVAL OF PEDESTRIAN LIGHT FIXTURE, SALVAGE	EACH	2	600.	1200.
61	REMOVAL OF LIGHTING UNIT, SALVAGE	EACH	3	500.	1500.
62	REMOVAL OF POLE FOUNDATION	EACH	3	1000.	3000.
63	REMOVE ELECTRIC CABLE FROM CONDUIT	FOOT	2,400	1. ³⁰	3120.
64	STORM SEWER, CLASS A, TYPE 2 12"	FOOT	59	65.	3835.
65	STORM SEWERS, CLASS A, TYPE 2 18"	FOOT	25	53.	1325.
66	STORM SEWER, CLASS A, TYPE 2 30"	FOOT	848	175.	148400.
67	STORM SEWERS, CLASS B, TYPE 1 12"	FOOT	86	75.	6450.
68	IRRIGATION SYSTEM SPECIAL	L SUM	1	47000.	47000.
69	BENCH REMOVAL	EACH	3	200.	600.
70	PLAYERS BENCH	EACH	2	800.	1600.
71	PEDESTRIAN TRUSS SUPERSTRUCTURE	SQ FT	141	190.	26790.

OWNER COPY

CONTRACT

Bidder's Proposal for making Entire Improvements

Item No.	Items	Unit	Quantity	Unit Price	Total
72	DRAINAGE RESTRICTOR	EACH	1	350.	350.
73	REMOVE AND REPLACE SIGN AND SUPPORTS	EACH	1	2000.	2000.
74	DRAINAGE WEIR	EACH	1	3800.	3800.
75	EXPLORATION TRENCH, SPECIAL	FOOT	20	100.	2000.
76	STORM SEWERS, DUCTILE IRON PIPE 30"	FOOT	38	275.	10450.
77	TRAFFIC CONTROL AND PROTECTION (SPECIAL)	L SUM	1	10000.	10000.
78	PRECONSTRUCTION VIDEO RECORDING	L SUM	1	3000.	3000.
79	CONCRETE REMOVAL (SPECIAL)	SQ YD	104	15.	1560.
80	STABILIZED CONSTRUCTION ENTRANCE	SQ YD	45	12.	540.
81	CONSTRUCTION LAYOUT	L SUM	1	10000.	10000.
82	FENCE REMOVAL	FOOT	699	5.	3495.
83	4' BY 4' BOX STRUCTURE	EACH	1	8000.	8000.
84	BASEBALL INFIELD MIX	SQ YD	1,319	15.	19785.
85	BASES	LSUM	1	1000.	1000.
86	BLEACHERS	EACH	1	2500.	2500.
87	BOX PACKING CLAY	SQ YD	11	50.	550.
88	COMED PRIMARY SPLICE BOX (INSTALL ONLY)	EACH	0		0.
89	CULVERT INLET PROTECTION	EACH	1	100.	100.
90	DUGOUT REMOVAL	EACH	2	1000.	2000.
91	ELECTRICAL CABINET, COMPLETE	EACH	1	47000.	47000.
92	GRASS PAVERS	SQ FT	420	12.	5040.
93	GRATING FOR CONCRETE FLARED END SECTION 12"	EACH	1	600.	600.
94	GRATING FOR CONCRETE FLARED END SECTION 30"	EACH	1	600.	600.
95	LIMESTONE SCREENINGS	SQ YD	1,292	4.	5168.
96	NETTING	L SUM	1	90000.	90000.

OWNER COPY

CONTRACT

Bidder's Proposal for making Entire Improvements

Item No.	Items	Unit	Quantity	Unit Price	Total
97	PEDESTRIAN LIGHT UNIT, COMPLETE	EACH	2	7000.	14000.
98	PEDESTRIAN LIGHT UNIT, FIXTURE ONLY	EACH	2	3000.	6000.
99	PLASTIC FLARED END SECTION	EACH	4	200.	800.
100	PLAYING FIELD SEEDING	SQ YD	9,893	2.	19786.
101	PLAYING FIELD SODDING	SQ YD	887	8.	7096.
102	RAILING	FOOT	116	170.	19720.
103	REMOVE AND RELOCATE BENCH	EACH	1	800.	800.
104	TRANSFORMER PAD	EACH	1	2100.	2100.
105	UNDERGROUND COMED PRIMARY CONDUIT, 4"	FOOT	1,150	11.	12650.
106	CONTINGENCY ALLOWANCE	DOLLAR	50,000		50000.
107	WATER USAGE CREDIT	TGAL	1	0.	0.
108	WATER USAGE DEDUCTION	TGAL	1	0.	0.
109	GEOTEXTILE FABRIC BARRIER	SQ YD	18,070	2.	36140.

Total Base Bid:	1,771,884.⁰⁰
------------------------	--------------------------------

* One million seven hundred and seventy one thousand eight hundred and eighty four dollars + ⁿ/₁₀₀ *

OWNER COPY

CONTRACT

RETURN WITH BID

CONTRACTOR CERTIFICATIONS

County	<u>DuPage</u>
Local Public Agency	<u>Villa Park</u>
Section Number	<u>N/A</u>
Route	<u>Jackson Pond Overflow Project</u>

The certifications hereinafter made by the bidder are each a material representation of fact upon which reliance is placed should the Department enter into the contract with the bidder.

1. **Debt Delinquency.** The bidder or contractor or subcontractor, respectively, certifies that it is not delinquent in the payment of any tax administered by the Department of Revenue unless the individual or other entity is contesting, in accordance with the procedures established by the appropriate revenue Act, its liability for the tax or the amount of tax. Making a false statement voids the contract and allows the Department to recover all amounts paid to the individual or entity under the contract in a civil action.

2. **Bid-Rigging or Bid Rotating.** The bidder or contractor or subcontractor, respectively, certifies that it is not barred from contracting with the Department by reason of a violation of either 720 ILCS 5/33E-3 or 720 ILCS 5/33E-4.

A violation of Section 33E-3 would be represented by a conviction of the crime of bid-rigging which, in addition to Class 3 felony sentencing, provides that any person convicted of this offense or any similar offense of any state or the United States which contains the same elements as this offense shall be barred for 5 years from the date of conviction from contracting with any unit of State or local government. No corporation shall be barred from contracting with any unit of State or local government as a result of a conviction under this Section of any employee or agent of such corporation if the employee so convicted is no longer employed by the corporation and: (1) it has been finally adjudicated not guilty or (2) if it demonstrates to the governmental entity with which it seeks to contract and that entity finds that the commission of the offense was neither authorized, requested, commanded, nor performed by a director, officer or a high managerial agent in behalf of the corporation.

A violation of Section 33E-4 would be represented by a conviction of the crime of bid-rotating which, in addition to Class 2 felony sentencing, provides that any person convicted of this offense or any similar offense of any state or the United States which contains the same elements as this offense shall be permanently barred from contracting with any unit of State or local government. No corporation shall be barred from contracting with any unit of State or local government as a result of a conviction under this Section of any employee or agent of such corporation if the employee so convicted is no longer employed by the corporation and: (1) it has been finally adjudicated not guilty or (2) if it demonstrates to the governmental entity with which it seeks to contract and that entity finds that the commission of the offense was neither authorized, requested, commanded, nor performed by a director, officer or a high managerial agent in behalf of the corporation.

3. **Bribery.** The bidder or contractor or subcontractor, respectively, certifies that it has not been convicted of bribery or attempting to bribe an officer or employee of the State of Illinois or any unit of local government, nor has the firm made an admission of guilt of such conduct which is a matter of record, nor has an official, agent, or employee of the firm committed bribery or attempted bribery on behalf of the firm and pursuant to the direction or authorization of a responsible official of the firm.

4. **Interim Suspension or Suspension.** The bidder or contractor or subcontractor, respectively, certifies that it is not currently under a suspension as defined in Subpart I of Title 44 Subtitle A Chapter III Part 6 of the Illinois Administrative Code. Furthermore, if suspended prior to completion of this work, the contract or contracts executed for the completion of this work may be cancelled.

OWNER COPY

CONTRACT

RETURN WITH BID

SIGNATURES

County DuPage
 Local Public Agency Villa Park
 Section Number N/A
 Route Jackson Pond Overflow

(If an individual)

Signature of Bidder _____

Business Address _____

(If a partnership)

Firm Name _____

Signed By _____

Business Address _____

Inset Names and Addressed of All Partners

{ _____

(If a corporation)

Corporate Name Earth Works Land Improvement & Development Corporation

Signed By [Signature]
President

Business Address 1240 Lyon Rd Babanua IL 60510

Inset Names of Officers

{ President DAN DAVIES
 Secretary DAN DAVIES
 Treasurer DAN DAVIES

Attest:

[Signature]
 Secretary

OWNER COPY

CONTRACT

For Large Purchase Projects (>\$150,000)

**DUPAGE COUNTY COMMUNITY
DEVELOPMENT COMMISSION (CDC) CONDITIONS
FEDERAL GRANT BID MANUAL LANGUAGE AND STATEMENTS**

Please read these conditions carefully and sign the acknowledgement on next page. Note that conditions listed below supersede any other conditions listed elsewhere in the manual. All these conditions apply to any labor providing contractors and any lower level subcontractors.

I. Labor Standards Notice *(also to be listed on the Front Cover)*

FEDERAL LABOR STANDARDS AND DAVIS-BACON PREVAILING WAGE RATES WILL APPLY TO THIS PROJECT.

** Please refer to the Federal Requirements included in the Bid Manual for additional information on federal labor standards and Davis-Bacon prevailing wage requirements.*

II. Bid Security Statement

All bid proposals must be accompanied by a Bid bond, certified check, or bank cashier's check payable to the owner for five percent (5%) of the amount of the bid.

III. Performance and Payment Bond Statement

The successful bidder for the project will be required to enter into Performance and Payment bonds equal to 100% of the bid with approved sureties, which shall be conditioned upon the proper and faithful performance by the contractor of the work specified in accordance with the contract documents.

IV. Brand Name Only Statement

Neither owner nor contractor shall limit materials to only brand-name products. Non-brand name materials of equal specification do qualify and are acceptable.

V. Cost Plus Statement

Cost-plus a percentage of cost and percentage of construction cost methods are prohibited from use on this project in any form or condition.

VI. Change Order Statement

Should change orders be necessary, CDC staff must receive copies and explanation of necessity for review. Should change orders be necessary and they exceed the bonded amount, bonds must be increased to match the new contract total.

VII. Federal Wage Determination Statement

This project is paid for in part with Federal grant funds through the Community Development Block Grant Program. Davis-Bacon Wage Decisions apply and are included in this packet. Davis-Bacon wages are superseded only in instances, by and where Illinois Prevailing Wage

OWNER COPY

CONTRACT

For Large Purchase Projects (>\$150,000)

exceeds Davis-Bacon in wage, fringe benefits, and/or trade stipulations (monetary and/or non-monetary requirements). Should this project not start within 90 days of award, the wage determinations shall be replaced with the most current decision.

VIII. Non-Discrimination Statement

Employers shall not discriminate, directly or indirectly, against employees or applicants for employment on the basis of race, color, religion, sex, national origin, age, familial status, or disability.

IX. WBE/MBE Encouragement Statement *(also to be listed on the Front Cover)*

Minority and Women Owned Business Enterprises (MBE/WBE) are encouraged to submit bids on this Project.

X. Signature Statement

The undersigned is aware that Federal Labor Standards and Davis-Bacon Prevailing Wage Rates apply to all work performed under this contract. It is the contractor's responsibility to comply with these requirements and to assure compliance by his/her subcontractors and any lower tier subcontractors providing labor for said project.

DuPage County Community Development Commission wishes an acknowledgement from the bidder that they have read and understand the conditions listed above.

Please sign below, print your company name, date this document, and submit it with the complete bid package.

Signature: _____ 

Company Name: EARTHWORKS Land Improvement & Development Corporation





Date: 10-30-2018

OWNER COPY

CONTRACT

CONFLICT OF INTEREST DISCLOSURE – CDBG-DR

Please initial each true and applicable statement:

	<p>1. The undersigned understands that this project is being funded with Federal dollars under the Community Development Block Grant – Disaster Recovery (CDBG-DR) Program.</p>
<p>Please select one of the following designations:</p>	
	<p>2. The undersigned has made application to be the owner or developer of a project funded with CDBG-DR.</p>
	<p>3. The undersigned desires to participate as a contractor or subcontractor under a construction project funded with CDBG-DR.</p>
	<p>4. The undersigned has made application to be a subrecipient of DuPage County funding under CDBG-DR.</p>
	<p>5. I am a participant in a CDBG-DR funded buy-out or acquisition of property.</p>
<p>Please select one of the following statements:</p>	
	<p>6. The undersigned hereby certifies that he/she or (if other than an individual) any owners, employees, agents, consultants, officers, or elected or appointed officials (including members of its board of directors) <u>do(es) not have</u> any business or family tie to any current or former employee, agent, consultant, officer, or elected or appointed official of DuPage County. Such a tie includes the following relationships and in-laws of such relationships (whether by blood, marriage or adoption): spouse, parent (including a stepparent), child (including a stepchild), brother, sister (including a stepbrother or stepsister), grandparent, grandchild and no such tie has existed during the past twelve months. All these categories of persons and relations are considered to be “covered persons” under Federal conflict of interest regulations.</p>
	<p>7. The undersigned <u>does have</u> a business or family tie to a current or former (within the last twelve months) employee, agent, consultant, officer, or elected or appointed official of DuPage County. Please note that DuPage County will need to review such business or family tie to determine if it constitutes a conflict of interest under applicable Federal regulations prior to entering into any agreement with you. Please list each such business or family tie:</p>
<p>Please select one of the following statements:</p>	
	<p>8. The undersigned is an individual or sole proprietor and am signing this on behalf of myself.</p>
	<p>9. The undersigned is a partnership and the signature below represents the statement of the partnership and all general and limited partners, individually, and collectively all covered persons associated with the partnership.</p>
	<p>10. The undersigned is a corporation and the signature below is that of a duly authorized corporate officer and represents the statement of each and all covered persons associated with the corporation.</p>

OWNER COPY

CONTRACT

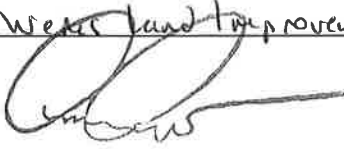
Printed Name:	DAN DAVIES
Title (if applicable):	President
Name of organization (if applicable)	EarthWaters Land Improvement & Development Corporation
Signature:	
Date:	10-30-2018

Printed Name:	
Title (if applicable):	
Name of organization (if applicable)	
Signature:	
Date:	

OWNER COPY

CONTRACT



Illinois Department of Transportation

Local Agency Proposal Bid Bond

RETURN WITH BID

Route Jackson Pond Overflow
County DuPage
Local Agency Villa Park
Section N/A

PAPER BID BOND

WE Earthwerks Land Improvement and Development Corporation as PRINCIPAL, and International Fidelity Insurance Company as SURETY,

are held jointly, severally and firmly bound unto the above Local Agency (hereafter referred to as "LA") in the penal sum of 5% of the total bid price, or for the amount specified in the proposal documents in effect on the date of invitation for bids whichever is the lesser sum.

WHEREAS THE CONDITION OF THE FOREGOING OBLIGATION IS SUCH that, the said PRINCIPAL is submitting a written proposal to the LA acting through its awarding authority for the construction of the work designated as the above section.

THEREFORE if the proposal is accepted and a contract awarded to the PRINCIPAL by the LA for the above designated section and the PRINCIPAL shall within fifteen (15) days after award enter into a formal contract, furnish surety guaranteeing the faithful performance of the work, and furnish evidence of the required insurance coverage, all as provided in the "Standard Specifications for Road and Bridge Construction" and applicable Supplemental Specifications, then this obligation shall become void; otherwise it shall remain in full force and effect.

IN THE EVENT the LA determines the PRINCIPAL has failed to enter into a formal contract in compliance with any requirements set forth in the preceding paragraph, then the LA acting through its awarding authority shall immediately be entitled to recover the full penal sum set out above, together with all court costs, all attorney fees, and any other expense of recovery.

IN TESTIMONY WHEREOF, the said PRINCIPAL and the said SURETY have caused this instrument to be signed by their respective officers this 30th day of October, 2018

Principal Earthwerks Land Improvement and Development Corporation By: DAN DAVIES (Signature and Title) President

(If PRINCIPLE is a joint venture of two or more contractors, the company names, and authorized signatures of each contractor must be affixed.)

Surety International Fidelity Insurance Company By: Carol A. Dougherty (Signature of Attorney-in-Fact)

STATE OF ILLINOIS, COUNTY OF Kane, I, L. DAVIES, a Notary Public in and for said county, do hereby certify that DAN DAVIES, President

who are each personally known to me to be the same persons whose names are subscribed to the foregoing instrument on behalf of PRINCIPAL and SURETY, appeared before me this day in person and acknowledged respectively, that they signed and delivered said instruments as their free and voluntary act for the uses and purposes therein set forth.

Given under my hand and notarial seal this 30th day of October, 2018. My commission expires NOTARY PUBLIC STATE OF ILLINOIS MY COMMISSION EXPIRES MARCH 13, 2020

ELECTRONIC BID BOND

Electronic bid bond is allowed (box must be checked by LA if electronic bid bond is allowed) The Principal may submit an electronic bid bond, in lieu of completing the above section of the Proposal Bid Bond Form. By providing an electronic bid bond ID code and signing below, the Principal is ensuring the identified electronic bid bond has been executed and the Principal and Surety are firmly bound unto the LA under the conditions of the bid bond as shown above.

Electronic Bid Bond ID Code (Company/Bidder Name) (Signature and Title) Date

OWNER COPY

CONTRACT

Surety Company Acknowledgement

STATE OF **ILLINOIS**
COUNTY OF **COOK** SS:

On this **30th day of October, 2018**, before me personally appeared **Carol A. Dougherty**, to me known, who, being by me duly sworn, did depose and say: that (s)he resides at **Schaumburg, Illinois**, that (s)he is the **Attorney in Fact** of **International Fidelity Insurance Company**, the corporation described in and which executed the annexed instrument; that (s)he knows the corporate seal of said corporation; that the seal affixed to said instrument is such corporate seal; that it was so affixed by order of the Board of Directors of said corporation; that (s)he signed his/her name thereto by like order; and that the liabilities of said corporation do not exceed its assets as ascertained in the manner provided by law.



Notary Public in and for the above County and State

My Commission Expires: **06/23/21**



OWNER COPY

CONTRACT



Apprenticeship or Training Program Certification

Return with Bid

Route Jackson Pond Overflow
County DuPage
Local Agency Villa Park
Section N/A

All contractors are required to complete the following certification:

- For this contract proposal or for all groups in this deliver and install proposal.
For the following deliver and install groups in this material proposal:

Blank lines for listing groups in the proposal.

Illinois Department of Transportation policy, adopted in accordance with the provisions of the Illinois Highway Code, requires this contract to be awarded to the lowest responsive and responsible bidder. The award decision is subject to approval by the Department. In addition to all other responsibility factors, this contract or deliver and install proposal requires all bidders and all bidders' subcontractors to disclose participation in apprenticeship or training programs that are (1) approved by and registered with the United States Department of Labor's Bureau of Apprenticeship and Training, and (2) applicable to the work of the above indicated proposals or groups. Therefore, all bidders are required to complete the following certification:

- I. Except as provided in paragraph IV below, the undersigned bidder certifies that it is a participant, either as an individual or as part of a group program, in an approved apprenticeship or training program applicable to each type of work or craft that the bidder will perform with its own employees.
II. The undersigned bidder further certifies for work to be performed by subcontract that each of its subcontractors submitted for approval either (A) is, at the time of such bid, participating in an approved, applicable apprenticeship or training program; or (B) will, prior to commencement of performance of work pursuant to this contract, establish participation in an approved apprenticeship or training program applicable to the work of the subcontract.
III. The undersigned bidder, by inclusion in the list in the space below, certifies the official name of each program sponsor holding the Certificate of Registration for all of the types of work or crafts in which the bidder is a participant and that will be performed with the bidder's employees. Types of work or craft that will be subcontracted shall be included and listed as subcontract work. The list shall also indicate any type of work or craft job category for which there is no applicable apprenticeship or training program available.

Handwritten text: AFL - eio H/H LOCAL ISO

OWNER COPY

CONTRACT

IV. Except for any work identified above, any bidder or subcontractor that shall perform all or part of the work of the contract or deliver and install proposal solely by individual owners, partners or members and not by employees to whom the payment of prevailing rates of wages would be required, check the following box, and identify the owner/operator workforce and positions of ownership.

The requirements of this certification and disclosure are a material part of the contract, and the contractor shall require this certification provision to be included in all approved subcontracts. The bidder is responsible for making a complete report and shall make certain that each type of work or craft job category that will be utilized on the project is accounted for and listed. The Department at any time before or after award may require the production of a copy of each applicable Certificate of Registration issued by the United States Department of Labor evidencing such participation by the contractor and any or all of its subcontractors. In order to fulfill the participation requirement, it shall not be necessary that any applicable program sponsor be currently taking or that it will take applications for apprenticeship, training or employment during the performance of the work of this contract or deliver and install proposal.

Bidder: Earth Works Land Improvement & Development Corporation
Address: 1240 Lyon Rd Babayia IL 60510

By: 
(Signature) DAN DANUS
Title: President

OWNER COPY

CONTRACT

RETURN WITH BID



Affidavit of Illinois Business Office

County DuPage
Local Public Agency Villa Park
Section Number N/A
Route Jackson Pond Overflow

State of Illinois)
County of DuPage) ss.

I, DAN DAVIES of Batavia, IL, (Name of Affiant) (City of Affiant) (State of Affiant)

being first duly sworn upon oath, states as follows:

- 1. That I am the President of EarthWares Land Improvement & Development Corporation
2. That I have personal knowledge of the facts herein stated.
3. That, if selected under this proposal, EarthWares Corporation, will maintain a business office in the State of Illinois which will be located in Kane County, Illinois.
4. That this business office will serve as the primary place of employment for any persons employed in the construction contemplated by this proposal.
5. That this Affidavit is given as a requirement of state law as provided in Section 30-22(8) of the Illinois Procurement Code.

(Signature)
DAN DAVIES
(Print Name of Affiant)

This instrument was acknowledged before me on 30th day of October, 2018.

(SEAL) OFFICIAL SEAL
L DAVIES
NOTARY PUBLIC - STATE OF ILLINOIS
MY COMMISSION EXPIRES MARCH 13, 2020

(Signature of Notary Public)

OWNER COPY

CONTRACT



Illinois Department of Transportation

Bureau of Construction
2300 South Dirksen Parkway/Room 322
Springfield, Illinois 62764

Affidavit of Availability For the Letting of

Jackson Pond Overflow Project

Instructions: Complete this form by either typing or using black ink. "Authorization to Bid" will not be issued unless both sides of this form are completed in detail. Use additional forms as needed to list all work.

Part I. Work Under Contract

List below all work you have under contract as either a prime contractor or a subcontractor. It is required to include all pending low bids not yet awarded or rejected. In a joint venture, list only that portion of the work which is the responsibility of your company. The uncompleted dollar value is to be based upon the most recent engineer's or owners estimate, and must include work subcontracted to others. If no work is contracted, show **NONE**.

	1	2	3	4	Awards Pending	
Contract Number	18-035 DT	16-53	17-58			
Contract With	COUNTY OF DUPAGE	CITY OF EVANSTON	CITY OF EVANSTON			
Estimated Completion Date	2-2019	11-2018	2-2019			
Total Contract Price	2478182	1021652	1612815			Accumulated Totals
Uncompleted Dollar Value if Firm is the Prime Contractor	603597		288584			892181
Uncompleted Dollar Value if Firm is the Subcontractor		956428				956428
Total Value of All Work						1848609

Part II. Awards Pending and Uncompleted Work to be done with your own forces.

List below the uncompleted dollar value of work for each contract and awards pending to be completed with your own forces. All work subcontracted to others will be listed on the reverse of this form. In a joint venture, list only that portion of the work to be done by your company. If no work is contracted, show **NONE**.

					Accumulated Totals
Earthwork		605968			
Portland Cement Concrete Paving					
HMA Plant Mix					
HMA Paving					
Clean & Seal Cracks/Joints					
Aggregate Bases & Surfaces					
Highway, R.R. and Waterway Structures					
Drainage					
Electrical					
Cover and Seal Coats					
Concrete Construction					
Landscaping		17604			
Fencing					
Guardrail					
Painting					
Signing					
Cold Milling, Planning & Rotomilling					
Demolition					
Pavement Markings (Paint)					
Other Construction (List)					
Segmented Block Wall		332856			\$ 0.00
Totals	Ⓞ	956428			956428

Disclosure of this information is **REQUIRED** to accomplish the statutory purpose as outlined in the "Illinois Procurement Code." Failure to comply will result in non-issuance of an "Authorization To Bid." This form has been approved by the State Forms Management Center.

OWNER COPY

CONTRACT

Part III. Work Subcontracted to Others.

For each contract described in Part I, list all the work you have subcontracted to others.

	1	2	3	4	Awards Pending
Subcontractor	Genco Industries		Genco Industries		
Type of Work	Pump Station		Pump Station		
Subcontract Price	797900		332500		
Amount Uncompleted	603597		288584		
Subcontractor					
Type of Work					
Subcontract Price					
Amount Uncompleted					
Subcontractor					
Type of Work					
Subcontract Price					
Amount Uncompleted					
Subcontractor					
Type of Work					
Subcontract Price					
Amount Uncompleted					
Subcontractor					
Type of Work					
Subcontract Price					
Amount Uncompleted					
Total Uncompleted	603597		288584		

I, being duly sworn, do hereby declare that this affidavit is a true and correct statement relating to ALL uncompleted contracts of the undersigned for Federal, State, County, City and private work, including ALL subcontract work, ALL pending low bids not yet awarded or rejected and ALL estimated completion dates.

Subscribed and sworn to before me
 this 30th day of October, 2018

Type or Print Name L DAVIES President
Officer or Director Title

[Signature]
 Notary Public

Signed [Signature]

My commission expires 3-13-2020

Company EarthWorx Land Improvement & Development Corporation

Address 1240 Lyon Rd
Babylon IL 60510



OWNER COPY

CONTRACT

Lora Davies

From: Lora Davies
Sent: Tuesday, October 30, 2018 8:34 AM
To: 'publicworks@invillapark.com'
Subject: Addendum
Attachments: Jackson Pond #1.pdf; Jackson Pond #2.pdf

Good Morning PW-

We, EarthWerks, have received and acknowledge Addendums #1 and #2 as attached for the Jackson Pond Overflow Project.

<https://www.youtube.com/watch?v=gtELVg24FIE>

Lora Davies
Construction Administrator
EARTHWERKS Land Improvement & Development Corp.
1240 Lyon Rd., Batavia, IL, 60510
Office (630) 482-2341
Cell (708) 906-0273
Fax (630) 482-2342



Self discipline means doing what's right, rather than doing what you feel like doing. -e. kipchage



OWNER COPY

CONTRACT

ADDENDUM NO. 1 ACKNOWLEDGMENT FORM

I/We hereby acknowledge receipt of the following documents pertaining to **ADDENDUM No. 1** to the Bidding Documents for the Village of Villa Park's **JACKSON POND OVERFLOW**.

Addendum No. 1	2 pages
Attachments	
1. Plan Sheets	5 pages
2. Bid Book Sheets	4 pages
Acknowledgment Form	1 page
TOTAL	12 pages

Name: DAN DAVIOS

Title: President

Company: EarthWares Land Improvement & Development Corporation

Signature: 

Date: 10-30-2018

OWNER COPY

CONTRACT

ADDENDUM NO. 2 ACKNOWLEDGMENT FORM

I/We hereby acknowledge receipt of the following documents pertaining to **ADDENDUM No. 2** to the Bidding Documents for the Village of Villa Park's **JACKSON POND OVERFLOW**.

Addendum No. 2	2 pages
Attachments	
1. Plan Sheets	5 pages
2. Bid Book Sheets	4 pages
Acknowledgment Form	1 page
TOTAL	12 pages

Name: DAN DAVIET

Title: President

Company: Earth Works Land Improvement & Development Corporation

Signature: 

Date: 10-30-2018

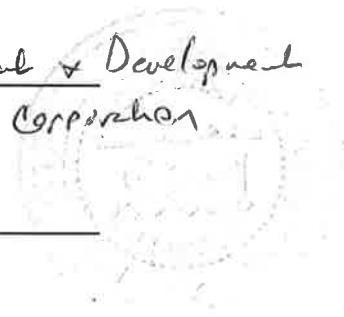

OWNER COPY

CONTRACT



VILLAGE OF VILLA PARK

SPECIAL PROVISIONS

FOR

JACKSON POND OVERFLOW PROJECT

ISSUED FOR BID OCTOBER 13, 2018

PREPARED BY



**7325 JANES AVENUE
WOODRIDGE, ILLINOIS 60517**

OWNER COPY

CONTRACT

INDEX OF SPECIAL PROVISIONS

TITLE	PAGE NO.
SPECIAL PROVISIONS	6
DEFINITIONS	6
LOCATION OF PROJECT	6
DESCRIPTION OF PROJECT	6
 GENERAL SPECIAL PROVISIONS	 8
QUALIFICATIONS OF BIDDERS.....	8
BIDS TO REMAIN SUBJECT TO ACCEPTANCE	11
SUBCONTRACTORS	11
INSURANCE	11
INCREASED OR DECREASED QUANTITIES	12
MOBILIZATION	12
PORTABLE TOILET.....	12
WORKING HOURS.....	12
HOLIDAYS	13
PUBLIC CONVENIENCE AND SAFETY (D-1).....	13
OPERATION OF WATER DISTRIBUTION FACILITIES.....	14
CONSTRUCTION SAFETY AND HEALTH STANDARDS.....	14
FINAL INSPECTION	14
MAINTENANCE WARRANTY.....	15
MAINTENANCE OF ROADWAYS	15
KEEPING ROADS OPEN TO TRAFFIC	16
KEEPING ACCESS TO PRIVATE DRIVEWAYS.....	16
MAINTAINING ACCESS TO THE ISLAMIC FOUNDATION OF VILLA PARK.....	17
RESPONSIBILITY FOR VANDALISM.....	17
USE OF FIRE HYDRANTS	17

TRENCH BACKFILL AND PIPE BEDDING	18
EXCAVATION AND BACKFILLING OF DRAINAGE AND UTILITY STRUCTURES	19
ADJUSTING RINGS.....	19
SALVAGE AND DISPOSAL OF EXISTING MATERIALS	19
FRAMES, GRATES AND LIDS	20
DATE OF MANUFACTURE	21
IRON AND STEEL MATERIALS	21
PROTECTION OF EXISTING DRAINAGE FACILITIES DURING CONSTRUCTION...	21
DROP HAMMERS.....	22
STORM STRUCTURES.....	22
STORM SEWERS.....	22
NOTIFICATION OF RESIDENTS.....	23
ELECTRICAL SERVICE SHUT DOWN COORDINATION OF WILLOWBROOK HIGH SCHOOL	23
REIMBURSEMENT OF UTILITY WORK BY COMED	23
SIGN RELOCATION	24
SAW CUTS	24
STATUS OF UTILITIES (D-1)	24
PAY ITEM SPECIAL PROVISIONS.....	26
PAY ITEM #9 – TOPSOIL FURNISH AND PLACE, 12”	26
PAY ITEM #10 – SEEDING, CLASS 1	26
PAY ITEM #13 – INLET FILTERS.....	27
PAY ITEM #15 – FILTER FABRIC	27
PAY ITEMS #18 AND 19 – PORTLAND CEMENT CONCRETE BASE COURSE	28
PAY ITEM #21 – HOT-MIX ASPHALT SURFACE COURSE, MIX "D", N50	28
PAY ITEM #23 – PORTLAND CEMENT CONCRETE SIDEWALK 5”	29
PAY ITEM #24 – DETECTABLE WARNINGS	29
PAY ITEM #25 – SIDEWALK REMOVAL.....	30
PAY ITEM #35 – ADJUSTING WATER MAIN 6”	31

PAY ITEM #44 – COMBINATION CONCRETE CURB AND GUTTER, TYPE B-6.12..	31
PAY ITEMS #45, 46, 47 – CHAIN LINK FENCE	33
PAY ITEMS #48 AND 49 – CHAIN LINK GATES	34
PAY ITEM #55 – ELECTRIC SERVICE INSTALLATION.....	34
PAY ITEM #60 – REMOVAL OF PEDESTRIAN LIGHT FIXTURE, SALVAGE.....	35
PAY ITEM #61 – REMOVAL OF LIGHTING UNIT, SALVAGE	35
PAY ITEM #68 – IRRIGATION SYSTEM SPECIAL.....	36
PAY ITEM #69 – BENCH REMOVAL.....	58
PAY ITEM #70 – PLAYERS BENCH.....	58
PAY ITEM #71 – PEDESTRIAN TRUSS SUPERSTRUCTURE	59
PAY ITEM #72 – DRAINAGE RESTRICTOR.....	59
PAY ITEM #73 – REMOVE AND REPLACE SIGN AND SUPPORTS.....	59
PAY ITEM #74 – DRAINAGE WEIR.....	60
PAY ITEM #75 – EXPLORATION TRENCH, SPECIAL	60
PAY ITEM #76 – STORM SEWERS, DUCTILE IRON 30”	61
PAY ITEM #77 – TRAFFIC CONTROL AND PROTECTION (SPECIAL).....	62
PAY ITEM #78 – PRECONSTRUCTION VIDEO RECORDING	63
PAY ITEM #79 – CONCRETE REMOVAL (SPECIAL).....	65
PAY ITEM #80 – STABILIZED CONSTRUCTION ENTRANCE.....	65
PAY ITEM #82 – FENCE REMOVAL	66
PAY ITEM #83 – 4’ BY 4’ BOX STRUCTURE.....	66
PAY ITEM #84 – BASEBALL INFIELD MIX	67
PAY ITEM #85 – BASES.....	68
PAY ITEM #86 – BLEACHERS	68
PAY ITEM #87 – BOX PACKING CLAY.....	69
PAY ITEM #88 – COMED PRIMARY SPLICE BOX (INSTALL ONLY)	70
PAY ITEM #89 – CULVERT INLET PROTECTION	70
PAY ITEM #90 – DUGOUT REMOVAL.....	71
PAY ITEM #91 – ELECTRICAL CABINET, COMPLETE	71
PAY ITEM #92 – GRASS PAVERS.....	72

PAY ITEMS #93 AND 94 – GRATING FOR CONCRETE FLARED END SECTION 72
PAY ITEM #95 – LIMESTONE SCREENINGS 73
PAY ITEM #96 – NETTING..... 73
PAY ITEM #97 – PEDESTRIAN LIGHT UNIT, COMPLETE 74
PAY ITEM #98 – PEDESTRIAN LIGHT UNIT, FIXTURE ONLY 75
PAY ITEM #99 – PLASTIC FLARED END SECTION 76
PAY ITEMS #100 AND 101 – PLAYING FIELD SEEDING AND SODDING 76
PAY ITEM #102 – RAILING 77
PAY ITEM #103 – REMOVE AND RELOCATE BENCH..... 78
PAY ITEM #104 – TRANSFORMER PAD..... 78
PAY ITEM #105 – UNDERGROUND COMED PRIMARY CONDUIT, 4” 79
PAY ITEM #106 – CONTINGENCY ALLOWANCE..... 79
PAY ITEM #107 – WATER USAGE CREDIT 80
PAY ITEM #108 – WATER USAGE DEDUCTION..... 81

APPENDIX A

- REQUIREMENTS OF BIDDERS ORDINANCE

APPENDIX B

- IRMA CONTRACTUAL INSURANCE GUIDELINES

APPENDIX C

- INDEX FOR SUPPLEMENTAL AND RECURRING SPECIAL PROVISIONS
- CHECK SHEET FOR RECURRING SPECIAL PROVISIONS
- CHECK SHEET FOR LOCAL ROADS & STREETS RECURRING SPECIAL PROVISIONS
- BDE SPECIAL PROVISIONS
- SPECIAL PROVISION FOR INSURANCE (LR 107-4)
- SPECIAL PROVISION FOR EQUIPMENT RENTAL RATES (LR 109)

APPENDIX D

- IDOT HIGHWAY STANDARDS

APPENDIX E

- STORMWATER POLLUTION PREVENTION PLAN
- NOTICE OF INTENT

APPENDIX F

- FEDERAL REQUIREMENTS

APPENDIX G

- FEDERAL DAVIS-BACON PREVAILING WAGE RATES

SPECIAL PROVISIONS

The following Special Provisions supplement the “Standard Specifications for Road and Bridge Construction”, adopted April 1, 2016 (referred to hereinafter as the Standard Specifications); the “Supplemental Specifications and Recurring Special Provisions”, adopted January 1, 2018; the latest edition of the “Illinois Manual on Uniform Traffic Control Devices For Streets and Highways” (ILMUTCD); and the “Standard Specifications for Water and Sewer Construction in Illinois”, 7th Edition, 2014 (referred to hereinafter as the Water and Sewer Specifications). In case of conflict with any part or parts of said Specifications, these Special Provisions shall take precedence and shall govern. Where no conflict exists, the said Specifications shall apply to this Contract as if repeated in their entirety herein.

DEFINITIONS

Contractor. The individual, firm, partnership, joint venture, or corporation contracting with the Village of Villa Park for performance of prescribed work.

Department, Owner or Village. The Village of Villa Park, DuPage County, Illinois.

Engineer. The Resident Engineer who is the authorized representative of the Village of Villa Park in immediate charge of the engineering details of a construction project.

LOCATION OF PROJECT

The Jackson Pond Overflow Project is located in the Village of Villa Park, DuPage County. The project area is located north and adjacent to Highridge Road from the eastern limit of the Islamic Foundation of Villa Park east to Ardmore Avenue. The total project area is approximately 9.1 acres.

DESCRIPTION OF PROJECT

The Jackson Pond Overflow Project consists of the construction of an overflow detention basin and an overflow channel to that basin on the Village owned property downstream of Jackson Pond, as well as minor expansion of the existing Jackson Pond detention basin itself. The project includes earthwork associated with the overflow basin construction and the existing detention basin expansion; the construction of new storm sewer that discharges to Sugar Creek, along with associated flared end sections, grates, culverts, underdrains, manholes, catch basins, inlets, and headwalls; the replacement of the existing baseball field in order to accommodate the detention basin improvements, along with associated baseball field elements including fences, gates, bleachers, player benches, netting, and irrigation; replacement of the existing

pedestrian sidewalk located in the proposed overflow detention basin with a pedestrian bridge; removal of existing lighting in conflict with construction operations and replacement as necessary; relocation of existing water main located in the proposed overflow detention basin; restoration of existing asphalt and concrete pavements and sidewalks disturbed by construction; fine grading of the entire disturbed area; placement of topsoil; placement of sodding or seed and blanket; construction layout; traffic control and protection; and other necessary related and incidental work.

GENERAL SPECIAL PROVISIONS

QUALIFICATIONS OF BIDDERS

Bidders will comply with all applicable Federal, State and local laws and requirements, and will further meet the qualifications prescribed in this and other applicable portions of these provisions.

Bidder, in submitting a Bid, certifies that Bidder is in compliance with all applicable Federal, State and local laws and requirements, and that Bidder further meets the qualifications prescribed in this and other applicable portions of these provisions. Engineer's determination as to the compliance and qualifications of the Bidder will be final, and Bidder, in submitting a Bid, agrees to be bound by that determination.

Bidder, in submitting a Bid, certifies that Bidder is in compliance with the following requirements and qualifications. Bidder further certifies that Bidder is able to provide written evidence of Bidder's compliance with the following requirements and qualifications. Bidder shall, upon request by Engineer, submit such written evidence within five (5) calendar days of the Engineer's request, as well as any other written evidence which Engineer may deem necessary for the purpose of evaluating Bidder's qualifications.

- (a) Bidder shall be qualified to do business in the State of Illinois.
- (b) Bidder shall possess either a valid Federal Employer Tax Identification Number (FEIN) or a valid Social Security Number (SSN).
- (c) Bidder shall be able to provide a street address and description of the Bidder's place of business, and the mailing address of the business, if different from the street address.
- (d) Bidder shall be able to provide the number of years Bidder has been engaged in the contracting business under the present firm name, and the name of the state where incorporated.
- (e) Bidder shall be able to provide a list of the property and equipment available to the Bidder.
- (f) Bidder shall be able to provide a financial statement demonstrating that the Bidder has the financial resources to meet all obligations related to the Work.
- (g) Bidder shall maintain insurance policies with the coverages required by the Contract, and with the minimum limits of coverage required by the Contract. Bidder shall be able to provide current certificate(s) of insurance for the

insurance policies held by Bidder, demonstrating that Bidder holds insurance policies with the coverages required by the contract, and with the minimum limits of coverage required by the Contract.

- (h) Bidder shall have constructed a minimum of three (3) projects of a similar nature in the immediate past five (5) years. Bidder shall be able to provide a list of all projects of a similar nature constructed by Bidder in the immediate past five (5) years, which list shall contain the minimum of three (3) such projects, which list shall provide a description and the location(s) of all such projects, and shall contain the Bidder's performance record and references, as well as the names and current contact information, including addresses and telephone numbers, of persons who acted as owners' representatives for those projects and who have knowledge of those projects, and whom Bidder agrees the Village may contact for the purpose of verifying Bidder's performance and references.
- (i) Bidder shall be able to provide a list of three (3) references (name, address and telephone number) with knowledge of the integrity and business practices of the bidder. Such references may not be persons who have been employed by Bidder as employees.
- (j) Bidder shall be able to provide a list of projects presently under Contract, the awarded Contract amount of each, the approximate adjusted Contract amount of each (if applicable), and the dollar amount or percent of completion of each.
- (k) Bidder shall be able to provide a list of Contracts which have resulted in lawsuits, whether against Bidder as a prime Contractor, against Bidder as a subcontractor, or against Bidder as a party in any other capacity; or against subcontractors or suppliers performing work for Bidder or under Contract held by Bidder.
- (l) Bidder shall be able to provide a list of Contracts defaulted.
- (m) Bidder shall be able to provide a statement indicating whether or not Bidder has ever filed bankruptcy.
- (n) Bidder shall be able to provide a list of all officers of the firm, which list shall also indicate those officers who, while in the employ of the firm or in the employ of previous firms, were associated with Contracts which resulted in lawsuits, Contracts defaulted, or firms which filed for bankruptcy.
- (o) Bidder shall maintain personnel guaranteed to be employed in the responsible charge of the Work, which personnel possess sufficient technical experience to ensure the satisfactory completion of the Work. Bidder shall be

able to provide the names and technical experience of such personnel, as well as statements as to whether the personnel have or have not performed satisfactorily on other contracts of like nature and magnitude or comparable difficulty at similar rate of progress.

- (p) Bidder shall be able to provide a list of subcontractors and suppliers anticipated to be employed by Bidder for the purpose of completing the Work, including the firm name, street address and description of place of business; mailing address of business (if different); phone, fax and e-mail contact information of business; name of primary contact; and a list of any projects or contracts for which Bidder currently owes monies to said firm, which list shall include a description of the project or contract, the amount currently due to said firm, the period of time for which those monies have been owed, and the expected date of payment of those monies.
- (q) Bidder shall participate in active apprenticeship and training programs approved by and registered with the United States Department of Labor Bureau of Apprenticeship and Training for each of the trades of work contemplated under the Contract. Bidder shall be able to provide evidence of Bidder's participation in such apprenticeship and training programs.
- (r) Bidder shall only employ subcontractors who meet the requirements prescribed in this section and other sections of these specifications.
- (s) Bidder shall be able to provide such other information as may assist the Village in determining whether the Bidder is adequately prepared to fulfill the Contract.

These requirements and qualifications are not intended to discourage bidding, to make it difficult for qualified Bidders to submit Bids, or to discourage beginning Contractors. The purpose of these requirements and qualifications is to allow the Village to obtain sufficient information about Bidder's financial state, available equipment, personnel, and previous work experience so that the Village may mitigate the hazards involved in awarding contracts to parties who may not be qualified to perform the Work as specified.

A copy of the Village of Villa Park Ordinance No. 3733, amending the requirements of bidders for construction projects, is provided as Appendix A.

BID PRICE LIMITATIONS

The bid price for TRAFFIC CONTROL AND PROTECTION shall not exceed 5 percent of the total bid price. If the bid price for TRAFFIC CONTROL AND PROTECTION exceeds 5 percent of the total bid price, the Village may reject the Bid.

The bid price for CONSTRUCTION LAYOUT shall not exceed 2 percent of the total bid price. If the bid price for CONSTRUCTION LAYOUT exceeds 2 percent of the total bid price, the Village may reject the Bid.

The bid price for PRE-CONSTRUCTION VIDEO RECORDING shall not exceed 1 percent of the total bid price. If the bid price for PRE-CONSTRUCTION VIDEO RECORDING exceeds 1 percent of the total bid price, the Village may reject the Bid.

Bidder, in submitting a Bid, certifies that the Bid is in compliance with these requirements. The Village's determination as to whether or not to reject a Bid that does not comply with these requirements will be final, and Bidder, in submitting a Bid, agrees to be bound by that determination.

BIDS TO REMAIN SUBJECT TO ACCEPTANCE

All bids shall remain subject to acceptance by the Village for a period of 60 calendar days from the date of the bid opening. The Village may extend the acceptance period by up to an additional 60 calendar days upon written notice to all bidders by the Village. The Village may, in its sole discretion, release any bid and return the bid bond prior to the end of the acceptance period.

SUBCONTRACTORS

Add the following paragraph to the end of Article 108.01 of the Standard Specifications:

“The apparent low Bidder shall submit to the Village within 7 calendar days after the receipt of bids, a list of the names of Bidder's proposed subcontractors and material suppliers along with a description of the work to be performed or the materials to be supplied by each.”

INSURANCE

Insurance and indemnification shall be in accordance with applicable sections of the Standard Specifications, and shall also be in accordance with the “IRMA Contractual Insurance Guidelines”, incorporated herein as Appendix B. If a conflict is determined to exist between the requirements prescribed in the Standard Specifications and the requirements prescribed in the IRMA Contractual Insurance Guidelines, such conflict will be resolved as follows:

- a. If a particular type of insurance coverage is required by one standard but not by both, that type of insurance coverage will be required.

- b. If the minimum limits of insurance coverage required by one standard differ from those required by the other standard, the higher minimum limits of insurance coverage will prevail.
- c. If any other conflicts are determined to exist between the requirements prescribed in the two standards, the stricter of the two requirements will prevail. The Village will make the final determination as to what constitutes a stricter requirement.

INCREASED OR DECREASED QUANTITIES

The Village reserves the right to increase or decrease the amount of work shown in the plans in accordance with Section 109 of the Standard Specifications.

MOBILIZATION

Mobilization shall be in accordance with Section 671 of the Standard Specifications, except as modified herein.

Revise Article 671.02, Basis of Payment, to read:

“671.02 Basis of Payment. This work will not be paid for separately but shall be included in the unit bid prices of the items for which this work applies.”

PORTABLE TOILET

Contractor shall furnish a portable toilet meeting Federal, State and local health department requirements stocked with lavatory and sanitary supplies at all times. The portable toilet shall be provided at a location approved by the Engineer. The portable toilet shall be maintained in a clean and sanitary condition and shall be emptied as needed. This work will not be paid for separately but shall be included in the cost of the contract.

WORKING HOURS

Working hours will be between 7:00 A.M. and 5:00 P.M., Monday through Friday, excluding holidays as designated by the Contract.

Contractor will not permit the performance of Work outside these working hours without Owner's written consent, which may be given after prior written request to Engineer,

except as otherwise required for the safety of persons or the Work or property at the Site or adjacent thereto, and except as otherwise stated in the Contract Documents.

If Contractor permits the performance of Work outside these working hours, Contractor will compensate Owner for the costs of inspection and other services provided by Engineer. Owner will determine the rates at which such inspection and other services are to be compensated. Owner will determine the interval or intervals at which billing will take place, and may, at Owner's discretion, submit invoices for payment to Contractor, or deduct the costs from any monies due or to become due to the Contractor from Owner.

HOLIDAYS

Revise the list of legal holidays in Article 107.09 of the Standard Specifications to read:

New Year's Day	Hijra – Islamic New Year
Easter	Day of Ashur / Muharram (Islamic Holiday)
Memorial Day	Milad un Nabi (Islamic Holiday)
Independence Day	Thanksgiving Day
Waqf al Arafa – Hajj (Islamic Holiday)	Thanksgiving Friday
Eid al-Adha (Islamic Holiday)	Christmas Eve
Labor Day	Christmas Day
	New Year's Eve

PUBLIC CONVENIENCE AND SAFETY (D-1)

Effective: May 1, 2012

Revised: July 15, 2012

Add the following to the end of the fourth paragraph of Article 107.09:

“If the holiday is on a Saturday or Sunday, and is legally observed on a Friday or Monday, the length of Holiday Period for Monday or Friday shall apply.”

Add the following sentence after the Holiday Period table in the fourth paragraph of Article 107.09:

“The Length of Holiday Period for Thanksgiving shall be from 5:00 AM the Wednesday prior to 11:59 PM the Sunday After”

Delete the fifth paragraph of Article 107.09 of the Standard Specifications:

“On weekends, excluding holidays, on roadways with Average Daily Traffic of 25,000 or greater, all lanes shall be open to traffic from 3:00 P.M. Friday to midnight Sunday except where structure construction or major rehabilitation makes it impractical.”

OPERATION OF WATER DISTRIBUTION FACILITIES

Contractor shall not operate any water distribution facilities, including, but not limited to, valves or hydrants. If Contractor requires the operation of such facilities, Contractor shall provide a minimum of 48 hours notice to the Village and the Village will operate such facilities.

CONSTRUCTION SAFETY AND HEALTH STANDARDS

It is a condition of this contract and shall be made a condition of each subcontract entered into pursuant to this contract that the Contractor and any Subcontractor shall not require any laborer or mechanic employed in performance of that contract to work in surroundings or under working conditions which are unsanitary, hazardous or dangerous to their health or safety, as determined under Federal Construction Safety and Health Standards.

FINAL INSPECTION

Final inspection shall be in accordance with Article 105.13 of the Standard Specifications, except as modified herein.

Revise the second paragraph of Article 105.13, Final Inspection, to read:

“If the inspection discloses any work, in whole or in part, as being unsatisfactory, the Engineer will give the Contractor the necessary instructions for correction of same, and the Contractor shall comply with such instructions within 14 calendar days of receipt of such instructions. The Contractor shall give the Engineer not less than 48 hours notice, in writing, prior to beginning any such corrective work. Upon completion of all corrective work, the Contractor shall give the Engineer notice in writing. Upon receipt of such notice, the Engineer will make another inspection which shall constitute the final inspection provided the work has been satisfactorily completed. In such event, the Engineer will notify the Contractor in writing of the date of final inspection.”

MAINTENANCE WARRANTY

The Contractor shall execute and deliver to the Village, before final payment will be issued, a written warranty, in a form satisfactory to the Village, which guarantees that all work is in accordance with the contract and will not be defective. This warranty shall guarantee all work for a period of 1 year from the date of final inspection.

The Contractor shall furnish a warranty bond in an amount equal to 10 percent of the final contract amount by a surety satisfactory to the Village to guarantee Contractor's warranty to repair defective work.

If, within the warranty period, the Village determines any work to be defective, a written notice of such deficiency will be sent to the Contractor by certified mail.

The Contractor shall, within 14 calendar days of receipt of the notice of deficiency, and without cost to the Village, correct or repair such defective work, or remove and replace the defective work in accordance with the contract requirements for the item or items in question.

If Contractor desires an extension of time to complete the corrective work, Contractor shall make such request in writing within 10 calendar days of receipt of the notice of deficiency. After the Contractor has filed a request for an extension of time, the Village will notify the Contractor, in writing, whether or not such extension will be approved.

Should the Contractor fail to complete the corrective work within the 14 calendar days or within such extended time as may have been allowed, the Contractor shall be liable and shall pay to the Village the amount shown in the Schedule of Deductions for Each Day of Overrun in Contract Time, not as a penalty but as liquidated damages, for each day of overrun beyond the 14 calendar days or such extended time as may have been allowed.

MAINTENANCE OF ROADWAYS

Effective: September 30, 1985

Revised: November 1, 1996

Beginning on the date that work begins on this project, the Contractor shall assume responsibility for normal maintenance of all existing roadways within the limits of the improvement. This normal maintenance shall include all repair work deemed necessary by the Engineer, but shall not include snow removal operations. Traffic control and protection for maintenance of roadways will be provided by the Contractor as required by the Engineer.

If items of work have not been provided in the contract, or otherwise specified for payment, such items, including the accompanying traffic control and protection required by the Engineer, will be paid for in accordance with Article 109.04 of the "Standard Specifications".

KEEPING ROADS OPEN TO TRAFFIC

All roads and driveways shall remain open to traffic unless otherwise shown on the contract plans. When necessary to close one lane because of construction, the Contractor shall maintain one-way traffic during construction hours with the use of signs and flaggers as shown on the Traffic Control Standards.

Contractor shall be aware that Highridge Road and Ardmore Avenue are the main points of access for the Islamic Foundation of Villa Park and Willowbrook High School. The Islamic Foundation of Villa Park conducts religious services on Fridays that significantly impact the traffic on Highridge Road and Ardmore Avenue. No lane closures on Highridge Road or Ardmore Avenue are permitted during the following times without approval from Village:

- Mondays: School days from 8:00 am to 9:15 am and from 2:30 pm to 3:30 pm
- Tuesday – Thursday: School days from 6:45 am to 8:00 am and from 2:30 pm to 3:30 pm
- Friday: No lane closures allowed.
- The first week of school for Willowbrook High School (Monday, August 13 to Friday August 17)

Any wholes left open at the end of the workday shall be protected and plated in accordance with the IDOT Standard Specifications. The cost of this work shall not be paid for separately and is considered incidental to the cost of the contract.

KEEPING ACCESS TO PRIVATE DRIVEWAYS

Access to private driveways shall be provided at all times except during actual construction adjacent there to. Temporary ramps shall be constructed as needed to provide such access, utilizing crushed stone or crushed gravel as temporary access. This work shall be incidental to the cost of the contract.

MAINTAINING ACCESS TO THE ISLAMIC FOUNDATION OF VILLA PARK

The Contractor shall be responsible for maintaining vehicular and pedestrian access to the Islamic Foundation of Villa Park and at the intersection of Highridge Road and the entrance road to Willowbrook High School. The Contractor shall coordinate with the Islamic Foundation of Villa Park at least 14 days prior to the start of construction at the intersection. The maintenance of access may include, but is not limited to: staged construction, sidewalk detours, and completing the work outside of the Islamic Foundation of Villa Park's peak hours of traffic. Maintaining access to the Islamic Foundation of Villa Park will not be paid for separately but shall be included in the cost of the contract.

RESPONSIBILITY FOR VANDALISM

The Contractor shall be responsible for the protection of all equipment and materials. Any equipment or materials which are stolen, missing, lost, damaged or vandalized shall be the Contractor's responsibility to replace or repair as needed at no additional cost to the contract.

The Contractor shall be responsible for the defacement of any concrete pours before they have set up. Concrete pavement, sidewalk, driveway, or curbing that has been defaced, in the opinion of the Engineer, shall be removed and replaced by the Contractor at Contractor's expense.

USE OF FIRE HYDRANTS

Revise Article 107.18, Use of Fire Hydrants, of the Standard Specifications to read:

“107.18 Use of Fire Hydrants. If Contractor requires water for the completion of construction operations, and desires to obtain water from the Village, the Contractor shall make written application to the Village. If such application is approved by the Village, the Contractor shall obtain water from the fire hydrant located at 100 West Home Avenue, adjacent to the Village of Villa Park Fleet Maintenance Garage. Contractor's use of said hydrant and methods of obtaining water shall be in compliance with all applicable ordinances, rules, and regulations concerning such use. Contractor shall furnish all labor and equipment necessary to make a connection to said hydrant, and to obtain and transport water.

Prior to obtaining water, Contractor shall make written application to the Village for temporary use of a hydrant meter. If the application for temporary use of a hydrant meter is approved, the Contractor shall provide a deposit of three-thousand dollars (\$3,000.00) to the Village for the temporary use of said hydrant meter, which deposit will be held by the Village until such time that the meter is returned to the Village by the

Contractor in satisfactory condition. Contractor shall use said hydrant meter when obtaining water, and shall comply with all conditions for the use of said meter. Contractor shall return the hydrant meter to the Village within 24 hours of project completion and within 24 hours of any request by the Village that the hydrant meter be returned.

If Contractor makes application for temporary use of a hydrant meter and the application is not approved, Contractor shall make record of the quantity of water obtained, along with the date and time obtained, and shall report such information after each use to the Village of Villa Park Public Works Department, 11 West Home Avenue. If such use takes place outside of the normal working hours of the Public Works Department, Contractor shall report such information immediately upon the commencement of normal working hours.

Contractor shall not use, operate or obtain water from any hydrants other than the hydrant prescribed. Contractor shall not obtain water from the Village for construction operations or activities not under contract with the Village.

If a water main break occurs and the Village determines that the water main break is a result of Contractor's use of a hydrant, the Village may require the Contractor to repair the water main break in accordance with all applicable construction standards and requirements and at no cost to the contract, or may repair the water main break by other means and invoice the Contractor for reimbursement of the Village's costs.

Water usage will be measured according to the Special Provisions WATER USAGE DEDUCTION and WATER USAGE CREDIT."

TRENCH BACKFILL AND PIPE BEDDING

All trench backfill and pipe bedding materials furnished under this contract shall be virgin, non-recycled materials.

Trench backfill shall be CA-6 and installed per Method 1 outlined in section 550.07 of the Standard Specifications. Pipe bedding shall be CA-7 or CA-11 and installed per section 550.04 of the Standard Specifications.

Trench backfill shall be installed up to finished grade. Backfill will be removed under a separate item down to the lower extent of the pavement section when pavement patching is installed.

EXCAVATION AND BACKFILLING OF DRAINAGE AND UTILITY STRUCTURES

Excavation, bedding and backfilling of drainage and utility structures which are constructed, reconstructed, or adjusted as a part of this contract will not be paid for separately but shall be included in the cost of the items to which this work pertains.

ADJUSTING RINGS

All drainage and utility structures which are constructed, reconstructed, or adjusted as a part of this contract shall have adjusting rings installed between the topmost section of the structure and the casting.

Each structure shall be fitted with a minimum of one adjusting ring and a maximum of two adjusting rings. The topmost adjusting ring on each structure shall be rubber. The second adjusting ring on each structure, if needed, shall be precast concrete with steel reinforcement. The total height of all adjusting rings on a single structure shall be a minimum of 2 in. and a maximum of 12 in.

The mating faces of adjusting rings shall be smooth, parallel, and free of cracks, chips, spalling, or casting irregularities. Rubber mastic shall be installed between each joint.

Adjusting rings will not be paid for separately but shall be included in the cost of the items to which this work pertains.

SALVAGE AND DISPOSAL OF EXISTING MATERIALS

Existing manufactured materials which are removed and are not to be reused, including, but not limited to, frames, grates, lids, castings, sign posts, sign panels, fire hydrants, valves, stops, and fittings, shall remain the property of the Village unless the Engineer waives this requirement as specified herein.

Existing manufactured materials which are removed and are not to be reused will be inspected by the Engineer. Materials which are determined by the Engineer to be in satisfactory condition shall remain the property of the Village and shall be delivered by the Contractor to the Village of Villa Park Public Works Department yard located at 51 South Ardmore Avenue in Villa Park. Delivery shall be made during the normal working hours of the Village of Villa Park Public Works Department and the Contractor shall coordinate the day, time, and other details of delivery with the Village.

Materials which are determined by the Engineer to be in unsatisfactory condition shall become the property of the Contractor and shall be removed from the site by the end of the workday and properly disposed of by the Contractor.

The delivery or disposal of materials will not be paid for separately but shall be included in the cost of all items that include removal of existing materials.

FRAMES, GRATES AND LIDS

Frames, grates, lids and all other castings furnished under this contract shall be in accordance with Section 602 and Section 604 of the Standard Specifications, except as modified herein.

Castings shall conform to ASTM A48 Class 30. Castings shall be free of cracks, holes, swells, cold shuts, and patches. Castings shall not be coated or painted.

Frames, grates, lids and other castings shall be furnished in accordance with the following:

Type 1 frames and closed lids shall be Neenah R-1713 self-sealing or approved equal.

Type 1 frames and open lids shall be Neenah R-1713 or approved equal.

Type 11 frames and grates located in barrier curb and gutter shall be Neenah R-3281-A with curb box or approved equal.

Type 11 frames and grates located in depressed curb and gutter shall be Neenah R-3281-A with depressed curb grate or approved equal.

All other castings not specified above shall be as shown on the plans or as directed by the Engineer. If any of the castings specified are not compatible in the field due to frame height or other constraints, the Contractor shall propose an alternate casting to the Engineer for approval and shall furnish the alternate casting if approved.

Frames, grates, lids and other castings located within curb ramps or crosswalks shall be substituted with ADA compliant castings.

All closed lid castings furnished under this contract shall be self-sealing, gasketed, watertight, and shall have machined bearing surfaces and concealed pick holes. The top surface of all closed lids shall be embossed with the words "VILLAGE OF VILLA PARK". The top surface of closed lids shall also be embossed with the word "SANITARY", "STORM", or "WATER" as appropriate.

Enviro-curb logos on curb boxes for Type 11 frames and grates shall have the words "DUMP NO WASTE" and "DRAINS TO RIVER" or "DRAINS TO WATERWAY" cast into the top of all curb boxes.

This work will not be paid for separately but shall be included in the cost of all pay items that include the furnishing of frames, grates, lids, or other castings.

DATE OF MANUFACTURE

All manufactured materials furnished under this contract, including, but not limited to, frames, grates, lids, castings, fire hydrants, pipe, drainage and utility structures, valves, stops, and fittings, shall have been manufactured no earlier than January 1 of the calendar year in which they are to be installed.

IRON AND STEEL MATERIALS

All iron and steel materials furnished under this contract shall be domestically manufactured or produced and fabricated in accordance with Article 106.01 of the Standard Specifications.

PROTECTION OF EXISTING DRAINAGE FACILITIES DURING CONSTRUCTION

Unless otherwise noted in the contract plans, the existing drainage facilities shall remain in use during the period of construction.

Locations of existing drainage structures and sewers, if shown on the contract plans, are approximate. Prior to commencement of work, the Contractor, at his/her own expense, shall determine the exact location of existing structures which are within the proposed construction site.

All drainage structures are to be kept free from any debris resulting from construction operations. All work and materials necessary to prevent accumulation of debris in the drainage structure resulting from construction operations shall be removed at the Contractor's own expense, and no extra compensation will be allowed.

Unless reconstruction or adjustment of an existing manhole, catch basin, or inlet is called for in the contract plans or ordered by the Engineer, the proposed work shall meet the existing elevations of these structures. Should reconstruction or adjustment of a drainage structure be required by the Engineer in the field, the necessary work and payment shall be done in accordance with Section 602 and Article 104.02 respectively, of the Standard Specifications.

Existing frames and grates are to remain unless otherwise noted in the contract plans or as directed by the Engineer. Frames and grates that are missing or damaged prior to construction shall be replaced. The type of replacements frame or grate shall be determined by the Engineer, and replacement and payment for same shall be in

accordance with Section 604 and Article 104.02 respectively, of the Standard Specifications unless otherwise noted in the plans or special provisions.

DROP HAMMERS

The use of drop hammers or similar equipment will not be permitted.

STORM STRUCTURES

All catch basins, manholes, box structures, inlets and drainage structures installed under this contract shall be in accordance with Section 602 of the Standard Specifications, except as modified herein. Unless otherwise noted, the proposed catch basin, manholes, box structures, inlets and drainage structures shall be Precast Reinforced Concrete (per Section 1042 of the Standard Specifications).

This work will be paid for at the contract unit price per EACH for catch basins, manholes and inlets with the appropriate frames, grates and lids.

Any removals (i.e. pavement, curb and gutter, sidewalk, aggregate shoulder, etc.) associated with the installation of storm structures with the exception of tree removal shall be included in the cost of the new sewer and will not be paid for separately. Removals shall be performed per IDOT Standard Specifications.

STORM SEWERS

All storm sewers installed under this contract shall be in accordance with Section 550 of the Standard Specifications, except as modified herein. Unless otherwise noted, the proposed storm sewer shall be Precast Reinforced Concrete (per Section 1042 of the Standard Specifications).

This work will be paid for at the contract unit price per FOOT for storm sewers.

The cost of making any sewer connections to existing drainage structures or pipe shall be included in the cost of the new sewer pipe or structure. Any additional storm sewer pipe required to make the connection shall be of the same size and material type as the existing storm sewer. Clay pipe and other substandard materials as determined by the engineer will not be replaced in kind but shall be replaced with suitable materials. This work and the necessary materials shall be included in the cost of the new sewer or structure.

All temporary storm sewer plugs and temporary storm sewer connections required for construction staging shall be included in the cost of the storm sewer.

Any removals (i.e. pavement, curb and gutter, sidewalk, aggregate shoulder, etc.) associated with the installation of storm sewer with the exception of tree removal shall be included in the cost of the new sewer and will not be paid for separately. Removals shall be performed per IDOT Standard Specifications.

NOTIFICATION OF RESIDENTS

The Contractor shall be responsible for notifying residents and adjacent properties of project schedule, driveway closures, utility disconnects, irrigation system conflicts in the parkway, landscape and hardscape conflicts, and any other construction operations that may disrupt the neighborhood. The Contractor shall coordinate with the Village on the notification process, content, and lead times within 7 days of being awarded the contract. The notification process may include, but is not limited to: door to door in person notification, flyers delivered in person or sent via certified mail, and neighborhood meetings. Notification of Residents will not be paid for separately but shall be included in the cost of the contract.

ELECTRICAL SERVICE SHUT DOWN COORDINATION OF WILLOWBROOK HIGH SCHOOL

The electrical service to Willowbrook High School is required to be shut down for the proposed connection of the electrical service in this contract. The Contractor shall be responsible for coordinating with ComEd and the Village on the notification process of Willowbrook High School within 7 days of being awarded the contract. The coordination process may include, but is not limited to: coordinating directly with ComEd and Willowbrook High School, scheduling the shut down during a school break period (winter break or spring break), and modifying the construction schedule to meet Willowbrook High School's shut down requirements. Electrical Service Shut Down Coordination will not be paid for separately but shall be included in the cost of the contract.

REIMBURSEMENT OF UTILITY WORK BY COMED

The Contractor shall be responsible for coordinating, scheduling, and payment of the utility work that is to be performed by ComEd. The contractor will be reimbursed for the actual invoice cost paid to ComEd for the work. The Contractor shall submit the ComEd invoice and plans to the Village prior to payment being made to ComEd and the start of the ComEd work for Village approval. The Contractor will be reimbursed once the ComEd work is complete and approved by the Village. The contractor will not be compensated for any delays or schedule changes caused by the work that is to be performed by ComEd. This shall include any coordination, scheduling and payment necessary for bracing that may be required for storm sewer installation. All coordination

and scheduling performed by the Contractor for the utility work by ComEd will not be paid for separately but shall be included in the cost of the contract.

SIGN RELOCATION

All existing signs that need to be temporarily removed as part of the construction process or relocated due to location of proposed curb are to be reinstalled at the same station. Sign relocation, assembly removal, storage, temporary signing, and reinstallation to be included in the cost of TRAFFIC CONTROL AND PROTECTION (SPECIAL).

This applies to all signs except the decorative sign located on High Ridge Road that reads "Willowbrook Park" which will be paid for as REMOVE AND REPLACE SIGN AND SUPPORTS.

SAW CUTS

Full depth saw cuts are required at all pavement removal limits. All saw cuts performed during the construction process will not be paid for separately but shall be included in the cost of the removal item adjacent to the saw cut.

STATUS OF UTILITIES (D-1)

Effective: June 1, 2016

Utility companies and/or municipal owners located within the construction limits of this project have provided the following information in regard to their facilities and the proposed improvements. The tables below contain a description of specific conflicts to be resolved and/or facilities which will require some action on the part of the Department's Contractor to proceed with work. Each table entry includes an identification of the action necessary and, if applicable, the estimated duration required for the resolution.

UTILITIES TO BE ADJUSTED

Conflicts noted below have been identified by following the suggested staging plan included in the contract. The company has been notified of all conflicts and will be required to obtain the necessary permits to complete their work; in some instances resolution will be a function of the construction staging. The responsible agency must relocate or complete new installations as noted in the action column; this work has been deemed necessary to be complete for the Department's Contractor to then work in the stage under which the item has been listed.

STAGE / LOCATION	TYPE	DESCRIPTION	RESPONSIBLE AGENCY	ACTION
Pre-Stage-Proposed Swale at approximately 5 feet east of the Pedestrian Bridge	Water	6-inch Water Main	Villa Park Public Works	The Contractor shall coordinate relocation and adjustment of water main under proposed swale.
Post Mass Grading-Proposed 3 Phase Electrical Service. Right outfield of the baseball diamond.	Electric	1200 AMP 208/120V 3 Phase Service	ComEd	The Contractor shall coordinate the proposed electrical service with ComEd, Willowbrook High School and the Village.

The following contact information is what was used during the preparation of the plans as provided by the Agency/Company responsible for resolution of the conflict.

Agency/Company Responsible to Resolve Conflict	Name of contact	Address	Phone	e-mail address

PAY ITEM SPECIAL PROVISIONS

PAY ITEM #9 – TOPSOIL FURNISH AND PLACE, 12”

Description. This work shall consist of furnishing and placing a minimum of 12 inches of topsoil on all disturbed areas that will be vegetated in accordance with Section 211 of the Standard Specifications, except as modified herein.

In areas that will be finished with the infield mix, contractor shall furnish 8 inches of topsoil underneath the infield mix. This topsoil shall be paid for as BASEBALL INFIELD MIX.

Method of Measurement. This work will be measured for payment in place and the area computed in square yards.

Basis of Payment. This work will be paid for at the contract unit price per square yard for TOPSOIL FURNISH AND PLACE, 12”.

PAY ITEM #10 – SEEDING, CLASS 1

Description. This work shall consist of seeding per Section 250 of the Standard Specifications, except as modified herein.

Fertilizer shall include Nitrogen Fertilizer Nutrients and Potassium Fertilizer Nutrients and shall be incidental to the cost of SEEDING, CLASS 1. Phosphorus fertilizer nutrients shall not be used. The fertilizer shall be installed per Section 250.04 of the standard specifications.

In areas that will be finished with the infield mix, contractor shall furnish 8 inches of topsoil underneath the infield mix. This topsoil shall be paid for as BASEBALL INFIELD MIX.

Method of Measurement. This work will be measured for payment in place and the area computed in square yards.

Basis of Payment. This work will be paid for at the contract unit price per square yard for TOPSOIL FURNISH AND PLACE, 12”.

PAY ITEM #13 – INLET FILTERS

Description. This work shall consist of installing, maintaining and cleaning inlet filters as shown on the plans or as directed by the Engineer. This work shall be in accordance with Section 280 of the Standard Specifications, except as modified herein.

Inlet filters shall consist of metal frames with attached fabric bags. Contractor shall furnish inlet filters of appropriate sizes and shapes necessary to accommodate all different types of drainage structures encountered. The use of filter fabric without a frame will not be an acceptable material for inlet filters and will be rejected.

Contractor shall inspect and clean all inlet filters weekly, after every rainfall, and additionally as needed. Maintenance and cleaning of inlet filters will not be paid for separately but shall be included in the cost of this work.

Method of Measurement. This work will be measured for payment as each individual inlet filter installed and the unit of measurement will be each. No measurement will be made of maintenance and cleaning efforts. If an inlet filter is installed on multiple structures the inlet filter will only be measured for payment once.

Basis of Payment. This work will be paid for at the contract unit price per each for INLET FILTERS.

PAY ITEM #15 – FILTER FABRIC

Description. This work shall consist of furnishing and installing filter fabric as specified in the plans. This work shall be in accordance with Section 282 of the Standard Specifications, except as modified herein:

Material shall meet Section 1080.03 of the Standard Specification for Gradation 4 stone.

The filter fabric material shall be a nonwoven fabric. The fabric shall be formed in widths of no less than 6 ft. The texture of the fabric shall be such that the bedding and riprap will remain in an equilibrium and not slip or slide.

Physical Property	Requirement
Weight of Fabric (oz/sq yd), ASTM D3776 (Mod)	6.0
Burst Strength (psi), ASTM D 3786	250
Trapezoidal Tear Strength (lb), ASTM D5733	60
Grab Tensile Strength (lb), ASTM 4632	160
Grab Tensile Elongation (%), ASTM D 4632	20

Method of Measurement. This work shall be measured for payment in place and the area computed in square yard.

Basis of Payment. This work will be paid for at the contract unit price per square yard for FILTER FABRIC.

PAY ITEMS #18 AND 19 – PORTLAND CEMENT CONCRETE BASE COURSE

Description. This work shall consist of portland cement concrete base course as specified in the plans. This work shall be in accordance with Section 353 of the Standard Specifications, except as modified herein:

This work shall include removal of trench backfill down to a depth required for the installation of the full pavement section.

Method of Measurement. This work will be measured for payment in accordance with Section 353 of the Standard Specifications with the following revisions.

Basis of Payment. This work will be paid for at the contract unit price per square yard for PORTLAND CEMENT CONCRETE BASE COURSE at the thickness specified.

PAY ITEM #21 – HOT-MIX ASPHALT SURFACE COURSE, MIX "D", N50

Description. This work shall consist of furnishing and installing Portland Cement Concrete Sidewalk 5". This work shall be in accordance with Section 406 of the Standard Specifications, except as modified herein:

Any anti-stripping additive required shall be included in the cost of the surface course.

Method of Measurement. This work shall be measured for payment in place and the area computed in TON.

Basis of Payment. This work will be paid for at the contract unit price per ton for HOT-MIX ASPHALT SURFACE COURSE, MIX "D", N50.

PAY ITEM #23 – PORTLAND CEMENT CONCRETE SIDEWALK 5”

Description. This work shall consist of placing Portland Cement Concrete Sidewalk 5”. This work shall be in accordance with Section 424 of the Standard Specifications, except as modified herein:

The sidewalk is to be placed on mechanically compacted Aggregate Base Course, Type B, 4”. Aggregate Base Course, Type B, 4” will not be paid for separately, but shall be included in the cost of PORTLAND CEMENT CONCRETE SIDEWALK 5”.

The sidewalk is to be thickened to 6” at locations where the sidewalk crosses residential driveways. Where the sidewalk crosses commercial driveways it shall be thickened to 8”. The sidewalk through driveways will not be paid for separately, but shall be included in the cost of PORTLAND CEMENT CONCRETE SIDEWALK 5”.

The sidewalk is to be thickened to 10” at locations where railing is installed within the sidewalk. Any additional reinforcing steel as shown in the construction detail shall be included. The sidewalk with railing will not be paid for separately, but shall be included in the cost of PORTLAND CEMENT CONCRETE SIDEWALK 5”. The railing itself will be paid for as RAILING.

Method of Measurement. This work shall be measured for payment in place and the area computed in square feet.

Basis of Payment. This work will be paid for at the contract unit price per square foot for PORTLAND CEMENT CONCRETE SIDEWALK 5”.

PAY ITEM #24 – DETECTABLE WARNINGS

Description. This work shall consist of furnishing and installing detectable warnings. This work shall be in accordance with Section 424 of the Standard Specifications, except as modified herein.

Detectable warnings shall be installed at curb ramps and other locations where pedestrians are required to cross a hazardous vehicular way. Detectable warnings shall also be installed at alleys and commercial entrances where permanent traffic control devices are present.

Materials. Detectable warnings shall be pre-cast tiles. Installation shall be cast-in-place. Surface mounted applications will not be permitted. Detectable warnings shall be red in color. Detectable warning tiles shall be either rectangular or radial in shape as shown on the plans or as directed by the Engineer. The product or products to be used for detectable warnings shall be approved by the Engineer prior to use.

Construction. Installation shall be according to the manufacturer's specifications and as directed by the Engineer.

Where a curb ramp is 5 ft. in width or less and a rectangular detectable warning tile is to be used, the installation shall consist of a single detectable warning tile. If a pre-cast detectable warning tile is not manufactured in the width of the curb ramp, a larger detectable warning tile shall be furnished and shall be cut to the width of the curb ramp.

Installation of multiple detectable warning tiles at a single curb ramp will only be permitted where a curb ramp exceeds 5 ft. in width or where radial detectable warning tiles are to be used. Where multiple detectable warning tiles are permitted at a single curb ramp, they shall be mechanically joined prior to installation.

Method of Measurement. Detectable warnings will be measured for payment in place and the area computed in square feet.

Basis of Payment. This work will be paid for at the contract unit price per square foot for DETECTABLE WARNINGS.

PAY ITEM #25 – SIDEWALK REMOVAL

Description. This work shall consist of removing sidewalk. This work shall be in accordance with Section 440 of the Standard Specifications, except as modified herein:

Add the following to Section 440.07 (b):

Sidewalk removal shall include excavation and removal of aggregate base. Sidewalk removal shall also include the removal of any railings that are contained within the concrete sidewalk section.

Contractor shall remove sidewalk to next existing joint beyond the location specified on the plans.

Method of Measurement. This work will be measured for payment in accordance with Section 440 of the Standard Specifications with the following revisions.

Basis of Payment. This work will be paid for at the contract unit price per square foot for SIDEWALK REMOVAL.

PAY ITEM #35 – ADJUSTING WATER MAIN 6”

Description. Remove a section of existing water main that conflicts with the proposed storm sewer and drainage structures and install a new plastic pipe water main adjusted as necessary to enable installation of the proposed storm sewer and drainage structures and to satisfy the horizontal separation requirements of Section 41-2.01A and vertical separation requirements of Section 41-2.01B of the “Standard Specifications for Water and Sewer Construction in Illinois, 7th Edition”.

Material shall be Plastic Pipe in accordance with Section 40-2.01C of the Standard Specifications for Water and Sewer Construction in Illinois, 7th Edition.

This work includes furnishing and installing water main, fittings, restraint devices, connection couplings, casing pipe, casing spacers, and casing end seals, thrust blocks, and backfill material as indicated on the Water Main Details included in the plans and as necessary to connect the realigned water main to the existing water main. The shutdown of existing water main shall include any necessary valve operation to be coordinated with Village or any water main line stops and connections to existing water mains necessary to perform the work. Contractors must not operate valves or hydrants owned by the Village. Contact the Village Water Department foreman for Water Department personnel to operate any valves. Contractor must restrain pipe where necessary to make connection including adding any thrust blocks if necessary.

All work shall otherwise conform to sections 561 of the Standard Specifications and with the “Standard Specifications for Water and Sewer Construction in Illinois”.

Basis of Payment. This work shall be paid for at the contract unit price per foot for ADJUSTING WATER MAIN, 6”, which price shall include shut-down of existing water main, excavation, sheeting and shoring, removal of existing water main, installation of all necessary items and materials, placement of compacted backfill, pressure testing, disposal of surplus excavated materials and removed water main, and disinfection and flushing of the shutdown section of the existing water main system. Trench Backfill shall be included in the cost of this item.

PAY ITEM #44 – COMBINATION CONCRETE CURB AND GUTTER, TYPE B-6.12

Description. This work shall consist of constructing combination concrete curb and gutter as shown on the plans or as directed by the Engineer. This work shall be in accordance with Section 606 of the Standard Specifications, except as modified herein.

Excavation will not be paid for separately but shall be included in the cost of this item.

Combination concrete curb and gutter shall be constructed on a prepared base of mechanically compacted crushed aggregate of CA-6 gradation having a minimum

compacted thickness of 4 in. The prepared base will not be paid for separately, but shall be included in the cost of COMBINATION CONCRETE CURB AND GUTTER, TYPE B-6.12.

Wood forms shall be used. Forms constructed of steel or Masonite will not be permitted. Forms for radius sections of the combination concrete curb and gutter shall be constructed of 1 in. thick wood boards.

The height of the curb head may vary as shown on the plans or as directed by the Engineer. Variations in the height of the curb head will not be paid for separately but shall be included in the cost of this item.

Where combination concrete curb and gutter is constructed across driveways, alleys, sidewalk curb ramps, or other designated areas, the top of the curb shall be depressed according to the details shown on the plans or as directed by the Engineer. The transition from full height curb to depressed curb shall be made over a distance equal to at least four times the difference in height between the full height curb and the depressed curb.

Where combination concrete curb and gutter is constructed across sidewalk curb ramps, the depressed curb shall be in compliance with all applicable requirements of the Americans with Disabilities Act (ADA) and the Proposed Guidelines for Accessible Rights-of-Way (PROWAG).

Expansion joints shall be constructed at 60 ft. maximum centers. Expansion joints shall also be constructed at all construction joints, all points of curvature, all points of tangency, within 5 ft. on either side of all curb structure castings, and at additional locations as directed by the Engineer. Expansion joints shall consist of a 1 in. thick preformed bituminous expansion joint filler that extends the full cross section of the combination concrete curb and gutter. Expansion joint filler material that is larger than the cross section of the combination concrete curb and gutter shall be cut to the exact cross section of the combination concrete curb and gutter. Expansion joints shall have two 18 in. long, No. 6 non-deformed epoxy-coated steel dowel bars placed at mid-depth. The dowel bars shall have a greased plastic expansion cap placed on one end of each dowel bar a minimum of 1 in. from the end of the dowel bar.

Where proposed combination concrete curb and gutter is to be constructed abutting existing combination concrete curb and gutter, the dowel bars shall be drilled into the existing combination concrete curb and gutter. This work will not be paid for separately but shall be included in the cost of this item.

Contraction joints shall be constructed at 15 ft. maximum centers. Where the location of a contraction joint coincides with the location of an expansion joint, the contraction joint may be omitted at the discretion of the Engineer. Contraction joints shall be tooled and sawed. Sawing of contraction joints shall commence as soon as the concrete has

hardened sufficiently to permit sawing without excessive raveling, but in no case shall sawing commence less than 4 hours or more than 24 hours after the concrete is placed. Sawing of contraction joints shall be to a depth equal to 1/3 the thickness of the gutter flag and to a width of not less than 1/8 in. Contraction joints shall be sealed according to Article 420.12, except that joints shall be sealed with polysulfide or polyurethane joint sealant.

If Contractor fails to construct joints in accordance with the requirements of this provision and the curb cracks, the Contractor shall remove and replace the affected section of combination concrete curb and gutter extending the full length between the two adjacent joints on either side of the crack. This work will not be paid for but shall be at the Contractor's expense.

Upon removal of the forms from the back of the combination concrete curb and gutter, excavated areas behind the combination concrete curb and gutter shall be immediately backfilled. Areas where pavement or sidewalks are to be constructed shall be backfilled with crushed aggregate of CA-6 or CA-7 gradation and mechanically compacted. Areas where topsoil and sodding are to be placed shall be backfilled with non-organic material acceptable to the Engineer. This work will not be paid for separately but will be included in the cost of this item.

Basis of Payment. This work will be paid for at the contract unit price per foot for COMBINATION CONCRETE CURB AND GUTTER, TYPE B-6.12, which price shall include all materials, labor and equipment necessary to complete the work as described herein.

PAY ITEMS #45, 46, 47 – CHAIN LINK FENCE

Description. This work shall consist of furnishing and installing black (or other color as approved by OWNER) chain link fence at the baseball field. This work shall be in accordance with Section 664 of the Standard Specifications, except as modified herein:

The fence shall be black powder coated unless a separate color is specified by the owner.

For the three specified fence heights, the following post, rail and fabric information shall be as follows.

Description	8-FT FENCE	OUTFIELD	FOUL LINE
HEIGHT	8 FT	6 FT	4 FT
FABRIC (HEIGHT, GAUGE AND MESH)	8 FT 9 GAUGE CORE 2 INCH MESH	6 FT 9 GAUGE CORE 2 INCH MESH	4 FT 9 GAUGE CORE 2 INCH MESH
TERMINAL POSTS	2 7/8 INCH	2 7/8 INCH	2 7/8 INCH
LINE POSTS	2 3/8 INCH (10 FT O.C.)	2 3/8 INCH (10 FT O.C.)	2 3/8 INCH (10 FT O.C.)
TOP RAIL	YES	YES	YES
MIDDLE RAIL	YES	NO	NO
BOTTOM RAIL	YES	YES	YES
YELLOW TOP CAP	NO	YES	YES

Method of Measurement. Chain link fence will be measured for payment in feet, along the top of the fence from center to center of end posts, excluding length occupied by gates.

Basis of Payment. This work will be paid for at the contract unit price per foot for CHAIN LINK FENCE, of the height specified.

PAY ITEMS #48 AND 49 – CHAIN LINK GATES

Description. This work shall consist of furnishing and installing black (or other color as approved by OWNER) chain link gats in the fences installed surrounding the baseball field. This work shall be in accordance with Section 664 of the Standard Specifications, except as modified herein:

This materials for this item shall include all required materials for the gate including: chain link fabric, gate posts, tension wire, horizontal braces, truss rods, gate frames, post tops, stretcher bars, fabric ties, fittings, bolts and nuts, and Portland cement concrete. This item shall also include latches that will allow for the gate to be locked with a standard padlock.

Method of Measurement. Chain link gates will be measured for payment as each individual gate and the unit of measurement will be each.

Basis of Payment. This work will be paid for at the contract unit price per each for CHAIN LINK GATES, of the opening sizes and types specified.

PAY ITEM #55 – ELECTRIC SERVICE INSTALLATION

Description. This item shall consist of all material and labor required to extend, connect or modify the electric service, and coordination, as indicated or specified, which is over

and above the work performed by the utility. This item may require work to more than one location and will not be paid separately.

Materials. Materials shall be in accordance with the Standard Specifications.

Construction Requirements. The Contractor shall ascertain the work being provided by the electric utility and shall provide all additional material and work not included by other contract pay items required to complete the electric service work in complete compliance with the requirements of the utility.

No additional compensation will be allowed for work required for the electric service, even though not explicitly shown on the Drawings or specified herein

Method of Measurement. This work will be measured for payment in place for each electric service installed.

Basis of Payment. This work will be paid for at the contract unit price each for ELECTRIC SERVICE INSTALLATION which shall be payment in full for the work specified herein.

PAY ITEM #60 – REMOVAL OF PEDESTRIAN LIGHT FIXTURE, SALVAGE

Description. This item shall consist of disconnecting and removing an existing Sternberg Model #1230HPSPT fixture from an existing 12' pole and transporting the fixture to the Village.

Basis of Payment. This work will be paid for at the contract unit price per each for REMOVAL OF PEDESTRIAN LIGHT FIXTURE, SALVAGE which shall include all labor, transportation, materials, and equipment to complete the removal and salvage as described herein.

PAY ITEM #61 – REMOVAL OF LIGHTING UNIT, SALVAGE

Description. This work shall consist of disconnecting and removing a complete existing street light assembly and foundation. This work shall be in accordance with Section 842 of the Standard Specifications, except as modified herein:

The lighting unit shall be returned to Willowbrook High School. The Contractor shall contact the Willowbrook High School building operations manager 14 days in advance of delivery to coordinate time and location of delivery.

Basis of Payment. This work will be paid for at the contract unit price per each for REMOVAL OF LIGHTING UNIT, SALVAGE which shall include all labor, transportation, materials, and equipment to complete the removal and salvage as described herein.

PAY ITEM #68 – IRRIGATION SYSTEM SPECIAL

Description. This work shall consist of furnishing and installing an irrigation system as shown on the contract drawings and specified herein. This work shall include all design, labor, associated materials (whether specified or not), equipment, and supervision required to construct a complete functioning, automatic controlled irrigation system including, but not limited to: watermain connections, backflow preventers, backflow and controller enclosures, valves (mechanical and electric), field wiring, piping (subsurface and pressure), sprinkler heads (rotary and spray, including quick coupling valves), and irrigation controllers.

Scope of Work

Immediately upon notice to proceed, the Contractor shall prepare irrigation shop drawings for the entire irrigation system. The shop drawings shall include the manufacturer and model number of all materials and identify all connections to the irrigation mains and electrical junction boxes. The shop drawings shall also include the designers CID certification number and seal. Catalog cuts for all materials shall accompany the shop drawings.

The Contractor shall confirm that the design presented in the contract drawings provide adequate coverage of all irrigated areas shown and shall identify, in the shop drawings, the need to add heads, reconfigure the layout, and extend any irrigation main or electrical lines to the controllers. The Contractor shall also confirm that all pipe sizes are adequate for the anticipated flows for each of the zones. No additional compensation will be provided for additional heads, valves, piping or other necessary equipment that is necessary to provide adequate coverage of all areas.

The Contractor shall make a recommendation for a watering schedule for this specific project. The recommended watering schedule shall be submitted to the Owner in writing for review and comment. The watering schedule, as modified by the Owners, shall be inputted into the irrigation controller prior to the punchlist walk through.

Any removals (i.e. pavement, curb and gutter, sidewalk, aggregate shoulder, etc.) associated with the installation of the 2-inch water line will not be paid for separately. Removals shall be performed per IDOT Standard Specifications.

Submittals and Substitutions

Irrigation systems shall be installed with Hunter or Rainbird components as identified in the subsequent sections or approved equal equipment, including sprinkler heads, controllers, subsurface irrigation and valves.

Submittal for substitutions shall be documented with the bid and shall include substituted product's detailed specifications and locations for all substituted equipment. Any bid which contains products that do not meet the specification of the equipment specified herein shall be rejected at the Owner's option.

Cut sheets shall be submitted for all specified products. Materials, equipment, and methods of installation shall comply with, at a minimum, the following codes and standards:

- All local and state laws and ordinances, and with all the established codes applicable thereto
- National Electrical Code
- American Society for Testing and Materials (ASTM)
- National Sanitation Foundation (NSF)

Examination of Site

The Contractor acknowledges that he has examined the site, and the submission of his bid shall be considered evidence that examination and acceptance of plan, details and specification has been made.

The Contractor shall provide and pay for all transportation required to deliver and remove from the site all materials and equipment, as required for all the work shown and specified.

Conduct of Work

The Contractor shall maintain a skilled foreman on the site during the entire installation of his work. The foreman shall have the authority to act for all matters pertaining to the work. The Contractor shall be responsible for coordination of his work with the other trades. The Contractor shall confine his operations to the areas to be improved and to the areas allotted him for materials and storage.

Deliveries, Handling and Storage

Materials shall be delivered to the site in accordance with manufacturer's recommendations for shipment and protection of materials. Handling of materials shall be as recommended by manufacturer. The storage of all materials shall be in locations designated and approved by Owner.

The Contractor shall be responsible for securing all material stored on site. The Owner shall not be responsible for the theft of any materials or equipment until said materials and/or equipment have been accepted and turned over to the Owner for their operation and maintenance.

Contractors Responsibility

The Contractor shall be responsible for his work, to include his subcontractors and every part thereof and for all materials, tools, and property of every description used in connection therewith.

The Contractor shall protect the Owner against all liabilities, claims, or demands for injuries or damages to any person or property growing out of the performance of the work under this contract.

Contractor Qualifications

Contractor's qualifications: Minimum 3 years of experience installing irrigation systems of comparable size and scope. References and Client contact information for a minimum of 3 similar projects completed within the last 5 years. The Contractor shall be listed as a "Certified Irrigation Contractor" (CIC) and "Certified Irrigation Design" (CID) by the Irrigation Association (www.irrigation.org). No contract shall be issued without documented verification of qualification requirement. The Contractor shall provide a copy of their CIC and CID certificate with the bid.

Codes, Inspections, Licenses and Permits

The entire installation shall fully comply with all local and state laws and ordinances and with all the established codes applicable thereto including Owner.

The Contractor shall take out all required permits, arrange for all necessary inspections and shall pay any fees and expenses in conjunction with the same as a part of the work under this Section. Village of Villa Park tap on fees and inspection fees will be waived.

Site Conditions

Take precautions to insure that equipment and vehicles do not disturb or damage existing site grading, walks, curbs, pavements, utilities, plants, and other existing items

and elements on public and private property. Repair damage caused by Contractor's negligence at no cost to the Owner. It is the Contractor's responsibility to document the existing conditions with photographs.

Existing Utilities:

- Verify locations and depths of all underground utilities prior to commencing excavation. The Contractor shall contact JULIE for the location of all utilities on public rights-of-way and shall contact the Owners representative for this project to arrange for the location of all onsite utilities.
- Locate existing non-private underground utilities in areas of work. If utilities are to remain in place, provide adequate means of support and protection during this work.
- Private utilities shall be located by Owner at the Owner's expense prior to commencement of work.
- Public and/or private underground utilities that are unknown and not located that are damaged during the course of excavation processes shall be repaired at the Owners expense.
- Should unmarked or incorrectly marked utilities be encountered during excavation, contact Owner and utility owner immediately for direction.
- Cooperate with Owner and utility companies in keeping respective services and facilities in full operation at all times.
- Do not interrupt existing utilities serving facilities occupied and used by Owner or others during occupied hours, except when permitted in writing by Owner and, then, only after acceptable temporary utility services have been provided.
- Provide minimum of 48-hour notice to Owner and Owner's Representative and receive written notice to proceed before interrupting any utility.

Underground Structures:

- Underground structures that are encountered during excavation that are in conflict with the proposed work shown on the plan shall be avoided if possible by adjustment of the depth or alignment of the proposed work.
- The proposed work shall still meet the requirements for minimum depth and any changes in the alignment shall be documented on the record drawings.

- If alignment and depth adjustment cannot be made and it becomes necessary to remove the obstruction or structure in conflict, the Contractor shall be paid for additional cost incurred for removal of the conflicting structure. All additional work for which the Contractor is seeking additional compensation must be documents in writing and approved in advance.

Protection of Persons and Property:

- Barricade open excavations occurring as part of this work and post warning lights.
- Operate warning lights as recommended by authorities having jurisdiction.
- Protect structures, utilities, sidewalks, pavements, curbs, and other facilities from damage caused by settlement, lateral movement, undermining, washout, and other hazards created by this work. Any damage to existing facilities shown to remain shall be repaired or replaced at the Owner's option, at the expense of the Contractor.

Post Construction Documentation

After completion of the irrigation system installation, the Contractor shall furnish to the Owner, three sets of "Drawings of Record" on 24" x 36" paper. The Contractor shall also furnish the drawings electronically in AutoCAD format on a CD-ROM. Both electronic and hard copies of the "Drawings of Record" shall be submitted to the Village for approval within 30 days of substantial completion.

Record drawings shall be provided, reviewed and approved prior to the punchlist walk through so that accuracy can be confirmed during the walk through.

The record drawings shall include the following at a minimum:

- Dimensions from two fixed points for all main line isolation valves, zone valves, and wire splice boxes will be required on the "Drawings of Record"
- Mainline and Lateral Pipes and their types and sizes
- Control valve locations, sizes, zone numbers and areas of coverage
- Manual shut off valves and their sizes
- Sprinkler heads (with sizes and manufactures model number)
- Quick couplers (with sizes)

- Valve boxes (with sizes and type)
- Sleeves (with pipe type and sizes)
- Sprinklers, controller, rain shut off device, filter, and back flow prevention equipment (if necessary)
- Points of connection including type of water sources, size, flow rates, and operating pressure range
- Electrical Connection and details
- Control wire locations, splice locations, splice box locations and connection details
- Dates and scale
- Contractor's name, address and telephone number
- Contractor's license number (where applicable)
- Designer's names, address, and telephone number
- Designer's professional registration number (where applicable)
- Provide the manufacturers' recommended operating instructions for all major components incorporated into the irrigation system
- Provide system operation manuals, maintenance schedules, and recommended schedule of operation including average application rates, with seasonal adjustments for each zone
- Provide all required testing and inspection certificates to the Owner

Guarantee

The Contractor shall assume full responsibility for the proper installation of the system and shall make all necessary, reasonable efforts to handle any warranty claims in a reasonable time period.

For a period of one (1) year from the date of final acceptance of work performed under this section, the Contractor shall promptly furnish and install any and all parts and equipment, which prove defective in material, workmanship, or installation at no additional cost to Owner.

During construction and the one (1) year guarantee period, the Contractor shall drain and winterize the irrigation system(s) each fall for the winter and shall put the irrigation system(s) back into operation each spring at no additional cost to Owner.

Materials.

Connection to Existing Watermain 2"

- Corporation Stops – Mueller H1500, 1-inch minimum, AWWA C800
- Service Pipe – Copper tube, 2-inch and smaller, ASTM B88, Type K (1" minimum) and ductile Iron, larger than 2-inch
- Curb Stop – Copper service, Mueller H-15154 as denoted in the irrigation detail sheet
- Curb Box – Copper service, Mueller H-10302 or H-10304 as denoted in the irrigation detail sheet.

All taps shall be made under pressure unless otherwise approved by the Village. Connection to the existing water mains shall be performed using a direct tap. No saddles will be allowed.

Meter

The meter shall be installed in the backflow preventer enclosure and shall include a meter spread for a 2" meter.

Meter to be provided and installed by the Contractor.

Booster Pump

- The booster pump shall be a Berkeley BPD series pump or approved equal.
- The pump shall be a minimum of 1 H.P. and capable of providing the necessary pressure required to adequately pressurize the proposed irrigation system at a flow of 50 GPM.
- Adequate pressure shall be a minimum of 40 psi at the furthest head from the pump under normal irrigation operations.
- Pump shall have a steel or fiberglass reinforced thermoplastic body and base
- The pump drive shaft shall be 416 stainless steel.

- The pump shall include all necessary hardware, wiring, pipe connections and valving for installing in accordance with the manufacturers recommendation.
- The pump shall be installed with valves and electrical and plumbing disconnects to allow its quick and easy removal each fall.
- A shop drawing of the pump installation shall be provided to the Owner for review and approval prior to installation.

Backflow Preventer, 2"

The backflow preventers shall be provided at all points of connection to the potable watermain.

The backflow preventer shall be installed in accordance with all of the requirements of the Standard Specifications for Water and Sewer Construction in Illinois and the Village of Villa Park.

The backflow preventer shall be 2" in size (unless otherwise noted) Reduced Pressure Zone (RPZ) type backflow preventer and shall meet the following requirements.

The backflow preventer shall be manufactured by Watts (series 909) or Febco.

Standards Compliance:

- ASSE® Listed 1013
- AWWA Compliant C511
- Approved by the Foundation for Cross-Connection
- Lead Plumbing Law Compliance
- 0.25% Max Weighted Average Lead Content
- Certified by IAPMO R&T Lab
- Max. working water pressure 175 PSI (1200 kPa)
- Max. working water temperature 180°F (82°C)
- Hydrostatic Test Pressure 350 PSI (2400 kPa)
- Valve Body Unleaded Bronze (Federalloy I-836)

- Access Cover Unleaded Bronze (Federalloy I-836)
- Polymers NorylTM, NSF Listed
- Elastomers Silicone
- Springs Stainless Steel
- Shall include union end ball valves

Reduced Pressure Principle backflow preventer shall protect against backflow by either backpressure or back siphonage from a cross-connection between potable water systems and substances that are non-health and health hazards.

The device shall be ANSI 3rd party certified to comply with states lead plumbing law and shall be constructed from unleaded bronze with less than 0.05% lead content (Federalloy I-836 or approved equal). It shall consist of two (2) mechanically independent, spring loaded, center stem guided check valves. It shall also have a hydraulically dependent differential pressure relief valve with the sensing passage set in an integral cast unleaded bronze body, with a single access cover. The assembly shall have four (4) vertical test cocks and two shut off valves which are quarter-turn, full-port, resilient seated and ball type which are constructed with low lead material, less than 0.25% lead content (ASTM C90500) or approved equal.

The relief valve shall have removable stainless steel seat ring. The check valves shall be held into place by stainless steel clips and the check valve assemblies shall be non-interchangeable with silicone discs.

Backflow Preventer Enclosure

The backflow preventer enclosure shall be a fiberglass of composite material and shall be sized for the proposed meter and backflow preventer. The enclosure shall be installed on a concrete or precast concrete composite pad sized for the enclosure.

The enclosure shall be LokBox LB2S or approved equal.

Sprinkler Heads – Rotor Type (Hunter I-20-04-SS and I-40-04-SS)

The full or part circle sprinklers shall be a gear-driven rotary type. Part-circle models shall be adjustable. The sprinkler shall have interchangeable nozzles with a radius adjustment screw.

The body and cap of the sprinkler shall be molded of a non-corrosive, impact-resistant, UV-resistant, heavy-duty plastic material. The sprinkler shall have a plastic filter screen

sized to prevent entry of foreign material to the nozzle. All components shall be removable from the top of the sprinkler case.

The sprinkler shall have a single-piece stainless steel riser/body seal that regulates flushing during pop-up and retraction to clear any debris from around the riser, and a heavy-duty stainless steel spring to ensure positive retraction.

The sprinkler shall be capable of accepting any one of 24 nozzles. The nozzles shall be available in short and standard trajectories.

All sprinkler head shall have a rubber top.

Quick Coupling Valves

Quick Coupling Valves shall be Rainbird 1" Quick Coupler Model 5LRC (or approved equal). Install quick coupling valve as per detail on the Contract Drawings. Provide (2) matching quick coupler keys with hose swivels.

Automatic Control Valves

Automatic control valves shall be Hunter ICV Filter Sentry series (or approved equal) of the size specified in the plans.

- Solenoid control valves shall be completely serviceable while installed in line or shall have a union connection on the downstream side; shall have body and bonnet constructed of heavy-duty glass-filled nylon, a flow control device; shall operate on approximately 24 volts, be normally closed, and be slow-closing globe type.
- Pressure reduction riser in-line spring check valve, if any, shall have a body constructed of type 1 PVC. The valve stem shall be 18-8 stainless steel with BUNA-N poppet seal. The 1/2-pound spring shall be 18-8 stainless steel. The valve shall have male x female threads, 3/4 inch NPT.
- Valves used in the electrically controlled automatic system shall be a globe / angle configuration.
- All valves shall have, and external and internal bleed to manually turn them on.
- Valves 1 1/2" and larger shall have a manual flow control.
- Valves size and location – refer to plan.
- All automatic control valves shall be marked with the corresponding zone number with a stamped brass disc permanently affixed to the valve body.

Controller

Automatic Controller shall be Hunter ACC 1200 with gray metal cabinet or approved equal. At a minimum, Controller shall have a 365 minimum day calendar, 0 – 10 hour station run times, seasonal adjust from 0% - 200%.

Controller to have a rain/weather sensor port built into the unit.

Power supply to hard wired Irrigation Controllers to be performed by Contractor.

The irrigation controller shall be mounted on a pedestal adjacent to the house for the backflow preventer as shown on the plans. The Contractor shall provide detailed shop drawings for the electrical connections between the electrical service box and the pedestal.

Wire and Fittings

When selecting the wire take into consideration the length of wire run, static water pressure, the primary input voltage to the controller and the number of valves on the system that will run simultaneously.

All field wiring (electrical control wires) shall be type PE copper for operation of 600 maximum voltage. Consult with the owner regarding the use of single or multi stranded wire and wire gauge.

Make field wire connections with King waterproof wire nuts (or approved equal) and provide expansion turns at every 200-foot with 6 feet of slack at each electric valve. (All wiring shall be installed in accordance with local and national electrical codes requirements and Installed as per manufacturer's recommendation.)

All wire connections shall be made using UL approved connectors.

All field control wire shall be UL approved direct bury wire.

Any multiple valves operating on one zone shall have its own signal wire from the controller.

Any future wires stubbed from initial installation must run from controller to approximate location (show on plan) and installed in a valve box.

Future wires shall be a different color from initial installation. Ten feet of slack wire shall left at controller box location.

No splices of the wire will be allowed between valves or the controller. In the event that a splice is required or at the direction/approval of the owner, the splice shall be made in a valve box per 2.16 below.

There shall be a minimum of 6 spare wires in each cable used to connect the controller to the automatic control valves. These wires shall be marked at each end with waterproof marking tape as spares.

PVC Piping

All PVC Piping shall be sized as shown on drawings.

All 2" and larger pipe shall be virgin, high impact, polyvinyl chloride (PVC) pipe. And rated for 175 PSI for continuous service as 73 degree F and meet SDR 21 dimensions ratio for wall thickness.

Pipe shall conform to A.S.T.M. (American Society for Testing and Materials) standards D2241 & D2672 or latest revision.

Materials shall conform to all requirements of A.S.T.M., D1784, or latest revision.

All PVC pipe shall be furnished in 20'-0" lengths. All lateral line pipe shall have one end belled for solvent weld connection.

All PVC pipe shall be continuously and permanently marked with manufacturer's name, material, size, and schedule or type.

A two-step gluing process must be used.

All PVC mainline piping shall include the installation of a trace wire. The trace wire shall be connected and exposed within each valve box to allow for the location of all mainline piping from the valves back to the sources.

PVC Pipe Fittings

All pipe fittings shall be Schedule 40, and constructed for solvent weld attachment to PVC pipe.

All Schedule 40 fittings shall be full sized. Any required reduction of pipe size shall be accomplished with slip by slip or slip by female pipe thread reducer bushings. Molded reducing type fittings will not be accepted.

Conform to ASTM D-1784, ASTM D-2466.

A two-step gluing process shall be used.

Polyethylene Pipe

All pipe 1-1/2" and smaller pipe shall be flexible non-toxic polyethylene pipe made from 100% virgin material meeting N.S.F. (National Sanitation Foundation) standard #14 for use in pressure potable water applications, for 800 design stress.

All sizes shall have a minimum 100 P.S.I. working pressure rating. All polyethylene pipe shall be continuously and permanently marked with the manufacturer's name, material, size, and schedule. Pipe shall conform to A.S.T.M., D2239, and D1248 (3C5PE34) or latest revision.

All polyethylene pipe shall be furnished in minimum 100-foot rolls.

The polyethylene pipe shall be as manufactured by Cresline, Eagle Plastics or approved equal.

Polyethylene Fittings

All polyethylene fittings shall be the plastic insert type and used in conjunction with crimp type stainless steel clamps. Combination FPT insert tees or insert ells shall be used to connect the sprinkler heads to the polyethylene pipe.

The insert fittings shall be as manufactured by Cresline, Spears or an approved equal.

The clamps shall be as manufactured by Otiker or an approved equal.

The tapping saddles shall be as manufactured by Kwikseal or an approved equal.

Sleeves

Sleeves for all irrigation piping and control wires shall be provided beneath all pavement and walks and shall be two times the diameter of the pipe to be inserted or as shown on the plans. Sleeve pipe material shall be a minimum of Schedule 80 PVC if the pipe is to be installed by open cut or directional bore and shall be galvanized steel if to be installed by pushing or ramming.

The Contractor shall be responsible for providing sleeves for all irrigation crossings regardless of whether or not they are shown on the plans. If additional sleeves are required, they shall be installed at no cost to the owner and shall be shown on the shop drawings.

The ends of all sleeves shall be permanently marked on the pavements above each sleeve. An "I" shall be chiseled or sawed into the pavement above each end of the sleeve.

Swing Joints

Rotary Sprinkler head and Quick Couplers (and any head with a 1" or larger connection) - Swing joints shall be utilized to connect all rotary sprinkler heads and quick couplers to the lateral piping. Swing joints shall be PVC double O-ring swing joint, Schedule 80 wall thickness as manufactured by the Spears Company SJ-2A-0701 or an approved equal. Swing Joint Riser Assemblies carry a rated working pressure of 315 psi at 73°F and are pressure tested to Schedule 80 specifications per ASTM D1599, long term (1000 hours) and pressure tested to Class 315 specifications per ASTM D1598. Swing Joint Riser Assemblies shall have a Five (5) Year Standard Product Warranty

Rotary Sprinkler head and Quick Couplers (and any head with a ¾" connection) - Swing joints shall be utilized to connect all rotary sprinkler heads to the lateral piping. Swing joints shall be PVC double O-ring swing joint, Schedule 80 wall thickness as manufactured by Rainbird (TSJ-12075) or an approved equal. Swing Joint Riser Assemblies carry a rated working pressure of 315 psi at 73°F and are pressure tested to Schedule 80 specifications per ASTM D1599, long term (1000 hours) and pressure tested to Class 315 specifications per ASTM D1598. Swing Joint Riser Assemblies shall have a Five (5) Year Standard Product Warranty

Spray Heads (and any head with a 1/2" or smaller connection) – Flexible Swing joints shall be utilized to connect all spray sprinkler heads to the lateral piping. Flexible swing joints shall be manufactured by Dura Plastic Products (FSM-005) or approved equal. Swing joint must have a 315 p.s.i. working pressure rating under ASTM 3139 Standard. Assembly shall be protected by a 4-Year Performance Warranty.

The swing joint shall allow stable positioning of the sprinkler to grade during installation and allow flexibility in three dimensions to reposition the sprinkler head.

The connections shall be any combination of a tapered 1/2", 3/4" or 1" Male National Pipe Thread, as specified.

Manual Valves

All Isolation Valves shall be AWWA approved iron body resilient seal wedge disc, non-rising stem with a square operating nut and flanged hubs sized for IPS PVS pipe.

All Isolation Valves shall be as manufactured by American Flow Control, Waterous or an approved equal. The Contractor shall provide the Owner with two isolation valve operating keys.

Any necessary ductile iron fittings shall be as manufactured by Harrington Corporation or approved equal.

Manual shut off valves shall be located as indicated in this section and the valve box details.

Valve and Control Access Boxes

Control valve boxes shall be located in 10-inch diameter valve pits or 16x10-3/4x12 inch rectangular boxes for individual valves. Multiple valves shall be placed in larger rectangular boxes as appropriate.

Quick coupler valve boxes shall be located in 10-inch diameter round valve pits.

Individual manual valves shall be located in 10-inch diameter round valve pits or 16x10-3/4x12 inch (12" x 18" nominal) rectangular boxes for individual valves.

All valve boxes shall be Pentek Irrigation Turf Boxes or an approved equal. The box and cover color shall be green.

Trace Materials

Trace materials is require for all irrigation piping including laterals.

- Trace wire shall be buried directly with the proposed irrigation pipe.
- Trace wire for irrigation pipes shall be installed with 2' feet of slack in each valve box. All trace wires shall be joined with a wire nut and a single pigtail No. 14 wire shall be provided for signal hook up.
- Metallic core trace tape for lateral lines shall be installed with 2' of slack in each valve box and shall be tied together in a manner that will allow a signal lead to be attached to one location such that all terminated tape received the signal.
- Plastic trace tape shall be installed with 2' of slack in each valve box and shall be tied together.
- All trace materials shall be neatly organized within each valve box so that maintenance access to valves is not impeded.
- Trace materials shall meet the requirements of Section 31 2316 except as modified below. The following irrigation pipes will be installed with the listed trace materials:
 - 4" dia. and greater mainline pipes - No. 6 insulated copper wire AND plastic trench tape at 12" below grade.

- Less than 4" dia. mainline pipes - No. 14 insulated copper wire AND plastic trench tape at 12" below grade.
- Lateral pipes - EITHER No. 14 insulated copper wire OR metallic core trace tape.

Trace wire insulation and all trace tapes shall be purple in color. Trace tape shall be imprinted with the words "irrigation" or "reclaimed water" in text along the length of the tape.

Main line pipes are those pipes between the water source and the automated irrigation valves. Lateral pipe are those pipes that are located between the automated irrigation valves and the irrigation heads.

Construction. Irrigation system layout shown on the Contract Drawings is diagrammatic. The Contractor shall establish exact locations in the field of piping, sprinkler heads, subsurface irrigation, valves, and other components at time of installation and on the approved shop drawings. The sprinkler components shall be spaced as indicated and as per manufacturer recommendations. Minor adjustments to the system layout will be permitted to clear existing fixed obstructions. The final system layout shall be acceptable to the Owner based on the approved shop drawings.

All work related to the connection to the existing main and backflow preventer shall be performed in accordance with the Standard Specifications for the Construction of Water and Sewer Mains in Illinois and the Village of Villa Park. All irrigation work shall be performed in accordance with the manufacturer's recommendations and the requirements of the Village of Villa Park.

Excavation and Backfilling

Excavation shall include all materials encountered, except materials that cannot be excavated by normal mechanical means.

- Excavated trenches shall be of sufficient depth and width to permit proper handling and installation of pipe, wire and fittings.
- If the pulling method is used (except subsurface and drip), the pipe "plow" shall be a vibratory type.
- Excavate to depths required to provide 2" depth of earth fill or sand bedding for piping when rock or other unsuitable bearing material is encountered.
- Fill to match adjacent grade elevations with approved earth fill material. Place and compact fill in layers not greater than 6" depth immediately after the backfill has been placed. Care shall be taken not to disturb the pipe or its foundation.

- Provide approved earth fill or sand to a point 4" above the top of pipe.
- Overfill with approved excavated or borrow fill materials free of lumps or rocks larger than 3" in any dimension. Level, compact, and water settle. Should settlement occur, refill and re-seed as required at no additional cost to the Owner.
- Install irrigation mains at the required depth.
- Excavate trenches and install piping and fill during the same working day. Do not leave open trenches or partially filled trenches open overnight.
- A trace wire shall be included with the installation of all PVC main line piping. The trace wire shall be continuous and without splice in all trenches. Any splicing shall be performed in valve boxes. Trace wire shall be visible and accessible in all valve boxes for the mainline piping. Trace wire shall be taped or fastened to the centerline of the pipe at 10 foot centers such that the trace wire is not dislodged from the pipe during backfill operations.
- Installation for the PVC lateral piping shall be either open cut trench or vibratory plow.

Pressure Plastic Pipe

Install plastic pipe in accordance with manufacturer's installation instructions.

- Saw cut square. Remove all burrs and shavings from saw cuts.
- Make plastic-to-plastic joints with a 2 step solvent welded joints or slip seal joints. Use only solvent recommended by the pipe manufacturer. Install plastic pipe fittings in accordance with pipe manufacturer's instructions.
- Allow joints to set at least 24 hours before pulling or pressure is applied to the system.
- All solvent weld joints are to be completed using a high etch PVC primer and a heavy body PVC cement.
- Uncoil poly-pipe and insert fitting full depth. Install fitting and crimp type connectors per manufactures recommendation.
- Maintain pipe interiors free of dirt and debris. Close open ends of pipe by acceptable methods when pipe installation is not in progress and over all non-working hours.

- Piping layout indicated is diagrammatic only. Route piping to avoid plants, ground cover and structures.
- Pipe may be installed by open cut or vibratory plow. All open cut installation shall be restored with trench spoil material similar to that which was excavated.
- It shall be the responsibility of the Contractor to provide adequate protection to compensate for expansion or contraction of the plowed pipe during installation. Plowed pipe should be provided with adequate time to adjust to ground temperature before any connections are made.

Pipe shall be installed to the following minimum depths:

Pipe Size	Depth below finished grade
Control Wire	18"
Irrigation Pipe - 1"	18"
Irrigation Pipe - 2"	18"
Irrigation Pipe - 3"	18"
Irrigation Pipe - 4"	24"
Irrigation Pipe - 6"	30"

Sprinklers, Fittings, Valves and Accessories

Install fittings, valves, sprinkler heads, risers, and accessories in accordance with manufacturer's instructions, except as otherwise indicated.

- All piping, valves, and fittings are to be adequately supported, anchored, braced or strapped to withstand hydraulic thrust. Provide concrete thrust blocks where required at fittings and valves. Special attention shall be paid to ensure that the thrust block mass is sufficient to restrain pipe, valve or fitting movement.

- All horizontal bends on mainlines shall be buttressed with either poured concrete or concrete block as all changes in direction. Concrete buttress dimensions shall be determined in the field by the Contractor.
- It shall be the responsibility of the Contractor to provide adequate protection to compensate for expansion or contraction of the plowed pipe during installation. Plowed pipe should be provided with adequate time to adjust to ground temperature before any connections are made.
- Set sprinkler heads perpendicular to finish grades, except as otherwise indicated or as per manufacturer's recommendations.
- Locate sprinkler equipment as per Shop Drawings. Any deviations from Shop Drawings shall be approved by owner's representative. Do not exceed sprinkler head spacing distances indicated on plan.
- Install quick-coupling valves in minimum 10" valve box and on 3 elbow swing joint assembly as per manufacturer's recommendation.
- Install automated irrigation head in funny pipe connects as specified elsewhere in this specification.
- Install fittings and accessories as shown or required to complete the system.
- Install controller as detailed.
- Waterproof wire conduit to provide a complete, waterproof, permanent, and neat job.
- Ground controller in accordance with manufacturer's recommendations.
- Install in-ground control valves in a valve access box as indicated.
- Install valve access boxes on a suitable base of gravel to provide a level foundation at proper grade and to provide drainage of the access box.
- Seal threaded connections on pressure side of control valves as per manufacturer's recommendations.

Field Wiring

All required electrical work shall conform to the National Electric Code, latest edition.

- Install electric control cable in the piping trenches wherever possible. When not possible, place wire in trench adjacent to pipe. Install wire with slack to allow for thermal expansion and contraction. Expansion joints in wire may be provided at 200-foot intervals. Where necessary to run wire in a separate trench, provide a minimum cover of 18”.
- Provide sufficient slack at site connections at remote control valves in control boxes, and at all wire splices to allow raising the valve bonnet or splice to the surface without disconnecting the wires when repair is required.
- Connect each remote control valve to one station of a controller except as otherwise indicated.
- Connect remote control valves to a common ground wire system independent of all other controllers.
- Make field wire connections to remote control electric valves and splices of wire in the field; using UL listed burial splice connectors in accordance with manufacturer’s recommendations.
- Provide tight joints to prevent leakage of water and corrosion build-up on the joint.

Sleeves

Sleeves are required wherever the proposed irrigation piping or control wire crosses beneath a paved surface. The following requirements shall be followed:

- Pipe and wire crossing under roads, walkways, permanent fixtures, etc. shall be enclosed in sleeves. Sleeve depth shall be a minimum of 24” and a maximum of 32” under items crossed (curbs, roadways, pathways.)
- Sleeve diameter shall be a minimum of two sizes larger than the pipe which is carries.
- All sleeves shall extend beyond the edge of paving or construction by a minimum of 12”.
- The ends of all sleeves shall be marked by cutting, grinding or stamping an “I” into the pavement or curb over each end of the sleeve.

Flushing, Testing, and Adjustment

Prior to punchlist walk through and inspection by the Owner, the Contractor shall perform the following testing.

- After completion of the piping system and prior to backfilling and the installation of the sprinkler heads, the entire system shall be tested for leaks and thoroughly flushed under pressure to remove any dirt, scale, or other material.
- Testing of pipe shall not be done until all joints have had least twenty-four (24) hours to set and cure. During cold weather, forty-eight (48) hours elapsed time shall be allowed for setting prior to testing. Do not conduct any testing when temperatures are at, below or fast approaching freezing point. No water under pressure shall come in contact with any joint during the specified curing period. In hot weather, water shall not be permitted to stand in pipes until after backfilling is completed. Water used in testing shall be drained from pipes after completion of testing.
- Upon system completion, perform system testing. Make necessary repairs and retest-repaired sections as required.
- Adjust sprinklers after installation for proper and adequate distribution of the water over the coverage pattern. Adjust for the proper arc of coverage.
- Tighten nozzles on spray type sprinklers after installation.
- Adjust all electric remote control valve flow control stems and pressure regulating devices for system balance where applicable.
- Test and demonstrate operation of the sprinkler system to the owners representative.
- Fully flush all subsurface piping manually and demonstrate flush valves for proper operation.
- After completion and testing of the system, the Contractor will instruct the Owner's personnel in the proper operation and maintenance of the system to the satisfaction of the Owner.

System Winterization

The irrigation system shall be designed to be winterized by purging the water from the piping system and control valves through the sprinkler heads via the induction of high volume compressed air with a minimum 300 to 450 CFM air compressor.

At a minimum, the first winterization and spring start-up of the newly installed system shall be the responsibility of the Contractor that has installed the system.

The winterization and spring start up requirement shall be utilized to train the Owner's grounds maintenance personnel in the proper procedure of same.

Acceptance

After completion and testing of the system, the Contractor will instruct the Owner's personnel in the proper operation and maintenance of the system to the satisfaction of the Owner's grounds maintenance supervisor.

A final inspection/walk through will consist of the follow key elements:

- Head count and layout
- Valve locations
- Controller location(s)
- System operation
- As built review
- Final product submittals, including owner's manuals, adjustment instructions and performance specifications
- Warranty documentation and contact information
- Written notification, signed by owner's representative and the Contractor, indicating system completion in compliance with drawings, specifications, contracts and industry standards

The Contractor shall instruct the Owner in the operation of the system, including adjustment of sprinklers, controller(s) and valves. Upon (written) acceptance, the Owner will assume operation of the system.

Method of Measurement. This work will be measured for payment on a lump sum basis. No measurement will be made of any of the individual components of this work.

Basis of Payment. This work will be paid for at the contract unit price per lump sum for IRRIGATION SYSTEM SPECIAL which shall include all labor, materials, and equipment to complete the installation as described herein. No payment will be made until the system is completely installed, tested, and signed off by the Engineer and Village.

PAY ITEM #69 – BENCH REMOVAL

Description. This work shall consist of the removal and disposal of the existing players benches and foundations as indicated on the engineering plans. Contractor is responsible for disposal of benches and foundations to an offsite location.

Method of Measurement. This work will be measured for payment as each individual players bench removed and the unit of measurement will be each.

Basis of Payment. Bench removals shall be paid for at the contract unit price bid per each of BENCH REMOVALS.

PAY ITEM #70 – PLAYERS BENCH

Description. This work shall consist of furnishing and installing players benches as indicated on the construction documents.

Materials.

1. Players Benches: Silver aluminum with 2 x 3/8" O.D. tubing supports, equivalent to Kay Park Recreation Product #152G-A, 15' length, in-ground mount.

Installation.Players Benches

1. Comply with manufacturer's written installation instructions, unless more stringent requirements are indicated. Complete field assembly of site furnishings, where required.
2. Unless otherwise indicated, install site furnishings after landscaping and paving have been completed.
3. Install site furnishings level, plumb, true, and positioned at locations indicated on Drawings and approved locations by Owner.

Method of Measurement. This work will be measured for payment as each individual players bench installed and the unit of measurement will be each.

Basis of Payment. Players bench shall be paid for at the contract unit price bid per each of PLAYERS BENCH.

PAY ITEM #71 – PEDESTRIAN TRUSS SUPERSTRUCTURE

Description. This work shall consist of furnishing and installing a 22' long x 6' wide pedestrian bridge.

The bridge superstructure shall be meet IDOT's Guide Bridge Special Provisions 33 – Pedestrian Truss Superstructure.

Bridge abutments shall be paid for under separate standard pay items and shall not be included in the cost of PEDESTRIAN TRUSS SUPERSTRUCTURE.

Basis of Payment. Per IDOT GBSP 33, the pedestrian truss superstructure will be measured in square feet of completed accepted structure measured horizontally from back to back of abutments and within clear path width as defined on the plans.

Basin of Payment. The pedestrian superstructure will be paid for at the contract unit price per square feet for PEDESTRIAN TRUSS SUPERSTRUCTURE.

PAY ITEM #72 – DRAINAGE RESTRICTOR

Description. This work shall consist of furnishing and installing a drainage restrictor as indicated on the construction documents.

Installation. Once the catch basin and pipes have been installed, contractor shall install a 12-inch PVC cap on the end of the pipe. A 2-inch diameter hole shall be drilled into the cap to match the invert elevation shown on the plans.

Method of Measurement. This work will be measured for payment as each individual drainage restrictor installed and the unit of measurement will be each.

Basis of Payment. Drainage restrictor shall be paid for at the contract unit price bid per each of DRAINAGE RESTRICTOR.

PAY ITEM #73 – REMOVE AND REPLACE SIGN AND SUPPORTS

Description. This work shall consist of the removal and reinstallation of the "Willowbrook Park" sign as indicated on the construction documents. This includes the removal of the existing foundations and installation of new foundations as shown on the plans.

Method of Measurement. This work will be measured for payment as each individual sign removed and reinstalled and the unit of measurement will be each.

Basis of Payment. Remove and replace signs and supports shall be paid for at the contract unit price bid per each of REMOVE AND REPLACE SIGN AND SUPPORTS.

PAY ITEM #74 – DRAINAGE WEIR

Description. This work shall consist of constructing a drainage weir as indicated on the construction documents.

Materials.

1. Portland Cement Concrete as described in Article 1020
2. Reinforcement bars as described in Article 1006.10(a)

Installation.

Drainage Weir

1. The weir wall shall be constructed to an elevation within 0.01' of the specified elevation

Method of Measurement. This work will be measured for payment as each individual drainage weir installed and the unit of measurement will be each.

Basis of Payment. Drainage weir shall be paid for at the contract unit price bid per each of DRAINAGE WEIR.

PAY ITEM #75 – EXPLORATION TRENCH, SPECIAL

Description. This work shall consist of constructing a trench for the purpose of locating and inspecting any existing utility or utilities. This work shall be in accordance with Section 213 of the Standard Specifications, except as modified herein.

The exploration trench may be used to locate any existing utility or utilities, including, but not limited to, water mains, water services, sewer mains, sewer services, field tiles, gas lines, underground electric lines, underground telephone lines, underground cable TV lines, underground communication lines, underground fiber optic lines, and other utilities as applicable.

The exploration trench may be used to locate existing utilities regardless of whether the utilities are public or private; known or unknown; or marked or unmarked. The exploration trench may also be used to inspect the condition of existing utilities,

determine the material type or dimensions of existing utilities, and to verify clearances between multiple utilities.

The exploration trench shall be constructed at the locations shown on the plans or as directed by the Engineer. The depth of the exploration trench shall vary as necessary, but shall be sufficient to locate the utility or utilities under investigation. The width of the trench shall be sufficient to allow proper investigation of the entire trench.

Upon completion of the exploration trench, the trench shall be backfilled. All exploration trenches where the inner edge of the trench is within 2 ft of an existing or proposed edge of pavement, driveway, curb, gutter, curb and gutter, stabilized shoulder, or sidewalk shall be backfilled with trench backfill in accordance with Section 208 of the Standard Specifications. Exploration trenches which do not require trench backfill shall be backfilled in accordance with Article 550.07 of the Standard Specifications. Backfilling of exploration trenches will not be measured for payment but shall be included in the cost of this work.

Method of Measurement. The exploration trench will be measured for payment in feet of actual trench constructed, regardless of the depth of the trench constructed. No additional measurement or compensation will be allowed for any delays or unforeseen circumstances arising from this work.

Basis of Payment. This work will be paid for at the contract unit price per foot for EXPLORATION TRENCH, SPECIAL.

PAY ITEM #76 – STORM SEWERS, DUCTILE IRON 30”

Description. This work shall consist of furnishing and the installation of 30-inch ductile iron storm sewer as defined on the plans or as directed by the Engineer. Pipe installation shall be installed and backfilled in accordance with section 550 of the Standard Specifications. The cost of the trench backfill, where applicable, shall be included in the contract unit price bid for this item.

Materials. Pipe shall be Ductile Iron Class 52 – 30” inner diameter.

Method of Measurement. This work will be measured for payment in place in feet.

Basis of Payment. This work will be paid for at the contract unit price per linear foot for STORM SEWERS, DUCTILE IRON 30”.

PAY ITEM #77 – TRAFFIC CONTROL AND PROTECTION (SPECIAL)

Description. This work shall consist of the furnishing, installation, maintenance, relocation, and removal of work zone traffic control and protection. This work shall be in accordance with Section 701 of the Standard Specifications, the Supplemental Specifications, the “Illinois Manual of Uniform Traffic Control Devices”, the Highway Standards and details contained in the Plans and Special Provisions, and the Special Provisions contained herein, except as modified herein.

The bid price for TRAFFIC CONTROL AND PROTECTION (SPECIAL) shall not exceed 5 percent of the total bid price. If the bid price for TRAFFIC CONTROL AND PROTECTION (SPECIAL) exceeds 5 percent of the total bid price, the Village may reject the Bid.

Special Attention is called to Article 107.09 of the Standard Specifications and the following Highway Standards, Details, Recurring Local Roads and Streets Special Provisions, and Special Provisions contained herein, relating to traffic control.

HIGHWAY STANDARDS: 701301, 701311, 701501, 701801, 701901

DETAILS:

Traffic Control and Protection for Side Roads, Intersections, and Driveways
(TC-10)

SPECIAL PROVISIONS (Included in these Special Provisions):

Maintenance of Roadways
Work Zone Traffic Control Surveillance (LRS 3)
Flaggers in Work Zones (LRS 4)
Sidewalk, Corner, or Crosswalk Closure (BDE)

Contractor shall contact the Village at least 72 hours in advance of beginning work. Construction operations shall be conducted in a manner such that streets shall be open to emergency traffic and accessible as required to local traffic. Advanced notice shall be provided to residents, police, fire, school districts, school bus companies, and trash haulers when access to any street will be temporarily closed or limited. Removal and replacement of curb and gutter and driveways shall be planned so as to cause a minimum of inconvenience to the abutting property owners. The work shall be accomplished such that the streets shall be left open to local traffic at the end of each workday.

Method of Measurement. This work will be measured for payment on a lump sum basis. No measurement will be made of any of the individual components of this work.

Basis of Payment. Traffic control and protection will be paid for at the contract lump sum price for TRAFFIC CONTROL AND PROTECTION (SPECIAL), which price shall include all of the above listed requirements, details, standards, and special provisions.

PAY ITEM #78 – PRECONSTRUCTION VIDEO RECORDING

Description. This work shall consist of performing color video and audio recording of the project area and other areas which may be impacted by construction.

Pre-construction video recordings will include coverage of the project area and all other areas which may be impacted by construction. Video recordings will also include construction easements when applicable. Video recordings will provide a visual record of all physical features within those areas, including, but not limited to, roadways, pavements, curbs, gutters, driveways, driveway aprons, sidewalks, carriage walks, parkways, trees, landscaping, shrubbery, plantings, landscaping walls, retaining walls, signs, sign posts, fences, utility poles, light poles, utilities, equipment, manholes, b-boxes, cleanouts, valves, curb structures, pipelines, buildings, mailboxes, and any other features located within the project area.

Video recordings will begin with an audio narrative which provides the current date and time, the name of the Village and name of project, and a description of both the starting location and the location or locations to be recorded, including street name or names, street addresses, and any additional information which may be necessary to describe the location and subject of viewing.

Video recordings will maintain viewer orientation by means of an audio commentary in the audio track of each video recording which provides an explanation of what is being viewed; and by videotaping landmarks and readily identifiable objects, including property addresses, street signs, or other appropriate objects, at appropriate intervals.

Pre-construction video recordings will be recorded at a rate of travel not exceeding 50 feet per minute, and zooming and panning rates will be controlled to provide clarity of features during playback. The finished product will be provided with bright, clear pictures and accurate colors free from distortion, tearing, rolls, or other forms of picture imperfection. The audio will have proper volume and clarity. All recordings will be performed at times of satisfactory visibility, and when no more than 10 percent of ground is obscured by snow, leaves, or other cover.

If any element within or portion of the project area is not adequately documented by the pre-construction video recording so as to definitively demonstrate its condition prior to the start of construction, Contractor will assume responsibility for the repair, restoration or replacement of that element or portion of the project area. Such repair, restoration or replacement will be to equal or better condition than previously existing, and will further comply with all standards and provisions which govern the work in question.

Schedule. Preconstruction video recording will be performed according to the following schedule:

- (a) Pre-construction video recording will be completed after a Notice to Proceed has been issued.
- (b) Pre-construction video recording will be completed after the Joint Utility Locating Information for Excavators (JULIE) request for the project area has cleared.
- (c) Pre-construction video recording will be completed before any equipment, materials, or other items are delivered to the site.
- (d) Pre-construction video recording will be completed no more than 7 chargeable days prior to the start of construction.
- (e) Pre-construction video recording will be completed, the required pre-construction video recording deliverables will be submitted to the Engineer, and the Engineer will review and issue written approval of the pre-construction video recording before any activity other than utility locating will be permitted to start. Such activity will include, but not be limited to, delivery of materials and equipment, installation of traffic control and erosion control, and completion of construction layout and tree protection. No days will be charged against the contract time while the video is under review by the Engineer, including the day the deliverables are submitted and the day a response is provided. If the pre-construction video recording or any portions thereof are rejected, the contract time will commence to run until revisions are submitted.
- (f) Pre-construction video recording will be submitted to Engineer for review prior to commencement of any construction, and receive acceptance of recordings prior to commencement of construction. Any areas found not acceptable to the Owner will be re-recorded at no additional cost to the contract.

Deliverables. Video will be high-definition, with a minimum resolution of 1280 × 720 pixels per frame. Video will be filmed in a landscape aspect ratio. Video filmed in a portrait aspect ratio will be considered unacceptable and will be rejected.

Preconstruction video recordings will be provided as electronic files of .avi, .mp4, .m4v, .mkv, .wmv, or .mpg file format, or of such other file format as may be approved by Engineer. Preconstruction video recordings will be provided as independent digital container format files, which container files will include all video, audio, and other electronic information necessary to view the preconstruction video recording as intended.

Video DVD will be considered an unacceptable format for providing preconstruction video recordings, and will be rejected.

Pre-construction video recording electronic files will be provided on a portable electronic media device or devices of one of the following types: USB flash drive, SD flash memory card, CF flash memory card, data DVD, external hard drive, or such other portable electronic media device as may be approved by Engineer. Preconstruction video recording electronic files may also be provided via online file sharing, cloud storage, File Transfer Protocol (FTP), or other online or network file transfer methods if approved by Engineer.

Pre-construction video recording electronic files will be accompanied by corresponding logs which document the dates, times, and locations covered by each preconstruction video recording electronic file.

Contractor shall maintain copies of all items submitted to Engineer for Contractor's own use and record.

Method of Measurement. This work will be measured for payment on a lump sum basis. No measurement will be made of the individual components of this effort.

Basis of Payment. Pre-construction video recording will be paid for at the contract lump sum price for PRE-CONSTRUCTION VIDEO RECORDING.

PAY ITEM #79 – CONCRETE REMOVAL (SPECIAL)

Description. This work shall consist of the removal and disposal of existing concrete pads as indicated on the construction documents. This work shall also include excavation and removal of aggregate base.

Method of Measurement. This work will be measured for payment in place and the area computed in square yards.

Basis of Payment. Concrete Removal (Special) shall be paid for at the contract unit price bid per square yard of CONCRETE REMOVAL (SPECIAL).

PAY ITEM #80 – STABILIZED CONSTRUCTION ENTRANCE

Description. This work shall be done in accordance with the applicable portions of Section 281 of the Standard Specifications and shall include the furnishing, installing, maintaining, and removing of the STABILIZED CONSTRUCTION ENTRANCE at locations and per the details shown on the plans.

Coarse Aggregate and geotextile fabric for the STABILIZED CONSTRUCTION ENTRANCE must meet the requirements of the IDOT Standard Specifications, the requirements of the Illinois Urban Manual material Specification 592 and as detailed on the plans, unless otherwise directed by the RESIDENT ENGINEER.

Basis of Payment. This work shall be paid for at the contract unit price bid per square yard measured in place for STABILIZED CONSTRUCTION ENTRANCE, which price shall include removal and disposal of excavated materials, geotechnical fabric; furnishing, placing, compacting and disposing of coarse aggregate; and all labor, tools, and equipment necessary to construct the work as specified.

PAY ITEM #82 – FENCE REMOVAL

Description. This work shall consist of the complete removal of existing chain link fence of varying heights.

The existing chain link fence, backstop, posts and associated concrete footings shall be removed as indicated on the plans or as directed by the Engineer.

Disposal of Materials. Materials resulting from the removal of existing chain link fence as herein specified shall be disposed of offsite by the contractor.

Method of Measurement. This work will be measured for payment in place and the length computed in linear feet.

Basis of Payment. This work will be paid for at the contract unit price per foot for FENCE REMOVAL.

PAY ITEM #83 – 4' BY 4' BOX STRUCTURE

Description. This work shall consist of furnishing and installing the 4' x 4' box structure that is part of the outlet of the new storage basin as shown on the plans. This work shall be performed in accordance with Section 602 of the Standard Specifications.

Materials. 4' x 4' box structure shall be manufactured to meet Section 1042.10 of the Standard Specifications. The box structure can be a precast structure and will have a level top at an elevation indicated on the drawings.

The open grate for the box structure shall be manufactured to meet Section 604 of the Standard Specifications except that the size and dimensions shall be adjusted to conform with the construction detail in the drawings.

Basis of Payment. This work will be paid for at the contract unit price per each for 4' BY 4' BOX STRUCTURE, which price shall include excavation, disposal of excavated material, stabilized base remediation (if necessary), box structure installation, connections to associated storm sewer, grate, adjustments and slope grading as needed.

PAY ITEM #84 – BASEBALL INFIELD MIX

Description. This work shall consist of furnishing and installing 4-inches of infield mix in baseball field infield.

Materials.

1. Baseball Infield Mix: Clean, stone free, approximately 70% sand, 30% clay mixture equivalent to Waupaca Sure-Hop Classic Infield Mix.
2. Infield Conditioner: Calcined, illite clay equivalent to Turface MVP product.

Installation – Baseball Infield Mix and Conditioner

1. Baseball Infield Mix and Conditioner to be installed in the locations and to the dimensions indicated on plans and in accordance with manufacturer's recommendations. Contractor shall mix Conditioner into top 2-3" of Infield Mix such that the final layer of the Infield Mix and Conditioner together is approximately 4 inches total. The ratio of Infield Mix to Conditioner within the ballfield shall be 80% to 20% by volume.
2. The Infield Mix shall be installed over 8" of topsoil (not directly on subgrade). The 8" of topsoil placement shall be included in the cost of the baseball infield mix and conditioner.
3. The finish grade elevations shall be within +/- 1/4" inch of design grade and to within 1/4" of a tightly pulled 25 foot string in any direction. All finished grading shall be accomplished using laser grading to meet the requirements of uniformity and final grade.
4. Finish elevations and uniformity shall be verified by a registered land surveyor at the contractor's expense. The contractor must submit a copy of the survey to the Project Manager as outlined in the Submittals section.

Method of Measurement. This work will be measured for payment in place and the area computed in square yards.

Basis of Payment. Baseball Infield Mix and Conditioner shall be paid for at the contract unit price bid per square yard of BASEBALL INFIELD MIX, which price shall include the 8" of topsoil that is to be placed between the subgrade and baseball infield mix.

PAY ITEM #85 – BASES

Description. This item shall consist of all material, coordination, and labor required to install the bases, home plate and pitcher's mound for the baseball field.

The home plate, pitcher's rubber and the bases shall be official size as used in regulation baseball.

Home base and plates shall include 1" (minimum) all steel anchors that are set in concrete below the surface per the manufacturer's recommendations.

Contractor shall provide product sheets to the Village for approval prior to purchase of materials.

Method of Measurement. This work will be measured for payment on a lump sum basis. No measurement will be made of any of the individual components of this work.

Basis of Payment. Furnishing and installing the bases, home plate and pitcher's mound will be paid for at the contract lump sum price for BASES.

PAY ITEM #86 – BLEACHERS

Description. This work shall consist of furnishing and installing bleachers as indicated on the construction documents.

Materials.

1. Bleachers: National Recreation Systems, Model NA-0515ADA_CLR, 5 row, 15' length, ADA bleacher (36 seats) (or equivalent)

Installation.

1. Comply with manufacturer's written installation instructions, unless more stringent requirements are indicated. Complete field assembly of site furnishings, where required.
2. Unless otherwise indicated, install site furnishings after landscaping and paving have been completed.

3. Install site furnishings level, plumb, true, and positioned at locations indicated on Drawings and approved locations by Owner.
4. Post Setting: Set cast-in support posts in concrete footing with smooth top, shaped to shed water. Protect portion of posts above footing from concrete splatter. Verify that posts are set plumb or at correct angle and are aligned and at correct height and spacing. Hold posts in position during placement and finishing operations until concrete is sufficiently cured.
5. Concrete pad for bleachers shall be installed following IDOT Standard Specification Section 420.

Method of Measurement. This work will be measured for payment as each individual bleacher installed and the unit of measurement will be each.

Basis of Payment. Bleachers shall be paid for at the contract unit price bid per each of BLEACHERS.

PAY ITEM #87 – BOX PACKING CLAY

Description. This work shall consist of furnishing and installing box packing clay in the baseball field infield for the pitcher's mound and batter's and catcher's boxes.

Materials.

1. Box Packing Clays: Turface MoundMaster Blocks or approved equal.
 - a. Clay bricks are 2.5" x 4" x 8"
2. Mound Clay: Turface Professional Mound Clay & Turface Mound & Plate All-Purpose Clay or approved equal.

Installation – Box Packing Clay.

1. The hydraulically packed blocks of clay (Moundmaster Blocks or approved equal) and/or the mound clay shall be installed according to manufacturer's recommendations and as indicated on plans.
2. The manufacture's installation recommendations for the construction of the pitcher's mound and batter's boxes shall be provided to the Village a minimum of two weeks prior to the anticipated construction date and shall include a detailed description of how the proper dimensions, distances, alignment, and height will be achieved.

3. Finish elevations and uniformity shall be verified by a registered land surveyor at the contractor's expense. The contractor must submit a copy of the survey to the Project Manager as outlined in the Submittals section.

Method of Measurement. This work will be measured for payment in place and the area computed in square yards.

Basis of Payment. Box Packing Clay shall be paid for at the contract unit price bid per square yard of BOX PACKING CLAY.

PAY ITEM #88 – COMED PRIMARY SPLICE BOX (INSTALL ONLY)

Description. This item shall consist of all coordination, materials, and labor required to install a splice box furnished by ComEd complete with earth preparation, aggregate base, and grounding per ComEd Standard C5279. The contractor shall coordinate the splice box locations and orientation with ComEd prior to start of construction.

Materials. Materials shall be in accordance with ComEd Specifications and as stated in ComEd Standard C5279 included on the electrical details. ComEd to furnish splice box. Contractor to furnish all other required materials for splice box installation.

Method of Measurement. This work will be measured for payment in place for each splice box installed.

Basis of Payment. This work will be paid for at the contract unit price each for COMED PRIMARY SPLICE BOX (INSTALL ONLY) which shall be payment in full for the work specified herein.

PAY ITEM #89 – CULVERT INLET PROTECTION

Description. This work shall consist of placing, maintaining, and removing culvert inlet protection at locations shown on the plans in accordance with Section 280 of the Standard Specifications. The CONTRACTOR will be responsible for cleaning and maintaining the culvert inlet protection until such time that they can be removed. At the direction of the RESIDENT ENGINEER the CONTRACTOR shall remove the culvert inlet protection and they shall become the property of the CONTRACTOR and be disposed of off-site.

Basis of Payment. This work will be measured for payment at the contract unit price per EACH for CULVERT INLET PROTECTION, which price shall include installing, maintaining, and the removal and disposal of all material.

PAY ITEM #90 – DUGOUT REMOVAL

Description. This work shall consist of the removal and disposal of the existing baseball field dugout structures as indicated on the construction documents.

Unless notified by the Village prior to removal, the contractor shall be responsible for the disposal of the structures and associated materials offsite.

Method of Measurement. This work will be measured for payment as each individual dugout removed and the unit of measurement will be each.

Basis of Payment. Dugout removal shall be paid for at the contract unit price bid per each of DUGUT REMOVAL.

PAY ITEM #91 – ELECTRICAL CABINET, COMPLETE

Description. This item shall consist of furnishing and installing an electrical cabinet complete with enclosure, foundation, concrete pads, conduit sweeps, service wire and conduit (from transformer to distribution panel), interior wiring, distribution panel, circuit breaker panel, CT cabinet and meter, cabinet lighting, cabinet outlets, grounding, and all required hardware as specified herein and as shown on the plans. Catalog cuts must be supplied to and approved by the Engineer prior to ordering material.

Materials. All materials shall be in accordance with Article 1068.01 (2) of the Standard Specifications and the National Electrical Code, except where modified herein.

The electrical cabinet shall be NEMA 3R rated and have a natural aluminum finish. All other exterior electrical equipment for the electrical cabinet shall be NEMA 3R rated and have a gray or a natural aluminum finish.

Cabinet Sizing. The dimensions given on the electrical cabinet detail are for reference only. The contractor is responsible for sizing the electrical cabinet based on the actual dimensions of the electrical equipment proposed in this contract and the dimensions of the future equipment shown on the electrical cabinet detail. The contractor is responsible for modifying the controller cabinet foundation dimensions as required for actual cabinet size.

Installation. The contractor shall install the electrical cabinet according to the plans and as recommended by the manufacturer. The electrical cabinet shall be set plumb on the foundation without the use of shims, grout, or any other leveling devices under the cabinet base.

Certification and Guarantee. The submittal information shall include a written certification of compliance with the contract requirements from the manufacturer. The

certification shall identify the project, location, and contract number as applicable and shall identify specifically the equipment covered by the certification. The certification shall be made on the manufacturer's corporate stationary and dated and signed by a responsible officer of the company with the signee's title listed.

Method of Measurement. This work will be measured for payment in place for each complete cabinet installed.

Basis of Payment. This work will be paid for at the contract unit price per each for ELECTRICAL CABINET, COMPLETE which shall include all labor, splicing, fusing, materials, and equipment to complete the installation as described herein.

PAY ITEM #92 – GRASS PAVERS

Description. This work shall consist of the furnishing and installation of Grass Pavers in the location indicated on the plans. This item also includes topsoil to fill grass pavers. Seeding will be paid for separately under SEEDING, CLASS 1.

Materials. GrassPave2 Interlocking Units or approved equal. Pavers shall be installed per manufacturer's installation requirements.

Grass Pavers shall be placed on 12-inches of aggregate base course (CA-6) which shall be included with the cost of the pavers.

Method of Measurement. This work shall be measured for payment in place and the area computed in square foot.

Basis of Payment. This work will be paid for at the contract unit price per square foot for GRASS PAVERS.

PAY ITEMS #93 AND 94 – GRATING FOR CONCRETE FLARED END SECTION

Description. This work shall consist of furnishing and placing grating for precast reinforced concrete end sections at locations shown on the plans.

Grating for concrete flared end sections shall be of the size specified in the plans and shall be accordance with Article 542.07 (b). Grating shall also meet the requirements of standard 542311 of the IDOT Highway Standards.

Method of Measurement. This work will be measured for payment as each individual grate and the unit of measurement will be each.

Basis of Payment. This work will be paid for at the contract unit price per each for GRATING FOR CONCRETE FLARED END SECTION at the size specified in the plans.

PAY ITEM #95 – LIMESTONE SCREENINGS

Description. This work shall consist of furnishing and installing limestone screenings where indicated outside baseball field fencing and on the warning track as shown on the plans. This work shall be done in accordance with Section 402 of the Standard Specifications with the following exceptions.

The limestone screening area shall consist of 6 inches of compacted sub-base granular material, type B (CA-6), with 4 inches of compacted limestone screenings (FA-5) surface and geotechnical fabric for ground stabilization. The sub-base and geotechnical fabric will not be paid for separately but shall be included in the cost of the limestone screenings.

Basis of Payment. This work will be paid for at the contract unit price per square yard for LIMESTONE SCREENINGS.

PAY ITEM #96 – NETTING

Description. This item shall consist of furnishing and installing the netting system for the Village baseball field as shown on the plans.

Materials.

(7) 62' Long x 12 3/4" OD x .375 thick Black weather treated heavy duty steel poles will be secured in the ground 12' deep utilizing 36" boring and 4,000 psi concrete or PoleCrete (or approved equal) to attain a 50' above ground level.

The 2 poles centered behind home plate will be spaced 20' OC with a pole angled toward 3rd base and 1st base dugouts at 50' OC. There will be 1 additional pole placed further down the 3rd base line and 1st base line 50' OC just beyond the dugouts. An additional pole will be placed 50' OC further up the right field line.

An 8' high Black chain link fence (see Special Provision for CHAIN LINK FENCE) will be installed in front the steel poles.

(5/16") 1 x 7 Galvanized steel strand cable will be secured to the top of each pole utilizing galvanized oval eyebolts and strandvises. Vertical face cables will be installed on each pole. Vinyl coated "X" configuration cables will be installed in between each pole for additional netting stability.

(# 36), 1 ¾" Black, weather treated, rope bordered, on the square baseball netting will be secured to the cables utilizing spring loaded snaps and weather treated twine at the quantities and spacing specified by the manufacturer.

Basis of Payment. This work will be paid for at the contract unit price per lump sum of NETTING which shall include all labor, materials, and equipment to complete the installation as described herein.

PAY ITEM #97 – PEDESTRIAN LIGHT UNIT, COMPLETE

Description. This item shall consist of furnishing and installing a fluted aluminum pole complete with luminaire, lamp, a decorative base, galvanized anchor bolts, fuses, fuse holders, and all required hardware as specified herein and as shown on the plans. Catalog cuts must be supplied to and approved by the Engineer prior to installation.

Materials. All items for the lighting unit shall be Sternberg as shown on the drawings or equivalent. The product proposed currently matches the Village's light fixture used throughout town.

Pole and Decorative Base. The pole shall be fabricated from a one piece, 5" diameter fluted (0.188" wall thickness) of 6061-T6 structural grade aluminum. The pole shall be Sternberg Model #8412FP5 (12' in height) with a 2'-7" decorative base as specified in the plans. A maintenance opening and access door shall be provided with stainless steel allen head screws and one copper ground lug. The base plate shall accept four (4) ¾" x 18" x 3" L-type galvanized anchor bolts with two (2) galvanized nuts and two (2) galvanized washers per bolt. The pole and decorative base shall be prime painted and then finish painted black (Sternberg BK). The pole shall be welded for single unit construction.

Luminaire Fixture. The luminaire shall be comprised of cast aluminum and shall come complete with constant wattage for a 63 watt LED lamp and will deliver an IES Type III distribution. The luminaire shall be Sternberg Model #1230LEDPT with a photocell. The luminaire shall be prime painted and then finish painted black to match the finish of the light pole assembly.

Shipment. The poles shall be carefully inspected at the factory prior to shipment to assure that the poles are complete and free of defects. When poles are stacked together, they shall be supported with suitable spacers or shall otherwise be protected from damage.

Installation. The contractor shall install the lighting unit according to the plans and as recommended by the manufacturer. The light pole shall be set plumb on the foundation without the use of shims, grout, or any other leveling devices under the pole bases. The base cover of the pole shall be flush with the concrete foundation. Poles shall not be

installed until luminaires are available for installation at the same time the poles are installed.

Any damage to the paint finish of the lighting unit after installation shall be touched up in the field by the contractor per the manufacturer's recommendations.

Certification and Guarantee. The submittal information shall include a written certification of compliance with the contract requirements from the manufacturer. The certification shall identify the project, location, section number, and contract number as applicable and shall identify specifically the equipment covered by the certification. The certification shall be made on the manufacturer's corporate stationary and dated and signed by a responsible officer of the company with the signee's title listed.

Basis of Payment. This work will be paid for at the contract unit price per each for PEDESTRIAN LIGHT UNIT, COMPLETE which shall include all labor, splicing, fusing, materials, and equipment to complete the installation as described herein.

PAY ITEM #98 – PEDESTRIAN LIGHT UNIT, FIXTURE ONLY

Description. This item shall consist of furnishing and installing a luminaire fixture, lamp, fuses, fuse holders, and all required hardware as specified herein and as shown on the plans on an existing Village standard pedestrian pole. The contractor shall verify the existing pole diameter prior to ordering the fixture and catalog cuts must be supplied to and approved by the Engineer prior to installation.

Materials. All items for the lighting unit shall be Sternberg as shown on the drawings, or equivalent. The product proposed currently matches the Village's light fixture used throughout town.

Luminaire Fixture. The luminaire shall be comprised of cast aluminum and shall come complete with constant wattage for a 63 watt LED lamp and will deliver an IES Type III distribution. The luminaire shall be Sternberg Model #1230LEDPT with a photocell. The luminaire shall be prime painted and then finish painted black to match the finish of the existing light pole assembly.

Shipment. The fixture shall be carefully inspected at the factory prior to shipment to assure that the poles are complete and free of defects.

Installation. The contractor shall install the lighting fixture according to the plans and as recommended by the manufacturer. The fixture shall be installed on existing Village standard pedestrian poles.

Any damage to the paint finish of the lighting unit after installation shall be touched up in the field by the contractor per the manufacturer's recommendations.

Certification and Guarantee. The submittal information shall include a written certification of compliance with the contract requirements from the manufacturer. The certification shall identify the project, location, section number, and contract number as applicable and shall identify specifically the equipment covered by the certification. The certification shall be made on the manufacturer's corporate stationary and dated and signed by a responsible officer of the company with the signee's title listed.

Basis of Payment. This work will be paid for at the contract unit price per each for PEDESTRIAN LIGHT UNIT, FIXTURE ONLY which shall include all labor, splicing, fusing, materials, and equipment to complete the installation as described herein.

PAY ITEM #99 – PLASTIC FLARED END SECTION

Description. This work shall consist of furnishing and installing the plastic flared end sections at the locations indicated on the plans.

Materials. The plastic flared end section shall be high density polyethylene meeting ASTM D3350.

Method of Measurement. This work will be measured for payment as each individual plastic flared end section installed and the unit of measurement will be each.

Basis of Payment. This work will be paid for at the contract unit price per each for PLASTIC FLARED END SECTION.

PAY ITEMS #100 AND 101 – PLAYING FIELD SEEDING AND SODDING

Description. This work shall consist of furnishing and installing seed and sod in "Field Mix" areas as specified on Landscape Plans. A minimum of one row of sod shall be placed around all edges of infield mix and warning track on baseball field to provide defined edge of field. Only sod shall be used for the infield grass.

The specified seed mix below shall be installed following Section 250 of the Standard Specifications using Bare Earth Seeding method 1.

Materials.

Field Mix Seed – National Seed – Field of Dreams, Game Day Mix, or approved equal.

DELIVERY, STORAGE, AND HANDLING

Seed and Other Packaged Materials: Deliver seed in original sealed, labeled, and undamaged containers showing weight, certified analysis, name and

address of manufacturer, and indication of compliance with state and Federal laws, as applicable.

SCHEDULING

A. Planting Restrictions: Plant during the following periods. Coordinate planting periods with maintenance periods to provide required maintenance from date of Substantial Completion.

1. Planting Seed: August 15 – September 15
March 15 – June 1

B. Weather Limitations: Proceed with planting only when existing and forecasted weather conditions permit planting to be performed when beneficial and optimum results may be obtained.

Sod

Sod shall meet Section 1081.03 of the Standard Specifications and installed per Section 252.

Method of Measurement. This work will be measured for payment in place and the area computed in square yards.

Basis of Payment. This work will be paid for at the contract unit price per square yard for PLAYING FIELD SEEDING and at the contract unit price per square yard PLAYING FIELD SODDING.

PAY ITEM #102 – RAILING

Description. This work shall consist of furnishing and installing the railings along Ardmore Ave in the locations as indicated on the plans.

Railing Specifications

- All Railing materials, fabrication and installation to comply with Section 509 Metal Railings of IDOT Standard Specifications for Road and Bridge Construction (ISSRBC) adopted April 1, 2016.
- Railing and post to be Steel-ASTM A53 Gr B. Fy=35 K.S.I. per Article 1006.18 (ISSRBC).
- Railing fabricator to provide for expansion and contraction of railings, and for change in railing direction per Article 509.05 (ISSRBC).

- Posts and Railings to be cleaned, primed and powder coated. One coat of primer and 2 top coats. Primer to be alkyd based.
- Color to be approved by Owner.
- All Pipe connections to be welded. All welds to be made by Certified Welders and to be made with E70XX electrodes per Section 505 (ISSRBC).

Method of Measurement. This work will be measured for payment in place and the length computed in linear feet.

Basis of Payment. This work will be paid for at the contract unit price per foot for RAILING.

PAY ITEM #103 – REMOVE AND RELOCATE BENCH

Description. This work shall consist of the removal and relocation of the park bench as indicated on the construction documents. This items includes the new footings for the bench as shown in the plans.

Method of Measurement. This work will be measured for payment as each individual bench removed and relocated and the unit of measurement will be each.

Basis of Payment. Remove and replace bench shall be paid for at the contract unit price bid per each of REMOVE AND RELOCATE BENCH.

PAY ITEM #104 – TRANSFORMER PAD

Description. This item shall consist of all material, coordination, and labor required to install a transformer pad complete with earth preparation, aggregate base, and grounding per ComEd Standard C5293. The contractor shall coordinate the transformer pad location and orientation with ComEd prior to start of construction.

Materials. Materials shall be in accordance with ComEd Specifications and as stated in ComEd Standard C5293 included on the electrical details.

Method of Measurement. This work will be measured for payment in place for each transformer pad installed.

Basis of Payment. This work will be paid for at the contract unit price each for TRANSFORMER PAD which shall be payment in full for the work specified herein.

PAY ITEM #105 – UNDERGROUND COMED PRIMARY CONDUIT, 4”

Description. This item shall consist of all material, coordination, and labor required to install 4” conduit for a ComEd primary from the splice point to the proposed transformer as specified on the plans. The contractor shall coordinate the conduit routing and materials with ComEd prior to start of construction.

Materials. Materials shall be in accordance with ComEd Specifications and as stated herein.

ComEd primary conduit is to be Schedule 40 4” PVC installed 36” below final grade. Conduit radiuses and conduit under roadway pavement shall be galvanized steel. Conduit radiuses are to be 48” and the maximum cumulative bends cannot exceed 270 degrees. Conduit is to be pushed under all existing pavement to remain to minimize disruption.

Method of Measurement. This work will be measured for payment in place and the length computed in linear feet.

Basis of Payment. This work will be paid for at the contract unit price linear foot for UNDERGROUND COMED PRIMARY CONDUIT, 4” which shall be payment in full for the work specified herein.

PAY ITEM #106 – CONTINGENCY ALLOWANCE

Description. A contingency allowance pay item is provided as a part of this contract for the purpose of facilitating the completion of unforeseen or additional work not included in the contract as awarded, and which is determined by the Engineer to be necessary and germane to the contract.

Use of the contingency allowance will be at the discretion of the Engineer. The Engineer may, at the Engineer’s discretion, use the contingency allowance for any of the following reasons:

- (a) Facilitate a temporary payment allowance to the Contractor for work completed under existing contract pay items and for which completed quantities exceed contract quantities;
- (b) Facilitate a temporary payment allowance to the Contractor for work completed beyond the scope of existing contract pay items; or
- (c) Facilitate a temporary payment allowance to the Contractor for the purchase of equipment, materials or such other requisition as Engineer determines to be necessary for the completion of the Work.

Such use of the CONTINGENCYALLOWANCE will be further subject to approval by the Village. The Village's decision with regard to use of the CONTINGENCYALLOWANCE will be final.

A. Any payments made to Contractor under the CONTINGENCY ALLOWANCE will be considered temporary, and will only be retained by Contractor until such time that an authorization of contract changes can be approved and incorporated into the contract.

B. Contractor, in accepting payments made under the CONTINGENCYALLOWANCE, agrees to the terms of this and other applicable special provisions. Contractor agrees to relinquish any monies and any claim to monies paid under the CONTINGENCYALLOWANCE upon approval of an authorization of contract changes and payment for any work for which payment was previously made under the CONTINGENCYALLOWANCE. Contractor further agrees to return any monies previously paid thereunder.

C. The CONTINGENCYALLOWANCE pay item for this contract has been established with a unit of measurement in dollars, a quantity of 50,000.00, and a contract unit price of one dollar (\$1.00), for a total CONTINGENCYALLOWANCE contract price of 50,000 dollars and no cents (\$50,000.00). Bidder, in submitting a bid, accepts the quantity, contract unit price, and total contract price of the CONTINGENCYALLOWANCE.

Basis of Payment. This work will be paid for at the contract unit price per dollar for CONTINGENCYALLOWANCE. The total bid amount for this item will be \$50,000.00.

PAY ITEM #107 – WATER USAGE CREDIT

Description. Pay items are provided as a part of this contract for the purpose of documenting the quantity of water obtained from the Village by the Contractor.

If the Contractor elects to obtain water from the Village, the Contractor shall comply with the Special Provision USE OF FIRE HYDRANTS. The quantity of water obtained from the Village by the Contractor shall be deducted from the contract as WATER USAGE DEDUCTION, and shall be credited to the contract as WATER USAGE CREDIT.

The WATER USAGE CREDIT pay item for this contract has been established with a unit of measurement in thousands of gallons (TGAL), a quantity of one-hundred (100.00), and a contract unit price of eight dollars and eighty-five cents (\$8.85), for a total WATER USAGE CREDIT contract price of eight-hundred eighty-five dollars and no cents (\$885.00). Bidder, in submitting a bid, accepts the quantity, contract unit price, and total contract price of the WATER USAGE CREDIT pay item.

Method of Measurement. Water usage will be measured as the actual quantity of water obtained from the Village by the Contractor, which quantity shall be rounded up to the nearest 1,000 gallons.

Basis of Payment. The water usage credit will be paid for at the contract unit price per thousand gallons (TGAL) for WATER USAGE CREDIT. The quantity paid for as WATER USAGE CREDIT will be equal to the quantity deducted as WATER USAGE DEDUCTION.

PAY ITEM #108 – WATER USAGE DEDUCTION

Description. Pay items are provided as a part of this contract for the purpose of documenting the quantity of water obtained from the Village by the Contractor.

If the Contractor elects to obtain water from the Village, the Contractor shall comply with the Special Provision USE OF FIRE HYDRANTS. The quantity of water obtained from the Village by the Contractor shall be deducted from the contract as WATER USAGE DEDUCTION, and shall be credited to the contract as WATER USAGE CREDIT.

The WATER USAGE DEDUCTION pay item for this contract has been established with a unit of measurement in thousands of gallons (TGAL), a quantity of one-hundred (100.00), and a contract unit price of a deduction of eight dollars and eighty-five cents (\$8.85), for a total WATER USAGE DEDUCTION contract price of a deduction of eight-hundred eighty-five dollars and no cents (\$885.00). Bidder, in submitting a bid, accepts the quantity, contract unit price, and total contract price of the WATER USAGE DEDUCTION pay item.

Method of Measurement. Water usage will be measured as the actual quantity of water obtained from the Village by the Contractor, which quantity shall be rounded up to the nearest 1,000 gallons.

Basis of Payment. The water usage deduction will be deducted at the contract unit price per thousand gallons (TGAL) for WATER USAGE DEDUCTION. The quantity deducted as WATER USAGE DEDUCTION will be equal to the quantity paid for as WATER USAGE CREDIT.

OWNER COPY

CONTRACT

OWNER COPY

CONTRACT
JACKSON POND OVERFLOW PROJECT
VILLAGE OF VILLA PARK

APPENDIX A
REQUIREMENTS OF BIDDERS ORDINANCE

OWNER COPY

CONTRACT

Ordinance No. 3733**AN ORDINANCE OF THE VILLAGE OF VILLA PARK, DUPAGE COUNTY, ILLINOIS AMENDING THE REQUIREMENTS OF BIDDERS FOR CONSTRUCTION PROJECTS**

WHEREAS, the Village of Villa Park (the “*Village*”) is a duly organized and validly existing non home-rule municipality created in accordance with the Constitution of the State of Illinois of 1970 and the laws of the State; and,

WHEREAS, section 8-9-1 of the Illinois Municipal Code (65 ILCS 5/8-9-2) allows the Village to require competitive bidding after advertising for bids in the manner prescribed by ordinance; and,

WHEREAS, the President and Board of Trustees desire to adopt purchasing procedures to provide for additional requirements of bidders for construction projects to have active apprenticeship and training programs approved and registered with the United States Department of Labor’s Bureau of Apprenticeship and Training and to have bidders show three similar projects they constructed within the last five years.

NOW, THEREFORE, BE IT ORDAINED by the President and Board of Trustees of the Village of Villa Park, DuPage County, Illinois, as follows:

Section 1. That Section 2-219 of the Villa Park Municipal Code, as amended, be and is hereby amended by placing the existing text as subsection A. and adding a new subsection B. to read as follows:

“B. A responsible bidder for the construction of public works projects shall meet and submit evidence of compliance with the following requirements:

- (1) All applicable laws prerequisite to doing business in the State of Illinois,
- (2) A federal employer tax identification number or social security number,
- (3) Provision of Section 2000(e) of Chapter 21, Title 42 of the United States Code and Federal Executive Order No. 11246 as amended by Executive Order No. 11375 (known as the Equal Opportunity Employer provisions),
- (4) Certificates of insurance indicating the following coverage’s: general liability, worker’s compensation, completed operations, automobile, hazardous occupation and product liability
- (5) Compliance with all provisions of the Illinois Prevailing Wage Act, including wages, medical and hospitalization insurance and retirement for those trades covered in the Act,
- (6) The bidder and all bidder’s sub-contractors must participate in active apprenticeship and training programs approved and registered with the United States Department of Labor’s Bureau of Apprenticeship and Training for each of the trades of work contemplated under the proposed contract,
- (7) All contractors and sub-contractors are required to file certified payrolls as specified in Illinois Pubic Act 94-0515, and follow all provisions of the Employee Classification Act (820 ILCS 185/1 et seq.), and

(8) All bidders must provide three (3) projects of a similar nature constructed in the immediate past five (5) years with the name, address and telephone number of the contact person having knowledge of the project along with three (3) references (name, address, and telephone number) with knowledge of the integrity and business practices of the bidder.”

Section 2. This Ordinance shall be in full force and effect upon its passage, approval, and publication as provided by law.

Passed this 11 day of February, 2013.

AYES: ALL

NAYS: Aiello Bulthuis

ABSENT: _____

Approved this 11 day of February, 2013.

Village President

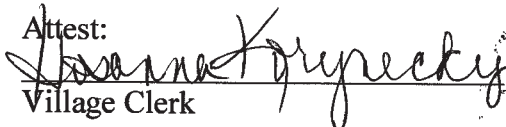
Attest:

Village Clerk



Published in pamphlet form:
2-11, 2013

OWNER COPY

CONTRACT
JACKSON POND OVERFLOW PROJECT
VILLAGE OF VILLA PARK

APPENDIX B

IRMA CONTRACTUAL INSURANCE GUIDELINES

OWNER COPY

CONTRACT

**IRMA
CONTRACTUAL INSURANCE GUIDELINES**

I. INSURANCE REQUIREMENTS

Contractor shall procure and maintain, for the duration of the contract, insurance against claims for injuries to persons or damages to property, which may arise from or in connection with the performance of the work hereunder by the Contractor, his agents, representatives, employees or subcontractors.

MINIMUM SCOPE OF INSURANCE

Coverage shall be at least as broad as:

- A. Insurance Services Office Commercial General Liability occurrence form CG 0001 with the member named as additional insured, on a form at least as broad as the attached sample endorsement including ISO Additional Insured Endorsement CG 2010 (Exhibit A), CG 2026 (Exhibit B).

CG2037 - Completed Operations – (Exhibit C)

Required if box is checked ; and

- B. Owners and Contractors Protective Liability (OCP) policy with the member as insured

Required if box is checked ; and

- C. Insurance Service Office Business Auto Liability coverage form number CA 0001, Symbol 01 "Any Auto."

- D. Workers' Compensation as required by the Workers' Compensation Act of the State of Illinois and Employers' Liability insurance.

Coverage required for employee exposure to lead, if box is checked

- E. Builder Risk Property Coverage with member as loss payee

Required if box is checked .

- F. Environmental Impairment/Pollution Liability Coverage for pollution incidents as a result of a claim for bodily injury, property damage or remediation costs from an incident at, on or migrating beyond the contracted work site. Coverage shall be extended to Non-Owned Disposal sites resulting from a pollution incident at, on or mitigating beyond the site; and also provide coverage for incidents occurring during transportation of pollutants.

Required if box is checked .

MINIMUM LIMITS OF INSURANCE

Contractor shall maintain limits no less than the following, **if required under above scope**:

- A. Commercial General Liability: \$1,000,000 combined single limit per occurrence for bodily injury, and property damage and \$1,000,000 per occurrence for personal injury. The general aggregate shall be twice the required occurrence limit.

Minimum General Aggregate shall be no less than \$2,000,000 or a project/contract specific aggregate of \$1,000,000.

- B. Owners and Contractors Protective Liability (OCP): \$1,000,000 combined single limit per occurrence for bodily injury and property damage.
- C. Business Automobile Liability: \$1,000,000 combined single limit per accident for bodily injury and property damage.
- D. Workers' Compensation and Employers' Liability: Workers' Compensation coverage with statutory limits and Employers' Liability limits of \$500,000 per accident.
- E. Builder's Risk: Shall insure against "All Risk" of physical damage, including water damage (flood and hydrostatic pressure not excluded), on a completed replacement cost basis.
- F. Environmental Impairment/Pollution Liability: \$1,000,000 combined single limit per occurrence for bodily injury, property damage and remediation costs.

DEDUCTIBLES AND SELF-INSURED RETENTIONS

Any deductibles or self-insured retentions must be declared to and approved by the member. At the option of the member, either: the insurer shall reduce or eliminate such deductibles or self-insured retentions as respects the member, its officials, employees, agents and volunteers; or the Contractor shall procure a bond guaranteeing payment of losses and related investigation, claim administration and defense expenses.

OTHER INSURANCE PROVISIONS

The policies are to contain, or be endorsed to contain, the following provisions:

A. General Liability and Automobile Liability Coverages

1. The member, its officials, agents, employees and volunteers are to be covered as additional insureds as respects: liability arising out of the Contractor's work, including activities performed by or on behalf of the Contractor; products and completed operations of the Contractor; premises owned, leased or used by the Contractor; or automobiles owned, leased, hired or borrowed by the Contractor. The coverage shall contain no special limitations on the scope of protection afforded to the member, its officials, agents, employees and volunteers.
2. The Contractor's insurance coverage shall be primary as respects the member, its officials, employees, agents and volunteers. Any insurance or self-insurance maintained by the member, its officials, agents, employees and volunteers shall be excess of Contractor's insurance and shall not contribute with it.
3. Any failure to comply with reporting provisions of the policies shall not affect coverage provided to the member, its officials, employees, agents and volunteers.
4. The Contractor's insurance shall contain a Severability of Interests/Cross Liability clause or language stating that Contractor's insurance shall apply separately to each insured against whom claim is made or suit is brought,

except with respect to the limits of the insurer's liability.

5. If any commercial general liability insurance is being provided under an excess or umbrella liability policy that does not "follow form," then the Contractor shall be required to name the member, its officials, employees, agents and volunteers as additional insureds.
6. All general liability coverages shall be provided on an occurrence policy form. Claims-made general liability policies will not be accepted.
7. The contractor and all subcontractors hereby agree to waive any limitation as to the amount of contribution recoverable against them by member. This specifically includes any limitation imposed by any state statute, regulation, or case law including any Workers' Compensation Act provision that applies a limitation to the amount recoverable in contribution such as Kotecki v. Cyclops Welding.

B. Workers' Compensation and Employers' Liability Coverage

The insurer shall agree to waive all rights of subrogation against the member, its officials, employees, agents and volunteers for losses arising from work performed by Contractor for the municipality.

1. NCCI Alternate Employer Endorsement (WC 000301) in place to insure that workers' compensation coverage applies under contractor's coverage rather than member's if the member is borrowing, leasing or in day to day control of contractor's employee.

Required if box is checked .

C. Professional Liability (Required if box is checked)

1. Professional liability insurance with limits not less than \$1,000,00 each claim with respect to negligent acts, errors and omissions in connection with professional services to be provided under the contract, with a deductible not-to-exceed \$50,000 without prior written approval.
2. If the policy is written on a claims-made form, the retroactive date must be equal to or preceding the effective date of the contract. In the event the policy is cancelled, non-renewed or switched to an occurrence form, the Contractor shall be required to purchase supplemental extending reporting period coverage for a period of not less than three (3) years.
3. Provide a certified copy of actual policy for review.
4. Recommended Required Coverage (architect, engineer, surveyor, consultant): Professional liability insurance that provides indemnification and defense for injury or damage arising out of acts, errors, or omissions in providing the following professional services, but not limited to the following:
 - a. Preparing, approving or failure to prepare or approve maps, drawings, opinions, report, surveys, change orders, designs or specifications;
 - b. Providing direction, instruction, supervision, inspection, engineering services

or failing to provide them, if that is the primary cause of injury or damage.

D. All Coverages

Each insurance policy required shall have the member expressly endorsed onto the policy as a Cancellation Notice Recipient. Should any of the policies be cancelled before the expiration date thereof, notice will be delivered in accordance with the policy provisions.

ACCEPTABILITY OF INSURERS

Insurance is to be placed with insurers with a Best's rating of no less than A-, VII and licensed to do business in the State of Illinois.

VERIFICATION OF COVERAGE

Contractor shall furnish the member with certificates of insurance naming the member, its officials, employees, agents and volunteers as additional insureds (Exhibit D), and with original endorsements affecting coverage required by this clause. The certificates and endorsements for each insurance policy are to be signed by a person authorized by that insurer to bind coverage on its behalf. The certificates and endorsements are to be received and approved by the member before any work commences. The following additional insured endorsements may be utilized: ISO Additional Insured Endorsements CG 2010 (Exhibit A) or CG 2026 (Exhibit B), and CG 2037 (Exhibit C) – Completed Operations, where required. The member reserves the right to request full certified copies of the insurance policies and endorsements.

SUBCONTRACTORS

Contractor shall include all subcontractors as insureds under its policies or shall furnish separate certificates and endorsements for each subcontractor. All coverages for subcontractors shall be subject to all of the requirements stated herein.

ASSUMPTION OF LIABILITY

The contractor assumes liability for all injury to or death of any person or persons including employees of the contractor, any sub-contractor, any supplier or any other person and assumes liability for all damage to property sustained by any person or persons occasioned by or in any way arising out of any work performed pursuant to this agreement.

II. INDEMNITY/HOLD HARMLESS PROVISION

To the fullest extent permitted by law, the Contractor hereby agrees to defend, indemnify and hold harmless the member, its officials, employees and agents against all injuries, deaths, loss, damages, claims, patent claims, suits, liabilities, judgments, cost and expenses, which may in anywise accrue against the member, its officials, agents and employees, arising in whole or in part or in consequence of the performance of this work by the Contractor, its employees, or subcontractors, or which may in anywise result therefore, except that arising out of the sole legal cause of the member, its employees or agents, the Contractor shall, at its own expense, appear, defend and pay all charges of attorneys and all costs and other expenses arising therefore or incurred in connections therewith, and, if any judgment shall be rendered against the member, its officials, employees and agents, in

any such action, the Contractor shall, at its own expense, satisfy and discharge the same.

Contractor expressly understands and agrees that any performance bond or insurance policies required by this contract, or otherwise provided by the Contractor, shall in no way limit the responsibility to indemnify, keep and save harmless and defend the member, its officials, employees and agents as herein provided.

The Contractor further agrees that to the extent that money is due the Contractor by virtue of this contract as shall be considered necessary in the judgment of the member, may be retained by the member to protect itself against said loss until such claims, suits, or judgments shall have been settled or discharged and/or evidence to that effect shall have been furnished to the satisfaction of the member.

III. **SAFETY/LOSS PREVENTION**

Safety/Loss Prevention Program Requirements

- Successful bidder will provide written confirmation that a safety/loss prevention program was in place at least 90 days prior to submitting the bid proposal.
- Evidence of completed employee safety training can be provided.

Regulatory Requirements

- Successful bidder must comply with all applicable laws, regulations, and rules promulgated by any Federal, State, County, Municipal and/or other governmental unit or regulatory body now in effect or which may be in effect during the performance of the work. Included within the scope of the laws, regulations, and rules referred to in this paragraph but in no way to operate as a limitation, are Occupational Safety & Health Act (OSHA), Illinois Department of Labor (IDOL), Department of Transportation, all forms of traffic regulations, public utility, Intrastate and Interstate Commerce Commission regulations, Workers' Compensation Laws, Prevailing Wage Laws, the Social Security Act of the Federal Government and any of its titles, the Illinois Department of Human Rights, Human Rights Commission, or EEOC statutory provisions and rules and regulations.
- Evidence of specific regulatory compliance will be provided by bidder, if required by owner.

EXHIBIT A

POLICY NUMBER:

COMMERCIAL GENERAL LIABILITY
CG 20 10 07 04

THIS ENDORSEMENT CHANGES THE POLICY. PLEASE READ IT CAREFULLY.

**ADDITIONAL INSURED – OWNERS, LESSEES OR
CONTRACTORS – SCHEDULED PERSON OR
ORGANIZATION**

This endorsement modifies insurance provided under the following:

COMMERCIAL GENERAL LIABILITY COVERAGE PART

SCHEDULE

Name Of Additional Insured Person(s) Or Organization(s):	Location(s) Of Covered Operations
<p style="font-size: 48px; opacity: 0.3; transform: rotate(-45deg);">SAMPLE</p>	
<p>Information required to complete this Schedule, if not shown above, will be shown in the Declarations.</p>	

A. Section II – Who Is An Insured is amended to include as an additional insured the person(s) or organization(s) shown in the Schedule, but only with respect to liability for "bodily injury," "property damage" or "personal and advertising injury" caused, in whole or in part, by:

1. Your acts or omissions; or
2. The acts or omissions of those acting on your behalf;

in the performance of your ongoing operations for the additional insured(s) at the location(s) designated above.

B. With respect to the insurance afforded to these additional insureds, the following additional exclusions apply:

This insurance does not apply to "bodily injury" or "property damage" occurring after:

1. All work, including materials, parts or equipment furnished in connection with such work, on the project (other than service, maintenance or repairs) to be performed by or on behalf of the additional insured(s) at the location of the covered operations has been completed; or
2. That portion of "your work" out of which the injury or damage arises has been put to its intended use by any person or organization other than another contractor or subcontractor engaged in performing operations for a principal as a part of the same project.

EXHIBIT B

POLICY NUMBER:

COMMERCIAL GENERAL LIABILITY
CG 20 26 07 04

THIS ENDORSEMENT CHANGES THE POLICY. PLEASE READ IT CAREFULLY.

**ADDITIONAL INSURED – DESIGNATED
PERSON OR ORGANIZATION**

This endorsement modifies insurance provided under the following:

COMMERCIAL GENERAL LIABILITY COVERAGE PART

SCHEDULE

Name Of Additional Insured Person(s) Or Organization(s)
<p style="font-size: 48px; opacity: 0.3; transform: rotate(-45deg);">SAMPLE</p>
Information required to complete this Schedule, if not shown above, will be shown in the Declarations.

Section II – Who Is An Insured is amended to include as an additional insured the person(s) or organization(s) shown in the Schedule, but only with respect to liability for "bodily injury", "property damage" or "personal and advertising injury" caused, in whole or in part, by your acts or omissions or the acts or omissions of those acting on your behalf:

- A. In the performance of your ongoing operations; or
- B. In connection with your premises owned by or rented to you.

EXHIBIT C

POLICY NUMBER:

COMMERCIAL GENERAL LIABILITY
CG 20 37 07 04

THIS ENDORSEMENT CHANGES THE POLICY. PLEASE READ IT CAREFULLY.

**ADDITIONAL INSURED – OWNERS, LESSEES OR
CONTRACTORS – COMPLETED OPERATIONS**

This endorsement modifies insurance provided under the following:

COMMERCIAL GENERAL LIABILITY COVERAGE PART

SCHEDULE

Name Of Additional Insured Person(s) Or Organization(s):	Location And Description Of Completed Operations
<p>EXAMPLE</p>	
<p>Information required to complete this Schedule, if not shown above, will be shown in the Declarations.</p>	

Section II – Who Is An Insured is amended to include as an additional insured the person(s) or organization(s) shown in the Schedule, but only with respect to liability for "bodily injury" or "property damage" caused, in whole or in part, by "your work" at the location designated and described in the schedule of this endorsement performed for that additional insured and included in the "products-completed operations hazard".

OWNER COPY

CONTRACT

**JACKSON POND OVERFLOW PROJECT
VILLAGE OF VILLA PARK**

APPENDIX C

INDEX FOR SUPPLEMENTAL AND RECURRING SPECIAL PROVISIONS
CHECK SHEET FOR RECURRING SPECIAL PROVISIONS
CHECK SHEET FOR LOCAL ROADS & STREETS RECURRING SPECIAL PROVISIONS
BDE SPECIAL PROVISIONS
SPECIAL PROVISION FOR INSURANCE (LR 107-4)
SPECIAL PROVISION FOR EQUIPMENT RENTAL RATES (LR 109)

OWNER COPY

CONTRACT

INDEX
FOR
SUPPLEMENTAL SPECIFICATIONS
AND RECURRING SPECIAL PROVISIONS

Adopted January 1, 2018

This index contains a listing of SUPPLEMENTAL SPECIFICATIONS, frequently used RECURRING SPECIAL PROVISIONS, and LOCAL ROADS AND STREETS RECURRING SPECIAL PROVISIONS.

ERRATA Standard Specifications for Road and Bridge Construction
(Adopted 4-1-16) (Revised 1-1-18)

SUPPLEMENTAL SPECIFICATIONS

<u>Std. Spec. Sec.</u>	<u>Page No.</u>
106 Control of Materials	1
403 Bituminous Surface Treatment (Class A-1, A-2, A-3)	2
404 Micro-Surfacing and Slurry Sealing	3
405 Cape Seal	14
420 Portland Cement Concrete Pavement	24
442 Pavement Patching	26
502 Excavation for Structures	27
503 Concrete Structures	29
504 Precast Concrete Structures	32
542 Pipe Culverts	33
586 Sand Backfill for Vaulted Abutments	34
630 Steel Plate Beam Guardrail	36
631 Traffic Barrier Terminals	39
670 Engineer's Field Office and Laboratory	40
701 Work Zone Traffic Control and Protection	41
704 Temporary Concrete Barrier	42
781 Raised Reflective Pavement Markers	44
888 Pedestrian Push-Button	45
1003 Fine Aggregates	46
1004 Coarse Aggregates	47
1006 Metals	50
1020 Portland Cement Concrete	51
1050 Poured Joint Sealers	53
1069 Pole and Tower	55
1077 Post and Foundation	56
1096 Pavement Markers	57
1101 General Equipment	58
1102 Hot-Mix Asphalt Equipment	59
1103 Portland Cement Concrete Equipment	61
1106 Work Zone Traffic Control Devices	63

OWNER COPY

CONTRACT



The Following Recurring Special Provisions Indicated By An "X" Are Applicable To This Contract And Are Included By Reference:

Recurring Special Provisions

<u>Check Sheet #</u>		<u>Page No.</u>
1	<input type="checkbox"/> Additional State Requirements for Federal-Aid Construction Contracts	64
2	<input type="checkbox"/> Subletting of Contracts (Federal-Aid Contracts)	67
3	<input type="checkbox"/> EEO	68
4	<input type="checkbox"/> Specific EEO Responsibilities Non Federal-Aid Contracts	78
5	<input type="checkbox"/> Required Provisions - State Contracts	83
6	<input type="checkbox"/> Asbestos Bearing Pad Removal	89
7	<input type="checkbox"/> Asbestos Waterproofing Membrane and Asbestos Hot-Mix Asphalt Surface Removal	90
8	<input type="checkbox"/> Temporary Stream Crossings and In-Stream Work Pads	91
9	<input type="checkbox"/> Construction Layout Stakes Except for Bridges	92
10	<input checked="" type="checkbox"/> Construction Layout Stakes	95
11	<input type="checkbox"/> Use of Geotextile Fabric for Railroad Crossing	98
12	<input type="checkbox"/> Subsealing of Concrete Pavements	100
13	<input type="checkbox"/> Hot-Mix Asphalt Surface Correction	104
14	<input type="checkbox"/> Pavement and Shoulder Resurfacing	106
15	<input type="checkbox"/> Patching with Hot-Mix Asphalt Overlay Removal	107
16	<input type="checkbox"/> Polymer Concrete	109
17	<input type="checkbox"/> PVC Pipeliner	111
18	<input type="checkbox"/> Bicycle Racks	112
19	<input type="checkbox"/> Temporary Portable Bridge Traffic Signals	114
20	<input type="checkbox"/> Work Zone Public Information Signs	116
21	<input type="checkbox"/> Nighttime Inspection of Roadway Lighting	117
22	<input type="checkbox"/> English Substitution of Metric Bolts	118
23	<input type="checkbox"/> Calcium Chloride Accelerator for Portland Cement Concrete	119
24	<input type="checkbox"/> Quality Control of Concrete Mixtures at the Plant	120
25	<input checked="" type="checkbox"/> Quality Control/Quality Assurance of Concrete Mixtures	128
26	<input type="checkbox"/> Digital Terrain Modeling for Earthwork Calculations	144
27	<input type="checkbox"/> Reserved	146
28	<input type="checkbox"/> Preventive Maintenance - Bituminous Surface Treatment	147
29	<input type="checkbox"/> Reserved	153
30	<input type="checkbox"/> Reserved	154
31	<input type="checkbox"/> Reserved	155
32	<input type="checkbox"/> Temporary Raised Pavement Markers	156
33	<input type="checkbox"/> Restoring Bridge Approach Pavements Using High-Density Foam	157
34	<input type="checkbox"/> Portland Cement Concrete Inlay or Overlay	160
35	<input type="checkbox"/> Portland Cement Concrete Partial Depth Hot-Mix Asphalt Patching	164

OWNER COPY

CONTRACT

The Following Local Roads And Streets Recurring Special Provisions Indicated By An "X" Are Applicable To This Contract And Are Included By Reference:

Local Roads And Streets Recurring Special Provisions

<u>Check Sheet #</u>		<u>Page No.</u>
LRS 1	Reserved	168
LRS 2	<input type="checkbox"/> Furnished Excavation	169
LRS 3	<input checked="" type="checkbox"/> Work Zone Traffic Control Surveillance	170
LRS 4	<input checked="" type="checkbox"/> Flaggers in Work Zones	171
LRS 5	<input checked="" type="checkbox"/> Contract Claims	172
LRS 6	<input checked="" type="checkbox"/> Bidding Requirements and Conditions for Contract Proposals	173
LRS 7	<input type="checkbox"/> Bidding Requirements and Conditions for Material Proposals	179
LRS 8	Reserved	185
LRS 9	<input type="checkbox"/> Bituminous Surface Treatments	186
LRS 10	Reserved	187
LRS 11	<input checked="" type="checkbox"/> Employment Practices	188
LRS 12	<input checked="" type="checkbox"/> Wages of Employees on Public Works	190
LRS 13	<input checked="" type="checkbox"/> Selection of Labor	192
LRS 14	<input type="checkbox"/> Paving Brick and Concrete Paver Pavements and Sidewalks	193
LRS 15	<input checked="" type="checkbox"/> Partial Payments	196
LRS 16	<input checked="" type="checkbox"/> Protests on Local Lettings	197
LRS 17	<input checked="" type="checkbox"/> Substance Abuse Prevention Program	198
LRS 18	<input type="checkbox"/> Multigrade Cold Mix Asphalt	199

OWNER COPY

CONTRACT

BDE SPECIAL PROVISIONS
For the November 9, 2018 Letting

The following special provisions indicated by a "check mark" are applicable to this contract and will be included by the Project Development and Implementation Section of the BD&E. An * indicates a new or revised special provision for the letting.

File Name	#		Special Provision Title	Effective	Revised
80099	1	<input type="checkbox"/>	Accessible Pedestrian Signals (APS)	April 1, 2003	Jan. 1, 2014
80382	2	<input checked="" type="checkbox"/>	Adjusting Frames and Grates	April 1, 2017	
80274	3	<input type="checkbox"/>	Aggregate Subgrade Improvement	April 1, 2012	April 1, 2016
80192	4	<input type="checkbox"/>	Automated Flagger Assistance Device	Jan. 1, 2008	
80173	5	<input type="checkbox"/>	Bituminous Materials Cost Adjustments	Nov. 2, 2006	Aug. 1, 2017
80241	6	<input type="checkbox"/>	Bridge Demolition Debris	July 1, 2009	
50261	7	<input type="checkbox"/>	Building Removal-Case I (Non-Friable and Friable Asbestos)	Sept. 1, 1990	April 1, 2010
50481	8	<input type="checkbox"/>	Building Removal-Case II (Non-Friable Asbestos)	Sept. 1, 1990	April 1, 2010
50491	9	<input type="checkbox"/>	Building Removal-Case III (Friable Asbestos)	Sept. 1, 1990	April 1, 2010
50531	10	<input type="checkbox"/>	Building Removal-Case IV (No Asbestos)	Sept. 1, 1990	April 1, 2010
80366	11	<input type="checkbox"/>	Butt Joints	July 1, 2016	
80386	12	<input type="checkbox"/>	Calcium Aluminate Cement for Class PP-5 Concrete Patching	Nov. 1, 2017	
* 80396	13	<input type="checkbox"/>	Class A and B Patching	Jan. 1, 2018	Nov. 1, 2018
80384	14	<input checked="" type="checkbox"/>	Compensable Delay Costs	June 2, 2017	
80198	15	<input checked="" type="checkbox"/>	Completion Date (via calendar days)	April 1, 2008	
80199	16	<input type="checkbox"/>	Completion Date (via calendar days) Plus Working Days	April 1, 2008	
80293	17	<input type="checkbox"/>	Concrete Box Culverts with Skews > 30 Degrees and Design Fills ≤ 5 Feet	April 1, 2012	July 1, 2016
80311	18	<input type="checkbox"/>	Concrete End Sections for Pipe Culverts	Jan. 1, 2013	April 1, 2016
80277	19	<input type="checkbox"/>	Concrete Mix Design – Department Provided	Jan. 1, 2012	April 1, 2016
80261	20	<input checked="" type="checkbox"/>	Construction Air Quality – Diesel Retrofit	June 1, 2010	Nov. 1, 2014
80387	21	<input type="checkbox"/>	Contrast Preformed Plastic Pavement Marking	Nov. 1, 2017	
80029	22	<input type="checkbox"/>	Disadvantaged Business Enterprise Participation	Sept. 1, 2000	April 2, 2018
* 80402	23	<input type="checkbox"/>	Disposal Fees	Nov. 1, 2018	
80378	24	<input type="checkbox"/>	Dowel Bar Inserter	Jan. 1, 2017	Jan. 1, 2018
80388	25	<input type="checkbox"/>	Equipment Parking and Storage	Nov. 1, 2017	
80229	26	<input type="checkbox"/>	Fuel Cost Adjustment	April 1, 2009	Aug. 1, 2017
80304	27	<input type="checkbox"/>	Grooving for Recessed Pavement Markings	Nov. 1, 2012	Nov. 1, 2017
80246	28	<input checked="" type="checkbox"/>	Hot-Mix Asphalt – Density Testing of Longitudinal Joints	Jan. 1, 2010	Aug. 1, 2018
80398	29	<input type="checkbox"/>	Hot-Mix Asphalt – Longitudinal Joint Sealant	Aug. 1, 2018	
* 80399	30	<input type="checkbox"/>	Hot-Mix Asphalt – Oscillatory Roller	Aug. 1, 2018	Nov. 1, 2018
80347	31	<input type="checkbox"/>	Hot-Mix Asphalt – Pay for Performance Using Percent Within Limits – Jobsite Sampling	Nov. 1, 2014	Aug. 1, 2018
80383	32	<input type="checkbox"/>	Hot-Mix Asphalt – Quality Control for Performance	April 1, 2017	Nov. 1, 2017
80376	33	<input checked="" type="checkbox"/>	Hot-Mix Asphalt – Tack Coat	Nov. 1, 2016	
80392	34	<input type="checkbox"/>	Lights on Barricades	Jan. 1, 2018	
80336	35	<input type="checkbox"/>	Longitudinal Joint and Crack Patching	April 1, 2014	April 1, 2016
80393	36	<input type="checkbox"/>	Manholes, Valve Vaults, and Flat Slab Tops	Jan. 1, 2018	March 2, 2018
80400	37	<input type="checkbox"/>	Mast Arm Assembly and Pole	Aug. 1, 2018	
80045	38	<input type="checkbox"/>	Material Transfer Device	June 15, 1999	Aug. 1, 2014
80394	39	<input type="checkbox"/>	Metal Flared End Section for Pipe Culverts	Jan. 1, 2018	April 1, 2018
80165	40	<input type="checkbox"/>	Moisture Cured Urethane Paint System	Nov. 1, 2006	Jan. 1, 2010
80349	41	<input type="checkbox"/>	Pavement Marking Blackout Tape	Nov. 1, 2014	April 1, 2016
80371	42	<input type="checkbox"/>	Pavement Marking Removal	July 1, 2016	
80390	43	<input type="checkbox"/>	Payments to Subcontractors	Nov. 2, 2017	
80377	44	<input type="checkbox"/>	Portable Changeable Message Signs	Nov. 1, 2016	April 1, 2017
80389	45	<input checked="" type="checkbox"/>	Portland Cement Concrete	Nov. 1, 2017	
80359	46	<input type="checkbox"/>	Portland Cement Concrete Bridge Deck Curing	April 1, 2015	Nov. 1, 2017
80401	47	<input type="checkbox"/>	Portland Cement Concrete Pavement Connector for	Aug. 1, 2018	

			Bridge Approach Slab		
80385	48	<input checked="" type="checkbox"/>	Portland Cement Concrete Sidewalk	Aug. 1, 2017	
80300	49	<input type="checkbox"/>	Preformed Plastic Pavement Marking Type D - Inlaid	April 1, 2012	April 1, 2016
80328	50	<input checked="" type="checkbox"/>	Progress Payments	Nov. 2, 2013	
34261	51	<input type="checkbox"/>	Railroad Protective Liability Insurance	Dec. 1, 1986	Jan. 1, 2006
80157	52	<input type="checkbox"/>	Railroad Protective Liability Insurance (5 and 10)	Jan. 1, 2006	
80306	53	<input checked="" type="checkbox"/>	Reclaimed Asphalt Pavement (RAP) and Reclaimed Asphalt Shingles (RAS)	Nov. 1, 2012	Jan. 1, 2018
80395	54	<input type="checkbox"/>	Sloped Metal End Section for Pipe Culverts	Jan. 1, 2018	
80340	55	<input type="checkbox"/>	Speed Display Trailer	April 2, 2014	Jan. 1, 2017
80127	56	<input type="checkbox"/>	Steel Cost Adjustment	April 2, 2004	Aug. 1, 2017
80397	57	<input type="checkbox"/>	Subcontractor and DBE Payment Reporting	April 2, 2018	
80391	58	<input type="checkbox"/>	Subcontractor Mobilization Payments	Nov. 2, 2017	
80317	59	<input type="checkbox"/>	Surface Testing of Hot-Mix Asphalt Overlays	Jan. 1, 2013	April 1, 2016
80298	60	<input type="checkbox"/>	Temporary Pavement Marking (NOTE: This special provision was previously named "Pavement Marking Tape Type IV".)	April 1, 2012	April 1, 2017
20338	61	<input type="checkbox"/>	Training Special Provisions	Oct. 15, 1975	
* 80403	62	<input type="checkbox"/>	Traffic Barrier Terminal, Type 1 Special	Nov. 1, 2018	
80318	63	<input type="checkbox"/>	Traversable Pipe Grate for Concrete End Sections (NOTE: This special provision was previously named "Traversable Pipe Grate".)	Jan. 1, 2013	Jan. 1, 2018
80288	64	<input type="checkbox"/>	Warm Mix Asphalt	Jan. 1, 2012	April 1, 2016
80302	65	<input type="checkbox"/>	Weekly DBE Trucking Reports	June 2, 2012	April 2, 2015
80071	66	<input type="checkbox"/>	Working Days	Jan. 1, 2002	

The following special provisions are in the 2018 Supplemental Specifications and Recurring Special Provisions.

<u>File Name</u>	<u>Special Provision Title</u>	<u>New Location</u>	<u>Effective</u>	<u>Revised</u>
80368	Light Tower	Article 1069.08	July 1, 2016	
80369	Mast Arm Assembly and Pole	Article 1077.03(a)(1)	July 1, 2016	
80338	Portland Cement Concrete Partial Depth Hot-Mix Asphalt Patching	Recurring CS #35	April 1, 2014	April 1, 2016
80379	Steel Plate Beam Guardrail	Articles 630.02, 630.05, 630.06, and 630.08	Jan. 1, 2017	
80381	Traffic Barrier Terminal, Type 1 Special	Article 631.04	Jan. 1, 2017	
80380	Tubular Markers	Articles 701.03, 701.15, 701.18, and 1106.02	Jan. 1, 2017	

The following special provisions require additional information from the designer. The additional information needs to be submitted as a separate document. The Project Development and Implementation section will then include the information in the applicable special provision. The Special Provisions are:

- Bridge Demolition Debris
- Building Removal - Case I
- Building Removal - Case II
- Building Removal - Case III
- Building Removal-Case IV
- Completion Date
- Completion Date Plus Working Days
- DBE Participation
- Material Transfer Device
- Railroad Protective Liability Insurance
- Training Special Provisions
- Working Days

COMPLETION DATE (VIA CALENDAR DAYS) (BDE)

Effective: April 1, 2008

The Contractor shall complete all work on or before the completion date of this contract which will be based upon 120 calendar days.

The completion date will be determined by adding the specified number of calendar days to the date the Contractor begins work, or to the date ten days after execution of the contract, whichever is the earlier, unless a delayed start is granted by the Engineer.

80198

HOT-MIX ASPHALT - DENSITY TESTING OF LONGITUDINAL JOINTS (BDE)

Effective: January 1, 2010

Revised: April 1, 2016

Description. This work shall consist of testing the density of longitudinal joints as part of the quality control/quality assurance (QC/QA) of hot-mix asphalt (HMA). Work shall be according to Section 1030 of the Standard Specifications except as follows.

Quality Control/Quality Assurance (QC/QA). Delete the second and third sentence of the third paragraph of Article 1030.05(d)(3) of the Standard Specifications.

Add the following paragraphs to the end of Article 1030.05(d)(3) of the Standard Specifications:

“Longitudinal joint density testing shall be performed at each random density test location. Longitudinal joint testing shall be located at a distance equal to the lift thickness or a minimum of 4 in. (100 mm), from each pavement edge. (i.e. for a 5 in. (125 mm) lift the near edge of the density gauge or core barrel shall be within 5 in. (125 mm) from the edge of pavement.) Longitudinal joint density testing shall be performed using either a correlated nuclear gauge or cores.

- a. Confined Edge. Each confined edge density shall be represented by a one-minute nuclear density reading or a core density and shall be included in the average of density readings or core densities taken across the mat which represents the Individual Test.
- b. Unconfined Edge. Each unconfined edge joint density shall be represented by an average of three one-minute density readings or a single core density at the given density test location and shall meet the density requirements specified herein. The three one-minute readings shall be spaced 10 ft (3 m) apart longitudinally along the unconfined pavement edge and centered at the random density test location.”

Revise the Density Control Limits table in Article 1030.05(d)(4) of the Standard Specifications to read:

“Mixture Composition	Parameter	Individual Test (includes confined edges)	Unconfined Edge Joint Density Minimum
IL-4.75	Ndesign = 50	93.0 – 97.4% ^{1/}	91.0%
IL-9.5	Ndesign = 90	92.0 – 96.0%	90.0%
IL-9.5,IL-9.5L	Ndesign < 90	92.5 – 97.4%	90.0%
IL-19.0	Ndesign = 90	93.0 – 96.0%	90.0%
IL-19.0, IL-19.0L	Ndesign < 90	93.0 ^{2/} – 97.4%	90.0%
SMA	Ndesign = 50 & 80	93.5 – 97.4%	91.0%”

CONSTRUCTION AIR QUALITY – DIESEL RETROFIT (BDE)

Effective: June 1, 2010

Revised: November 1, 2014

The reduction of emissions of particulate matter (PM) for off-road equipment shall be accomplished by installing retrofit emission control devices. The term “equipment” refers to diesel fuel powered devices rated at 50 hp and above, to be used on the jobsite in excess of seven calendar days over the course of the construction period on the jobsite (including rental equipment).

Contractor and subcontractor diesel powered off-road equipment assigned to the contract shall be retrofitted using the phased in approach shown below. Equipment that is of a model year older than the year given for that equipment’s respective horsepower range shall be retrofitted:

Effective Dates	Horsepower Range	Model Year
June 1, 2010 ^{1/}	600-749	2002
	750 and up	2006
June 1, 2011 ^{2/}	100-299	2003
	300-599	2001
	600-749	2002
	750 and up	2006
June 1, 2012 ^{2/}	50-99	2004
	100-299	2003
	300-599	2001
	600-749	2002
	750 and up	2006

1/ Effective dates apply to Contractor diesel powered off-road equipment assigned to the contract.

2/ Effective dates apply to Contractor and subcontractor diesel powered off-road equipment assigned to the contract.

The retrofit emission control devices shall achieve a minimum PM emission reduction of 50 percent and shall be:

- a) Included on the U.S. Environmental Protection Agency (USEPA) *Verified Retrofit Technology List* (<http://www.epa.gov/cleandiesel/verification/verif-list.htm>), or verified by the California Air Resources Board (CARB) (<http://www.arb.ca.gov/diesel/verdev/vt/cvt.htm>); or
- b) Retrofitted with a non-verified diesel retrofit emission control device if verified retrofit emission control devices are not available for equipment proposed to be used on the project, and if the Contractor has obtained a performance certification from the retrofit

device manufacturer that the emission control device provides a minimum PM emission reduction of 50 percent.

Note: Large cranes (Crawler mounted cranes) which are responsible for critical lift operations are exempt from installing retrofit emission control devices if such devices adversely affect equipment operation.

Diesel powered off-road equipment with engine ratings of 50 hp and above, which are unable to be retrofitted with verified emission control devices or if performance certifications are not available which will achieve a minimum 50 percent PM reduction, may be granted a waiver by the Department if documentation is provided showing good faith efforts were made by the Contractor to retrofit the equipment.

Construction shall not proceed until the Contractor submits a certified list of the diesel powered off-road equipment that will be used, and as necessary, retrofitted with emission control devices. The list(s) shall include (1) the equipment number, type, make, Contractor/rental company name; and (2) the emission control devices make, model, USEPA or CARB verification number, or performance certification from the retrofit device manufacturer. Equipment reported as fitted with emissions control devices shall be made available to the Engineer for visual inspection of the device installation, prior to being used on the jobsite.

The Contractor shall submit an updated list of retrofitted off-road construction equipment as retrofitted equipment changes or comes on to the jobsite. The addition or deletion of any diesel powered equipment shall be included on the updated list.

If any diesel powered off-road equipment is found to be in non-compliance with any portion of this special provision, the Engineer will issue the Contractor a diesel retrofit deficiency deduction.

Any costs associated with retrofitting any diesel powered off-road equipment with emission control devices shall be considered as included in the contract unit prices bid for the various items of work involved and no additional compensation will be allowed. The Contractor's compliance with this notice and any associated regulations shall not be grounds for a claim.

Diesel Retrofit Deficiency Deduction

When the Engineer determines that a diesel retrofit deficiency exists, a daily monetary deduction will be imposed for each calendar day or fraction thereof the deficiency continues to exist. The calendar day(s) will begin when the time period for correction is exceeded and end with the Engineer's written acceptance of the correction. The daily monetary deduction will be \$1,000.00 for each deficiency identified.

The deficiency will be based on lack of diesel retrofit emissions control.

If a Contractor accumulates three diesel retrofit deficiency deductions for the same piece of equipment in a contract period, the Contractor will be shutdown until the deficiency is corrected.

Such a shutdown will not be grounds for any extension of the contract time, waiver of penalties, or be grounds for any claim.

80261

RECLAIMED ASPHALT PAVEMENT AND RECLAIMED ASPHALT SHINGLES (BDE)

Effective: November 1, 2012

Revise: April 1, 2016

Revise Section 1031 of the Standard Specifications to read:

"SECTION 1031. RECLAIMED ASPHALT PAVEMENT AND RECLAIMED ASPHALT SHINGLES

1031.01 Description. Reclaimed asphalt pavement and reclaimed asphalt shingles shall be according to the following.

- (a) Reclaimed Asphalt Pavement (RAP). RAP is the material produced by cold milling or crushing an existing hot-mix asphalt (HMA) pavement. The Contractor shall supply written documentation that the RAP originated from routes or airfields under federal, state, or local agency jurisdiction.
- (b) Reclaimed Asphalt Shingles (RAS). Reclaimed asphalt shingles (RAS). RAS is from the processing and grinding of preconsumer or post-consumer shingles. RAS shall be a clean and uniform material with a maximum of 0.5 percent unacceptable material, as defined in Bureau of Materials and Physical Research Policy Memorandum, "Reclaimed Asphalt Shingle (RAS) Sources", by weight of RAS. All RAS used shall come from a Bureau of Materials and Physical Research approved processing facility where it shall be ground and processed to 100 percent passing the 3/8 in. (9.5 mm) sieve and 93 percent passing the #4 (4.75 mm) sieve based on a dry shake gradation. RAS shall be uniform in gradation and asphalt binder content and shall meet the testing requirements specified herein. In addition, RAS shall meet the following Type 1 or Type 2 requirements.
 - (1) Type 1. Type 1 RAS shall be processed, preconsumer asphalt shingles salvaged from the manufacture of residential asphalt roofing shingles.
 - (2) Type 2. Type 2 RAS shall be processed post-consumer shingles only, salvaged from residential, or four unit or less dwellings not subject to the National Emission Standards for Hazardous Air Pollutants (NESHAP).

1031.02 Stockpiles. RAP and RAS stockpiles shall be according to the following.

- (a) RAP Stockpiles. The Contractor shall construct individual, sealed RAP stockpiles meeting one of the following definitions. No additional RAP shall be added to the pile after the pile has been sealed. Stockpiles shall be sufficiently separated to prevent intermingling at the base. Stockpiles shall be identified by signs indicating the type as listed below (i.e. "Homogeneous Surface").

Prior to milling, the Contractor shall request the District provide documentation on the quality of the RAP to clarify the appropriate stockpile.

- (1) Fractionated RAP (FRAP). FRAP shall consist of RAP from Class I, HMA (High and Low ESAL) mixtures. The coarse aggregate in FRAP shall be crushed aggregate and may represent more than one aggregate type and/or quality, but shall be at least C quality. All FRAP shall be fractionated prior to testing by screening into a minimum of two size fractions with the separation occurring on or between the #4 (4.75 mm) and 1/2 in. (12.5 mm) sieves. Agglomerations shall be minimized such that 100 percent of the RAP shall pass the sieve size specified below for the mix into which the FRAP will be incorporated.

Mixture FRAP will be used in:	Sieve Size that 100 % of FRAP Shall Pass
IL-19.0	1 1/2 in. (40 mm)
IL-9.5	3/4 in. (20 mm)
IL-4.75	1/2 in. (13 mm)

- (2) Homogeneous. Homogeneous RAP stockpiles shall consist of RAP from Class I, HMA (High and Low ESAL) mixtures and represent: 1) the same aggregate quality, but shall be at least C quality; 2) the same type of crushed aggregate (either crushed natural aggregate, ACBF slag, or steel slag); 3) similar gradation; and 4) similar asphalt binder content. If approved by the Engineer, combined single pass surface/binder millings may be considered "homogeneous" with a quality rating dictated by the lowest coarse aggregate quality present in the mixture.
- (3) Conglomerate. Conglomerate RAP stockpiles shall consist of RAP from Class I, HMA (High and Low ESAL) mixtures. The coarse aggregate in this RAP shall be crushed aggregate and may represent more than one aggregate type and/or quality, but shall be at least C quality. This RAP may have an inconsistent gradation and/or asphalt binder content prior to processing. All conglomerate RAP shall be processed prior to testing by crushing to where all RAP shall pass the 5/8 in. (16 mm) or smaller screen. Conglomerate RAP stockpiles shall not contain steel slag.
- (4) Non-Quality. RAP stockpiles that do not meet the requirements of the stockpile categories listed above shall be classified as "Non-Quality".

RAP/FRAP containing contaminants, such as earth, brick, sand, concrete, sheet asphalt, bituminous surface treatment (i.e. chip seal), pavement fabric, joint sealants, etc., will be unacceptable unless the contaminants are removed to the satisfaction of the Engineer. Sheet asphalt shall be stockpiled separately.

- (b) RAS Stockpiles. Type 1 and Type 2 RAS shall be stockpiled separately and shall not be intermingled. Each stockpile shall be signed indicating what type of RAS is present.

Unless otherwise specified by the Engineer, mechanically blending manufactured sand (FM 20 or FM 22) up to an equal weight of RAS with the processed RAS will be permitted to improve workability. The sand shall be "B Quality" or better from an approved Aggregate Gradation Control System source. The sand shall be accounted for in the mix design and during HMA production.

Records identifying the shingle processing facility supplying the RAS, RAS type, and lot number shall be maintained by project contract number and kept for a minimum of three years.

1031.03 Testing. RAP/FRAP and RAS testing shall be according to the following.

(a) RAP/FRAP Testing. When used in HMA, the RAP/FRAP shall be sampled and tested either during or after stockpiling.

(1) During Stockpiling. For testing during stockpiling, washed extraction samples shall be run at the minimum frequency of one sample per 500 tons (450 metric tons) for the first 2000 tons (1800 metric tons) and one sample per 2000 tons (1800 metric tons) thereafter. A minimum of five tests shall be required for stockpiles less than 4000 tons (3600 metric tons).

(2) After Stockpiling. For testing after stockpiling, the Contractor shall submit a plan for approval to the District proposing a satisfactory method of sampling and testing the RAP/FRAP pile either in-situ or by restockpiling. The sampling plan shall meet the minimum frequency required above and detail the procedure used to obtain representative samples throughout the pile for testing.

Each sample shall be split to obtain two equal samples of test sample size. One of the two test samples from the final split shall be labeled and stored for Department use. The Contractor shall extract the other test sample according to Department procedure. The Engineer reserves the right to test any sample (split or Department-taken) to verify Contractor test results.

(b) RAS Testing. RAS or RAS blended with manufactured sand shall be sampled and tested during stockpiling according to Bureau of Materials and Physical Research Policy Memorandum, "Reclaimed Asphalt Shingle (RAS) Source".

Samples shall be collected during stockpiling at the minimum frequency of one sample per 200 tons (180 metric tons) for the first 1000 tons (900 metric tons) and one sample per 250 tons (225 metric tons) thereafter. A minimum of five samples are required for stockpiles less than 1000 tons (900 metric tons). Once a ≤ 1000 ton (900 metric ton), five-sample/test stockpile has been established it shall be sealed. Additional incoming RAS or RAS blended with manufactured sand shall be stockpiled in a separate working pile as designated in the Quality Control plan and only added to the sealed stockpile when the test results of the working pile are complete and are found to meet the tolerances specified herein for the original sealed RAS stockpile.

Before testing, each sample shall be split to obtain two test samples. One of the two test samples from the final split shall be labeled and stored for Department use. The Contractor shall perform a washed extraction and test for unacceptable materials on the other test sample according to Department procedures. The Engineer reserves the right to test any sample (split or Department-taken) to verify Contractor test results.

If the sampling and testing was performed at the shingle processing facility in accordance with the QC Plan, the Contractor shall obtain and make available all of the test results from start of the initial stockpile.

1031.04 Evaluation of Tests. Evaluation of test results shall be according to the following.

- (a) Evaluation of RAP/FRAP Test Results. All of the extraction results shall be compiled and averaged for asphalt binder content and gradation, and when applicable G_{mm} . Individual extraction test results, when compared to the averages, will be accepted if within the tolerances listed below.

Parameter	FRAP/Homogeneous/ Conglomerate
1 in. (25 mm)	
1/2 in. (12.5 mm)	± 8 %
No. 4 (4.75 mm)	± 6 %
No. 8 (2.36 mm)	± 5 %
No. 16 (1.18 mm)	
No. 30 (600 µm)	± 5 %
No. 200 (75 µm)	± 2.0 %
Asphalt Binder	± 0.4 % ^{1/}
G_{mm}	± 0.03

1/ The tolerance for FRAP shall be ± 0.3 %.

If more than 20 percent of the individual sieves and/or asphalt binder content tests are out of the above tolerances, the RAP/FRAP shall not be used in HMA unless the RAP/FRAP representing the failing tests is removed from the stockpile. All test data and acceptance ranges shall be sent to the District for evaluation.

With the approval of the Engineer, the ignition oven may be substituted for extractions according to the ITP, "Calibration of the Ignition Oven for the Purpose of Characterizing Reclaimed Asphalt Pavement (RAP)".

- (b) Evaluation of RAS and RAS Blended with Manufactured Sand Test Results. All of the test results, with the exception of percent unacceptable materials, shall be compiled and averaged for asphalt binder content and gradation. Individual test results, when compared to the averages, will be accepted if within the tolerances listed below.

Parameter	RAS
No. 8 (2.36 mm)	± 5 %
No. 16 (1.18 mm)	± 5 %
No. 30 (600 µm)	± 4 %
No. 200 (75 µm)	± 2.0 %
Asphalt Binder Content	± 1.5 %

If more than 20 percent of the individual sieves and/or asphalt binder content tests are out of the above tolerances, or if the percent unacceptable material exceeds 0.5 percent by weight of material retained on the # 4 (4.75 mm) sieve, the RAS or RAS blend shall not be used in Department projects. All test data and acceptance ranges shall be sent to the District for evaluation.

1031.05 Quality Designation of Aggregate in RAP/FRAP.

(a) RAP. The aggregate quality of the RAP for homogeneous and conglomerate stockpiles shall be set by the lowest quality of coarse aggregate in the RAP stockpile and are designated as follows.

(1) RAP from Class I, Superpave/HMA (High ESAL), or (Low ESAL) IL-9.5L surface mixtures are designated as containing Class B quality coarse aggregate.

(2) RAP from Class I binder, Superpave/HMA (High ESAL) binder, or (Low ESAL) IL-19.0L binder mixtures are designated as containing Class C quality coarse aggregate.

(b) FRAP. If the Engineer has documentation of the quality of the FRAP aggregate, the Contractor shall use the assigned quality provided by the Engineer.

If the quality is not known, the quality shall be determined as follows. Coarse and fine FRAP stockpiles containing plus #4 (4.75 mm) sieve coarse aggregate shall have a maximum tonnage of 5000 tons (4500 metric tons). The Contractor shall obtain a representative sample witnessed by the Engineer. The sample shall be a minimum of 50 lb (25 kg). The sample shall be extracted according to Illinois Modified AASHTO T 164 by a consultant laboratory prequalified by the Department for the specified testing. The consultant laboratory shall submit the test results along with the recovered aggregate to the District Office. The cost for this testing shall be paid by the Contractor. The District will forward the sample to the Bureau of Materials and Physical Research Aggregate Lab for MicroDeval Testing, according to ITP 327. A maximum loss of 15.0 percent will be applied for all HMA applications.

1031.06 Use of RAP/FRAP and/or RAS in HMA. The use of RAP/FRAP and/or RAS shall be the Contractor's option when constructing HMA in all contracts.

(a) RAP/FRAP. The use of RAP/FRAP in HMA shall be as follows.

- (1) Coarse Aggregate Size. The coarse aggregate in all RAP shall be equal to or less than the nominal maximum size requirement for the HMA mixture to be produced.
 - (2) Steel Slag Stockpiles. Homogeneous RAP stockpiles containing steel slag will be approved for use in all HMA (High ESAL and Low ESAL) Surface and Binder Mixture applications.
 - (3) Use in HMA Surface Mixtures (High and Low ESAL). RAP/FRAP stockpiles for use in HMA surface mixtures (High and Low ESAL) shall be FRAP or homogeneous in which the coarse aggregate is Class B quality or better. RAP/FRAP from Conglomerate stockpiles shall be considered equivalent to limestone for frictional considerations. Known frictional contributions from plus #4 (4.75 mm) homogeneous RAP and FRAP stockpiles will be accounted for in meeting frictional requirements in the specified mixture.
 - (4) Use in HMA Binder Mixtures (High and Low ESAL), HMA Base Course, and HMA Base Course Widening. RAP/FRAP stockpiles for use in HMA binder mixtures (High and Low ESAL), HMA base course, and HMA base course widening shall be FRAP, homogeneous, or conglomerate, in which the coarse aggregate is Class C quality or better.
 - (5) Use in Shoulders and Subbase. RAP/FRAP stockpiles for use in HMA shoulders and stabilized subbase (HMA) shall be FRAP, homogeneous, or conglomerate.
 - (6) When the Contractor chooses the RAP option, the percentage of RAP shall not exceed the amounts indicated in Article 1031.06(c)(1) below for a given Ndesign.
- (b) RAS. RAS meeting Type 1 or Type 2 requirements will be permitted in all HMA applications as specified herein.
- (c) RAP/FRAP and/or RAS Usage Limits. Type 1 or Type 2 RAS may be used alone or in conjunction with RAP or FRAP in HMA mixtures up to a maximum of 5.0 percent by weight of the total mix.
- (1) RAP/RAS. When RAP is used alone or RAP is used in conjunction with RAS, the percentage of virgin asphalt binder replacement shall not exceed the amounts listed in the Max RAP/RAS ABR table listed below for the given Ndesign.

RAP/RAS Maximum Asphalt Binder Replacement (ABR) Percentage

HMA Mixtures <i>1/, 2/</i>	RAP/RAS Maximum ABR %		
	Binder/Leveling Binder	Surface	Polymer Modified
30	30	30	10

50	25	15	10
70	15	10	10
90	10	10	10

1/ For Low ESAL HMA shoulder and stabilized subbase, the RAP/RAS ABR shall not exceed 50 percent of the mixture.

2/ When RAP/RAS ABR exceeds 20 percent, the high and low virgin asphalt binder grades shall each be reduced by one grade (i.e. 25 percent ABR would require a virgin asphalt binder grade of PG 64-22 to be reduced to a PG 58-28). If warm mix asphalt (WMA) technology is utilized and production temperatures do not exceed 275 °F (135 °C), the high and low virgin asphalt binder grades shall each be reduced by one grade when RAP/RAS ABR exceeds 25 percent (i.e. 26 percent RAP/RAS ABR would require a virgin asphalt binder grade of PG 64-22 to be reduced to a PG 58-28).

(2) FRAP/RAS. When FRAP is used alone or FRAP is used in conjunction with RAS, the percentage of virgin asphalt binder replacement shall not exceed the amounts listed in the FRAP/RAS table listed below for the given Ndesign.

FRAP/RAS Maximum Asphalt Binder Replacement (ABR) Percentage

HMA Mixtures <i>1, 2/</i>	FRAP/RAS Maximum ABR %		
	Ndesign	Binder/Leveling Binder	Surface
30	50	40	10
50	40	35	10
70	40	30	10
90	40	30	10

1/ For Low ESAL HMA shoulder and stabilized subbase, the FRAP/RAS ABR shall not exceed 50 percent of the mixture.

2/ When FRAP/RAS ABR exceeds 20 percent for all mixes, the high and low virgin asphalt binder grades shall each be reduced by one grade (i.e. 25 percent ABR would require a virgin asphalt binder grade of PG 64-22 to be reduced to a PG 58-28). If warm mix asphalt (WMA) technology is utilized and production temperatures do not exceed 275 °F (135 °C), the high and low virgin asphalt binder grades shall each be reduced by one grade when FRAP/RAS ABR exceeds 25 percent (i.e. 26 percent ABR would require a virgin asphalt binder grade of PG 64-22 to be reduced to a PG 58-28).

3/ For SMA the FRAP/RAS ABR shall not exceed 20 percent.

4/ For IL-4.75 mix the FRAP/RAS ABR shall not exceed 30 percent.

1031.07 HMA Mix Designs. At the Contractor's option, HMA mixtures may be constructed utilizing RAP/FRAP and/or RAS material meeting the detailed requirements specified herein.

- (a) RAP/FRAP and/or RAS. RAP/FRAP and/or RAS mix designs shall be submitted for verification. If additional RAP/FRAP and/or RAS stockpiles are tested and found that no more than 20 percent of the results, as defined under "Testing" herein, are outside of the control tolerances set for the original RAP/FRAP and/or RAS stockpile and HMA mix design, and meets all of the requirements herein, the additional RAP/FRAP and/or RAS stockpiles may be used in the original mix design at the percent previously verified.
- (b) RAS. Type 1 and Type 2 RAS are not interchangeable in a mix design. A RAS stone bulk specific gravity (Gsb) of 2.300 shall be used for mix design purposes.

1031.08 HMA Production. HMA production utilizing RAP/FRAP and/or RAS shall be as follows.

- (a) RAP/FRAP. The coarse aggregate in all RAP/FRAP used shall be equal to or less than the nominal maximum size requirement for the HMA mixture being produced.

To remove or reduce agglomerated material, a scalping screen, gator, crushing unit, or comparable sizing device approved by the Engineer shall be used in the RAP feed system to remove or reduce oversized material. If material passing the sizing device adversely affects the mix production or quality of the mix, the sizing device shall be set at a size specified by the Engineer.

If the RAP/FRAP control tolerances or QC/QA test results require corrective action, the Contractor shall cease production of the mixture containing RAP/FRAP and either switch to the virgin aggregate design or submit a new RAP/FRAP design.

- (b) RAS. RAS shall be incorporated into the HMA mixture either by a separate weight depletion system or by using the RAP weigh belt. Either feed system shall be interlocked with the aggregate feed or weigh system to maintain correct proportions for all rates of production and batch sizes. The portion of RAS shall be controlled accurately to within ± 0.5 percent of the amount of RAS utilized. When using the weight depletion system, flow indicators or sensing devices shall be provided and interlocked with the plant controls such that the mixture production is halted when RAS flow is interrupted.
- (c) RAP/FRAP and/or RAS. HMA plants utilizing RAP/FRAP and/or RAS shall be capable of automatically recording and printing the following information.

(1) Dryer Drum Plants.

- a. Date, month, year, and time to the nearest minute for each print.

- b. HMA mix number assigned by the Department.
- c. Accumulated weight of dry aggregate (combined or individual) in tons (metric tons) to the nearest 0.1 ton (0.1 metric ton).
- d. Accumulated dry weight of RAP/FRAP/RAS in tons (metric tons) to the nearest 0.1 ton (0.1 metric ton).
- e. Accumulated mineral filler in revolutions, tons (metric tons), etc. to the nearest 0.1 unit.
- f. Accumulated asphalt binder in gallons (liters), tons (metric tons), etc. to the nearest 0.1 unit.
- g. Residual asphalt binder in the RAP/FRAP material as a percent of the total mix to the nearest 0.1 percent.
- h. Aggregate and RAP/FRAP moisture compensators in percent as set on the control panel. (Required when accumulated or individual aggregate and RAP/FRAP are printed in wet condition.)

(2) Batch Plants.

- a. Date, month, year, and time to the nearest minute for each print.
- b. HMA mix number assigned by the Department.
- c. Individual virgin aggregate hot bin batch weights to the nearest pound (kilogram).
- d. Mineral filler weight to the nearest pound (kilogram).
- e. RAP/FRAP/RAS weight to the nearest pound (kilogram).
- f. Virgin asphalt binder weight to the nearest pound (kilogram).
- g. Residual asphalt binder in the RAP/FRAP/RAS material as a percent of the total mix to the nearest 0.1 percent.

The printouts shall be maintained in a file at the plant for a minimum of one year or as directed by the Engineer and shall be made available upon request. The printing system will be inspected by the Engineer prior to production and verified at the beginning of each construction season thereafter.

1031.09 RAP in Aggregate Surface Course and Aggregate Wedge Shoulders, Type B.

The use of RAP in aggregate surface course (temporary access entrances only) and aggregate wedge shoulders, Type B shall be as follows.

- (a) Stockpiles and Testing. RAP stockpiles may be any of those listed in Article 1031.02, except "Non-Quality" and "FRAP". The testing requirements of Article 1031.03 shall not apply. RAP used shall be according to the current Bureau of Materials and Physical Research Policy Memorandum, "Reclaimed Asphalt Pavement (RAP) for Aggregate Applications".
- (b) Gradation. One hundred percent of the RAP material shall pass the 1 1/2 in. (37.5 mm) sieve. The RAP material shall be reasonably well graded from coarse to fine. RAP material that is gap-graded or single sized will not be accepted."

80306

PROGRESS PAYMENTS (BDE)

Effective: November 2, 2013

Revise Article 109.07(a) of the Standard Specifications to read:

“(a) Progress Payments. At least once each month, the Engineer will make a written estimate of the quantity of work performed in accordance with the contract, and the value thereof at the contract unit prices. The amount of the estimate approved as due for payment will be vouchered by the Department and presented to the State Comptroller for payment. No amount less than \$1000.00 will be approved for payment other than the final payment.

Progress payments may be reduced by liens filed pursuant to Section 23(c) of the Mechanics' Lien Act, 770 ILCS 60/23(c).

If a Contractor or subcontractor has defaulted on a loan issued under the Department's Disadvantaged Business Revolving Loan Program (20 ILCS 2705/2705-610), progress payments may be reduced pursuant to the terms of that loan agreement. In such cases, the amount of the estimate related to the work performed by the Contractor or subcontractor, in default of the loan agreement, will be offset, in whole or in part, and vouchered by the Department to the Working Capital Revolving Fund or designated escrow account. Payment for the work shall be considered as issued and received by the Contractor or subcontractor on the date of the offset voucher. Further, the amount of the offset voucher shall be a credit against the Department's obligation to pay the Contractor, the Contractor's obligation to pay the subcontractor, and the Contractor's or subcontractor's total loan indebtedness to the Department. The offset shall continue until such time as the entire loan indebtedness is satisfied. The Department will notify the Contractor and Fund Control Agent in a timely manner of such offset. The Contractor or subcontractor shall not be entitled to additional payment in consideration of the offset.

The failure to perform any requirement, obligation, or term of the contract by the Contractor shall be reason for withholding any progress payments until the Department determines that compliance has been achieved.”

ADJUSTING FRAMES AND GRATES (BDE)

Effective: April 1, 2017

Add the following to Article 602.02 of the Standard Specifications:

- “(s) High Density Expanded Polystyrene Adjusting Rings
with Polyurea Coating (Note 4) 1043.04
- (t) Expanded Polypropylene (EPP) Adjusting Rings (Note 5) 1043.05

Note 4. High density expanded polystyrene adjusting rings with polyurea coating shall meet the design load requirements of AASHTO HS20/25. The rings may be used to adjust the frames and grates of drainage and utility structures up to a maximum of 6 in. (150 mm). They shall be installed and sealed underneath the frames according to the manufacturer’s specifications.

Note 5. Riser rings fabricated from EPP may be used to adjust the frames and grates of drainage and utility structures up to a maximum of 6 in. (150 mm). An adhesive meeting ASTM C 920, Type S, Grade N5, Class 25 shall be used with EPP adjustment rings. The top ring of the adjustment stack shall be a finish ring with grooves on the lower surface and flat upper surface. The joints between all manhole adjustment rings and the frame and cover shall be sealed using the approved adhesive. In lieu of the use of an adhesive, an internal or external mechanical frame-chimney seal may be used for watertight installation. EPP adjustment rings shall not be used with heat shrinkable infiltration barriers.”

Add the following to Section 1043 of the Standard Specifications:

“1043.04 High Density Expanded Polystyrene Adjusting Rings with Polyurea Coating. High density expanded polystyrene adjustment rings with polyurea coating shall be designed and tested to meet or exceed an HS25 wheel load according to the AASHTO Standard Specifications for Highway Bridges (AASHTO M306 HS-25). The raw material suppliers shall provide certifications of quality or testing using the following ASTM standards, and upon request, certify that only virgin material was used in the manufacturing of the expanded polystyrene rings.

Physical Property	Test Standard	Value	
		3.0 lb/cu ft	4.5 lb/cu ft
Compression Resistance at 10% deformation	ASTM D 1621	50 - 70	70 - 90
at 5% deformation		45 - 60	60 - 80
at 2% deformation		15 - 20	20 - 40
Flexural Strength	ASTM D 790	90 - 120	130 - 200
Water Absorption	ASTM D 570	2.0%	1.7%
Coefficient of Linear Expansion	ASTM D 696	2.70E-06 in./in./°F	2.80E-06 in./in./°F
Sheer Strength	ASTM D 732	55	80

Tensile Strength	ASTM D 1623	70 - 90	130 - 140
Water Vapor Transmission	ASTM C 355	0.82 – 0.86 perm – in.	

High density expanded polystyrene adjustment rings with polyurea coating shall have no void areas, cracks, or tears. The actual diameter or length shall not vary more than 0.125 in. (3 mm) from the specified diameter or length. Variations in height are limited to ± 0.063 in. (± 1.6 mm). Variations shall not exceed 0.25 in. (6 mm) from flat (dish, bow, or convoluting edge) or 0.125 in. (3 mm) for bulges or dips in the surface.

1043.05 Expanded Polypropylene (EPP) Adjusting Rings. The EPP adjusting rings shall be manufactured using a high compression molding process to produce a minimum finished density of 7.5 lb/cu ft (120 g/l). The EPP rings shall be made of materials meeting ASTM D 3575 and ASTM D 4819-13. The grade adjustments shall be designed and tested according to the AASHTO Standard Specifications for Highway Bridges (AASHTO M 306 HS-25).

Grade rings shall contain upper and lower keyways (tongue and groove) for proper vertical alignment and sealing. The top ring, for use directly beneath the cast iron frame, shall have keyways (grooves) on the lower surface with a flat upper surface.

Adhesive or sealant used for watertight installation of the manhole grade adjustment rings shall meet ASTM C 920, Type S, Grade NS, Class 25, Uses NT, T, M, G, A, and O.

EPP adjustment rings shall have no void areas, cracks, or tears. The actual diameter or length shall not vary more than 0.125 in. (3 mm) from the specified diameter or length. Variations in height are limited to ± 0.063 in. (± 1.6 mm). Variations shall not exceed 0.25 in. (6 mm) from flat (dish, bow, or convoluting edge) or 0.125 in. (3 mm) for bulges or dips in the surface."

80382

State of Illinois
Department of Transportation
Bureau of Local Roads and Streets

SPECIAL PROVISION
FOR
INSURANCE

Effective: February 1, 2007
Revised: August 1, 2007

All references to Sections or Articles in this specification shall be construed to mean specific Section or Article of the Standard Specifications for Road and Bridge Construction, adopted by the Department of Transportation.

The Contractor shall name the following entities as additional insured under the Contractor's general liability insurance policy in accordance with Article 107.27:

Village of Villa Park

School District 45

The entities listed above and their officers, employees, and agents shall be indemnified and held harmless in accordance with Article 107.26.

State of Illinois
DEPARTMENT OF TRANSPORTATION
Bureau of Local Roads & StreetsSPECIAL PROVISION
FOR
WAGES OF EMPLOYEES ON PUBLIC WORKSEffective: January 1, 1999
Revised: January 1, 2012

1. Prevailing Wages. All wages paid by the Contractor and each subcontractor shall be in compliance with The Prevailing Wage Act (820 ILCS 130), as amended, except where a prevailing wage violates a federal law, order, or ruling, the rate conforming to the federal law, order, or ruling shall govern. The Contractor shall be responsible to notify each subcontractor of the wage rates set forth in this contract and any revisions thereto. If the Department of Labor revises the wage rates, the revised rate as provided by the public body shall apply to this contract and the Contractor will not be allowed additional compensation on account of said revisions.
2. Payroll Records. The Contractor and each subcontractor shall make and keep, for a period of not less than three years from the date of the last payment on a contract or subcontract, records of all laborers, mechanics, and other workers employed by them on the project; the records shall include each worker's name, address, telephone number when available, social security number, classification or classifications, the hourly wages paid in each pay period, the number of hours worked each day, and the starting and ending times of work each day. Upon seven business days' notice, the Contractor and each subcontractor shall make available for inspection and copying at a location within this State during reasonable hours, the payroll records to the public body in charge of the project, its officers and agents, the Director of Labor and his deputies and agents, and to federal, State, or local law enforcement agencies and prosecutors.
3. Submission of Payroll Records. The Contractor and each subcontractor shall no later than the tenth day of each calendar month file a certified payroll for the immediately preceding month with the public body in charge of the project, except that the full social security number and home address shall not be included on weekly transmittals. Instead the payrolls shall include an identification number for each employee (e.g., the last four digits of the employee's social security number). The certified payroll shall consist of a complete copy of the payroll records except starting and ending times of work each day may be omitted

The certified payroll shall be accompanied by a statement signed by the Contractor or subcontractor or an officer, employee, or agent of the contractor or subcontractor which avers that: (i) he or she has examined the certified payroll records required to be submitted by the Act and such records are true and accurate; (ii) the hourly rate paid to each worker is not less than the general prevailing rate of hourly wages required; and (iii) the Contractor or subcontractor is aware that filing a certified payroll that he or she knows to be false is a Class A misdemeanor.
4. Employees Interviews. The Contractor and each subcontractor shall permit his/her employees to be interviewed on the job, during working hours, by compliance investigators of the Department or the Department of Labor.

State of Illinois
Department of Transportation
Bureau of Local Roads and Streets

SPECIAL PROVISION
FOR
EQUIPMENT RENTAL RATES

Effective: January 1, 2012

All references to Sections or Articles in this specification shall be construed to mean a specific Section or Article of the Standard Specifications for Road and Bridge Construction, adopted by the Department of Transportation.

Replace Article 109.04(b)(4) with the following:

- "(4) Equipment. For any machinery or special equipment (other than small tools) the use of which has been authorized by the Engineer, the Contractor will be paid according to the latest revision of "SCHEDULE OF AVERAGE ANNUAL EQUIPMENT OWNERSHIP EXPENSE" and latest index factor as issued by the Illinois Department of Transportation. The equipment should be of a type and size reasonably required to complete the extra work."

PEDESTRIAN TRUSS SUPERSTRUCTURE

Effective: January 13, 1998

Revised: December 29, 2014

Description: This work shall consist of the design, fabrication, storage, delivery and erection of a welded steel, pedestrian truss superstructure. Also included in this work shall be the furnishing and installation of a deck, all bearings, anchors and/or retainers, railings, fencing and miscellaneous items as indicated on the plans.

Materials:

Truss. Structural steel shall conform to the requirements of Section 1006 of the Standard Specifications, ASTM A847 for cold formed welded square and rectangular tubing, AASHTO M270 Grade 50W (M270M 345W) for atmospheric corrosion resistant structural steel, as applicable, unless otherwise shown on the plans or approved by the Engineer. All structural steel field connections shall be bolted with high strength bolts. High strength bolts for unpainted weathering steel shall conform to ASTM A325 (A325M) (Type 3). For painted structures, the high strength bolts shall be mechanically galvanized according to the requirements of Article 1006.08(a) of the Standard Specifications.

Deck. The deck type shall be as specified on the plans. The materials shall comply with the applicable portions of the materials section of the Standard Specifications.

When specified for use, the concrete deck and stay-in-place forms shall be non composite. Metal Forms shall have a minimum thickness of 0.0359 in. (912 microns) or 20 Gage and shall be galvanized per ASTM A653 (A653M) with a G165 (Z350) min. coating designation.

Railing. The railing shall consist of a smooth rub rail, a toe plate and misc. elements, all located on the inside face of the truss.

Bearings. The bearing shall be designed and furnished as detailed in the plans, in the absence of details, the bearings details shall be as specified by the bridge manufacturer.

When specified for use, elastomeric bearings shall be according to Article 1083 of the Standard Specifications. Teflon surfaces shall be per Article 1083.02(b) of the Standard Specification and shall be bonded to the bearing plate.

Suppliers. The Department maintains a pre-qualified list of proprietary structural systems allowed for pedestrian truss superstructures. This list can be found on the Departments web site under Prequalified Structural Systems. The Contractor's options are limited to those systems pre-qualified by the Department. These systems have been reviewed for structural feasibility and adequacy only. Presence on this list shall in no case relieve the Contractor of the site specific design or QC/QA requirements stated herein.

The manufacturer shall provide evidence of current certification by AISC according to Article 106.08(b) of the Standard Specifications.

Design: The superstructure shall conform to the clear span, clear width, and railing configuration shown on the contract plans. The design shall be according to the LRFD Guide Specifications for the Design of Pedestrian Bridges. The design loads shall be as specified by the Guide Specification except as follows:

Design Wind Loads (P_z) for Pedestrian Trusses in Illinois		
Application	psf (kPa)	Applied to:
Circular Members	35 (1.68)	Projected vertical area of member
Flat Members	55 (2.63)	Projected vertical area of member
Signs	35 (1.68)	Projected vertical area of sign
Chain Link Fencing	10 (0.48)	Full projected area of fencing as if solid

The railings shall be designed per the appropriate Bridge Design Specifications for bicycle railings as shown on the plans. Smooth rub rails shall be attached to the bicycle railing and located at a bicycle handlebar height of 3.5 ft. (1.1 m) above the top of the deck.

Prior to beginning construction or fabrication, the Contractor shall submit design calculations and six sets of shop drawings for each pedestrian bridge to the Engineer for review and approval. In addition, for bridges with any span over 150 ft. (46 m), or over a State or Federal Route, or within the States Right-of-Way, a copy of the shop drawings will be reviewed and approved for structural adequacy, by the Bureau of Bridges and Structures prior to final approval of shop drawings. The shop drawings shall include all support reactions for each load type. The following certification shall be placed on the first sheet of the bridge shop plans adjacent to the seal and signature of the Structural Engineer:

“I certify that to the best of my knowledge, information and belief, this bridge design is structurally adequate for the design loading shown on the plans and complies with the requirements of the Contract and the current ‘Guide Specifications for Design of Pedestrian Bridges’.”

The substructure is designed per the appropriate Bridge Design Specifications and based on the assumed truss loads, as shown on the plans. If the manufacturer’s design exceeds those loads and/or the substructure needs to be adjusted to accommodate the truss superstructure chosen, then the Contractor shall submit the redesign to the Engineer for approval prior to ordering any material or starting construction. All design calculations, shop drawings and redesigned substructure drawings shall be sealed by a Structural Engineer licensed in the State of Illinois.

Construction: Truss erection procedures shall be according to the manufacturer’s instructions. The deck shall be placed according to the applicable Sections of the Standard Specifications.

When weathering steel is used, all structural steel shall be prepared according to Article 506.07.

When painting is specified, all structural steel shall be cleaned and painted according to Section 506. The paint system and color of the finish coat shall be as specified in the plans.

Method of Measurement: The pedestrian truss superstructure will be measured in square feet (square meters) of completed and accepted structure measured horizontally from back to back of abutments and within the clear path width as defined on the plans.

Basis of Payment: The pedestrian superstructure will be paid for at the contract unit price per square foot (square meter) for "PEDESTRIAN TRUSS SUPERSTRUCTURE."

PORTLAND CEMENT CONCRETE (BDE)

Effective: November 1, 2017

Revise the Air Content % of Class PP Concrete in Table 1 Classes of Concrete and Mix Design Criteria in Article 1020.04 of the Standard Specifications to read:

"TABLE 1. CLASSES OF CONCRETE AND MIX DESIGN CRITERIA		
Class of Conc.	Use	Air Content %
PP	Pavement Patching Bridge Deck Patching (10)	4.0 - 8.0"
	PP-1	
	PP-2	
	PP-3	
	PP-4	
	PP-5	

Revise Note (4) at the end of Table 1 Classes of Concrete and Mix Design Criteria in Article 1020.04 of the Standard Specifications to read:

"(4) For all classes of concrete, the maximum slump may be increased to 7 in (175 mm) when a high range water-reducing admixture is used. For Class SC, the maximum slump may be increased to 8 in. (200 mm). For Class PS, the maximum slump may be increased to 8 1/2 in. (215 mm) if the high range water-reducing admixture is the polycarboxylate type."

HOT-MIX ASPHALT – TACK COAT (BDE)

Effective: November 1, 2016

Revise Article 1032.06(a) of the Standard Specifications to read:

“(a) Anionic Emulsified Asphalt. Anionic emulsified asphalts shall be according to AASHTO M 140. SS-1h emulsions used as a tack coat shall have the cement mixing test waived.”

80376

COMPENSABLE DELAY COSTS (BDE)

Effective: June 2, 2017

Revise Article 107.40(b) of the Standard Specifications to read:

“(b) Compensation. Compensation will not be allowed for delays, inconveniences, or damages sustained by the Contractor from conflicts with facilities not meeting the above definition; or if a conflict with a utility in an unanticipated location does not cause a shutdown of the work or a documentable reduction in the rate of progress exceeding the limits set herein. The provisions of Article 104.03 notwithstanding, compensation for delays caused by a utility in an unanticipated location will be paid according to the provisions of this Article governing minor and major delays or reduced rate of production which are defined as follows.

- (1) Minor Delay. A minor delay occurs when the work in conflict with the utility in an unanticipated location is completely stopped for more than two hours, but not to exceed two weeks.
- (2) Major Delay. A major delay occurs when the work in conflict with the utility in an unanticipated location is completely stopped for more than two weeks.
- (3) Reduced Rate of Production Delay. A reduced rate of production delay occurs when the rate of production on the work in conflict with the utility in an unanticipated location decreases by more than 25 percent and lasts longer than seven calendar days.”

Revise Article 107.40(c) of the Standard Specifications to read:

“(c) Payment. Payment for Minor, Major, and Reduced Rate of Production Delays will be made as follows.

- (1) Minor Delay. Labor idled which cannot be used on other work will be paid for according to Article 109.04(b)(1) and (2) for the time between start of the delay and the minimum remaining hours in the work shift required by the prevailing practice in the area.

Equipment idled which cannot be used on other work, and which is authorized to standby on the project site by the Engineer, will be paid for according to Article 109.04(b)(4).

- (2) Major Delay. Labor will be the same as for a minor delay.

Equipment will be the same as for a minor delay, except Contractor-owned equipment will be limited to two weeks plus the cost of move-out to either the Contractor's yard or another job and the cost to re-mobilize, whichever is less.

Rental equipment may be paid for longer than two weeks provided the Contractor presents adequate support to the Department (including lease agreement) to show retaining equipment on the job is the most economical course to follow and in the public interest.

- (3) Reduced Rate of Production Delay. The Contractor will be compensated for the reduced productivity for labor and equipment time in excess of the 25 percent threshold for that portion of the delay in excess of seven calendar days. Determination of compensation will be in accordance with Article 104.02, except labor and material additives will not be permitted.

Payment for escalated material costs, escalated labor costs, extended project overhead, and extended traffic control will be determined according to Article 109.13.”

Revise Article 108.04(b) of the Standard Specifications to read:

“(b) No working day will be charged under the following conditions.

- (1) When adverse weather prevents work on the controlling item.
- (2) When job conditions due to recent weather prevent work on the controlling item.
- (3) When conduct or lack of conduct by the Department or its consultants, representatives, officers, agents, or employees; delay by the Department in making the site available; or delay in furnishing any items required to be furnished to the Contractor by the Department prevents work on the controlling item.
- (4) When delays caused by utility or railroad adjustments prevent work on the controlling item.
- (5) When strikes, lock-outs, extraordinary delays in transportation, or inability to procure critical materials prevent work on the controlling item, as long as these delays are not due to any fault of the Contractor.
- (6) When any condition over which the Contractor has no control prevents work on the controlling item.”

Revise Article 109.09(f) of the Standard Specifications to read:

- “(f) Basis of Payment. After resolution of a claim in favor of the Contractor, any adjustment in time required for the work will be made according to Section 108. Any adjustment in the costs to be paid will be made for direct labor, direct materials, direct equipment, direct jobsite overhead, direct offsite overhead, and other direct costs allowed by the resolution. Adjustments in costs will not be made for interest charges, loss of anticipated profit, undocumented loss of efficiency, home office overhead and unabsorbed overhead

other than as allowed by Article 109.13, lost opportunity, preparation of claim expenses and other consequential indirect costs regardless of method of calculation.

The above Basis of Payment is an essential element of the contract and the claim cost recovery of the Contractor shall be so limited.”

Add the following to Section 109 of the Standard Specifications.

“109.13 Payment for Contract Delay. Compensation for escalated material costs, escalated labor costs, extended project overhead, and extended traffic control will be allowed when such costs result from a delay meeting the criteria in the following table.

Contract Type	Cause of Delay	Length of Delay
Working Days	Article 108.04(b)(3) or Article 108.04(b)(4)	No working days have been charged for two consecutive weeks.
Completion Date	Article 108.08(b)(1) or Article 108.08(b)(7)	The Contractor has been granted a minimum two week extension of contract time, according to Article 108.08.

Payment for each of the various costs will be according to the following.

- (a) Escalated Material and/or Labor Costs. When the delay causes work, which would have otherwise been completed, to be done after material and/or labor costs have increased, such increases will be paid. Payment for escalated material costs will be limited to the increased costs substantiated by documentation furnished by the Contractor. Payment for escalated labor costs will be limited to those items in Article 109.04(b)(1) and (2), except the 35 percent and 10 percent additives will not be permitted.
- (b) Extended Project Overhead. For the duration of the delay, payment for extended project overhead will be paid as follows.
 - (1) Direct Jobsite and Offsite Overhead. Payment for documented direct jobsite overhead and documented direct offsite overhead, including onsite supervisory and administrative personnel, will be allowed according to the following table.

Original Contract Amount	Supervisory and Administrative Personnel
Up to \$5,000,000	One Project Superintendent
Over \$ 5,000,000 - up to \$25,000,000	One Project Manager, One Project Superintendent or Engineer, and One Clerk
Over \$25,000,000 - up to \$50,000,000	One Project Manager, One Project Superintendent, One Engineer, and

	One Clerk
Over \$50,000,000	One Project Manager, Two Project Superintendents, One Engineer, and One Clerk

(2) Home Office and Unabsorbed Overhead. Payment for home office and unabsorbed overhead will be calculated as 8 percent of the total delay cost.

(c) Extended Traffic Control. Traffic control required for an extended period of time due to the delay will be paid. For working day contracts the payment will be made according to Article 109.04. For completion date contracts, an adjustment will be determined as follows.

Extended Traffic Control occurs between April 1 and November 30:

$$\text{ETCP Adjustment (\$)} = \text{TE} \times (\% / 100 \times \text{CUP} / \text{OCT})$$

Extended Traffic Control occurs between December 1 and March 31:

$$\text{ETCP Adjustment (\$)} = \text{TE} \times 1.5 (\% / 100 \times \text{CUP} / \text{OCT})$$

Where: TE = Duration of approved time extension in calendar days.
 % = Percent maintenance for the traffic control, % (see table below).
 CUP = Contract unit price for the traffic control pay item in place during the delay.
 OCT = Original contract time in calendar days.

Original Contract Amount	Percent Maintenance
Up to \$2,000,000	65%
\$2,000,000 to \$10,000,000	75%
\$10,000,000 to \$20,000,000	85%
Over \$20,000,000	90%

When an ETCP adjustment is paid under this provision, an adjusted unit price as provided for in Article 701.20(a) for increase or decrease in the value of work by more than ten percent will not be paid.

Upon payment for a contract delay under this provision, the Contractor shall assign subrogation rights to the Department for the Department's efforts of recovery from any other party for monies paid by the Department as a result of any claim under this provision. The Contractor shall fully cooperate with the Department in its efforts to recover from another party any money paid to the Contractor for delay damages under this provision."

OWNER COPY

CONTRACT

**JACKSON POND OVERFLOW PROJECT
VILLAGE OF VILLA PARK**

APPENDIX D

IDOT HIGHWAY STANDARDS

OWNER COPY

CONTRACT

ADJUSTMENT ITEMS	EX	PR	ALIGNMENT ITEMS	EX	PR	CONTOUR ITEMS	EX	PR
Structure To Be Adjusted		ADJ	Baseline			Approx. Index Line		
Structure To Be Cleaned		C	Centerline			Approx. Intermediate Line		
Main Structure To Be Filled		FM	Centerline Break Circle	○	○	Index Contour		
Structure To Be Filled		F	Baseline Symbol	⊞	⊞	Intermediate Contour		
Structure To Be Filled Special		FSP	Centerline Symbol	⊞	⊞	DRAINAGE ITEMS		
Structure To Be Removed		R	PI Indicator	△	△	Channel or Stream Line		
Structure To Be Reconstructed		REC	Point Indicator	○	○	Culvert Line		
Structure To Be Reconstructed Special		RSP	Horizontal Curve Data (Half Size)	<p>CURVE P.L. STA=</p> <p>A=</p> <p>D=</p> <p>R=</p> <p>L=</p> <p>E=</p> <p>⊞ R=</p> <p>S.E. RUN=</p> <p>P.C. STA=</p> <p>P.T. STA=</p>	<p>CURVE P.L. STA=</p> <p>A=</p> <p>D=</p> <p>R=</p> <p>L=</p> <p>E=</p> <p>⊞ R=</p> <p>S.E. RUN=</p> <p>P.C. STA=</p> <p>P.T. STA=</p>	Grading & Shaping Ditches		
Frame and Grate To Be Adjusted		A	BOUNDARIES ITEMS			Drainage Boundary Line		
Frame and Lid To Be Adjusted		A	Dashed Property Line	- - - -	- - - -	Paved Ditch		
Domestic Service Box To Be Adjusted		A	Solid Property/Lot Line	_____	_____	Aggregate Ditch		
Valve Vault To Be Adjusted		A	Section/Grant Line	_____	_____	Pipe Underdrain		
Special Adjustment		SP	Quarter Section Line	_____	_____	Storm Sewer		
Item To Be Abandoned		AB	Quarter/Quarter Section Line	_____	_____	Flowline		
Item To Be Moved		M	County/Township Line	_____	_____	Ditch Check		
Item To Be Relocated		REL	State Line	- - - -	- - - -	Headwall		
Pavement Removal and Replacement			Iron Pipe Found	○	○	Inlet		
			Iron Pipe Set	●	●	Manhole		
			Survey Marker	◐	◐	Summit		
			Property Line Symbol	⊞	⊞	Roadway Ditch Flow		
			Same Ownership Symbol (Half Size)	↗	↗	Swale		
			Northwest Quarter Corner (Half Size)	⊞	⊞	Catch Basin		
			Section Corner (Half Size)	⊞	⊞	Culvert End Section		
			Southeast Quarter Corner (Half Size)	⊞	⊞	Water Surface Indicator		
						Riprap		

STANDARD SYMBOLS, ABBREVIATIONS AND PATTERNS
(Sheet 2 of 8)

STANDARD 000001-06

Illinois Department of Transportation

PASSED January 1, 2011

ENGINEER OF POLICY AND PROCEDURES

APPROVED January 1, 2011

ENGINEER OF DESIGN AND ENVIRONMENT

ISSUED 1-1-97

EROSION & SEDIMENT CONTROL ITEMS	EX	PR	NON-HIGHWAY IMPROVEMENT ITEMS	EX	PR	EXISTING LANDSCAPING ITEMS (contd.)	EX	PR
Cleaning & Grading Limits			Noise Attn./Levee			Seeding Class 5		
Dike			Field Line			Seeding Class 7		
Erosion Control Fence			Fence			Seedlings Type 1		
Perimeter Erosion Barrier			Base of Levee			Seedlings Type 2		
Temporary Fence			Mailbox			Sodding		
Ditch Check Temporary			Multiple Mailboxes			Mowstake w/Sign		
Ditch Check Permanent			Pay Telephone			Tree Trunk Protection		
Inlet & Pipe Protection			Advertising Sign			Evergreen Tree		
Sediment Basin						Shade Tree		
Erosion Control Blanket			LANDSCAPING ITEMS	EX	PR			
Fabric Formed Concrete Revetment Mat			Contour Mounding Line			Duct		
Turf Reinforcement Mat			Fence			Conduit		
Mulch Temporary			Fence Post			Electrical Aerial Cable		
Mulch Method 1			Shrubs			Electrical Buried Cable		
Mulch Method 2 Stabilized			Mowline			Controller		
Mulch Method 3 Hydraulic			Perennial Plants			Underpass Luminaire		
			Seeding Class 2			Power Pole		
			Seeding Class 2A					
			Seeding Class 4					
			Seeding Class 4 & 5 Combined					

STANDARD SYMBOLS, ABBREVIATIONS AND PATTERNS
(Sheet 3 of 8)

STANDARD 000001-06

Illinois Department of Transportation

PASSED January 1, 2011
Michael Beard
 ENGINEER OF POLICY AND PROCEDURES

APPROVED January 1, 2011
Seamus
 ENGINEER OF DESIGN AND ENVIRONMENT

ISSUED 1-1-97

LIGHTING
(cont'd.)

Pull Point
Handhole
Heavy Duty Handhole
Junction Box
Light Unit Comb.
Electrical Ground
Traffic Flow Arrow
High Mast Pole
(trifit Size)
Light Unit-1

EX



PR



PAVEMENT (MISC.)

Keyed Long. Joint
Keyed Long. Joint w/Tie Bars
Sawed Long. Joint w/Tie Bars
Bituminous Shoulder
Bituminous Taper
Stabilized Driveway
Widening

EX



PR

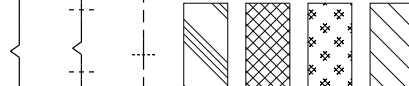

PAVEMENT MARKINGS

Bike Lane Symbol
Bike Lane Text
Handicap Symbol
RR Crossing
Raised Marker Amber 1 Way
Raised Marker Amber 2 Way
Raised Marker Crystal 1 Way

EX



PR



Two Way Turn Left
Shoulder Diag. Pattern
Skip-Dash White
Skip-Dash Yellow
Stop Line
Solid Line
Double Centerline
Dotted Lines
CL 2Ln 2Way
RRPM 12.2 m (40') o.c.
CL 2Ln 2Way
RRPM 80' (24.4 m) o.c.
CL Multilane Div.
RRPM 40' (12.2 m) o.c.
CL Multilane Div.
RRPM 80' (24.4 m) o.c.
CL Multilane Div. Dbl.
RRPM 80' (24.4 m) o.c.
CL Multilane Undiv.
Two Way Turn Left Line



**STANDARD SYMBOLS,
ABBREVIATIONS
AND PATTERNS**
(Sheet 4 of 8)

STANDARD 000001-06

Illinois Department of Transportation
PASSED January 1, 2011
Michael Board
ENGINEER OF POLICY AND PROCEDURES
APPROVED January 1, 2011
S. J. [Signature]
ENGINEER OF DESIGN AND ENVIRONMENT

ISSUED 1-1-97

PAVEMENT MARKINGS
(contd.)

- Urban Combination Left
- Urban Combination Right
- Urban Left Turn Arrow
- Urban Right Turn Arrow
- Urban Left Turn Only
- Urban Right Turn Only
- Urban Thru Only
- Urban U-Turn
- Urban Combined U-Turn
- Rural Combination Left
- Rural Combination Right
- Rural Left Turn Arrow
- Rural Right Turn Arrow
- Rural Left Turn Only
- Rural Right Turn Only
- Rural Thru Only

EX

PR



RAILROAD ITEMS

- Abandoned Railroad
- Railroad
- Railroad Point
- Control Box
- Crossing Gate
- Flashing Signal
- Railroad Cant., Mast Arm
- Crossbuck

PR

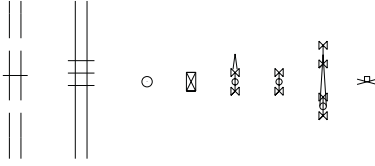

EX

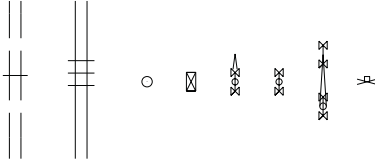

REMOVAL ITEMS

- Removal Tic
- Bituminous Removal
- Hatch Pattern
- Tree Removal Single

EX

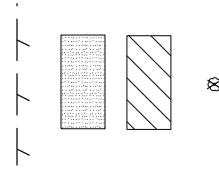

PR

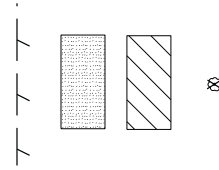

RIGHT OF WAY ITEMS

- Future ROW Corner Monument
- ROW Marker
- ROW Line
- Easement
- Temporary Easement

EX

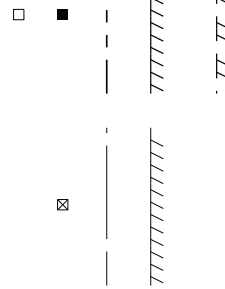

PR

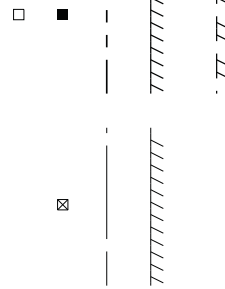

**STANDARD SYMBOLS,
ABBREVIATIONS
AND PATTERNS**
(Sheet 5 of 8)

STANDARD 000001-06

Illinois Department of Transportation PASSED January 1, 2011 ENGINEER OF POLICY AND PROCEDURES APPROVED January 1, 2011 ENGINEER OF DESIGN AND ENVIRONMENT	ISSUED 1-1-97
	Michael Beard Jennifer A. Smith

RIGHT OF WAY ITEMS (contd.)	EX	PR	ROADWAY PROFILES	EX	PR	SIGNING ITEMS (contd.)	EX	PR
Access Control Line	— AC —	— AC —	P.I. Indicator	△	△	Reverse Left W1-4L (Half Size)		
Access Control Line & ROW	— AC — — AC —	— AC —	Point Indicator	○	○	Reverse Right W1-4R (Half Size)		
Access Control Line & ROW with Fence	— AR — — AC —	— AC —	Earthworks Balance Point			Two Way Traffic Sign W6-3 (Half Size)		
Excess ROW Line	— XS —	— XS —	Begin Point			Detour Ahead W20-2(O) (Half Size)		
ROADWAY PLAN ITEMS			Vert. Curve Data	VPI = ELEV = L = E =	VPI = ELEV = L = E =	Left Lane Closed Ahead W20-5(L)(O) (Half Size)		
Cable Barrier			Ditch Profile Left Side	-----	-----	Right Lane Closed Ahead W20-5(R)(O) (Half Size)		
Concrete Barrier			Ditch Profile Right Side	-----	-----	Road Closed Ahead W20-3(O) (Half Size)		
Edge of Pavement	-----	-----	Roadway Profile Line	-----	-----	Road Construction Ahead W20-1(O) (Half Size)		
Bit Shoulders, Medians and C&G Line	-----	-----	Storm Sewer Profile Left Side	-----	-----	Single Lane Ahead (Half Size)		
Aggregate Shoulder	-----	-----	Storm Sewer Profile Right Side	-----	-----	Transition Left W4-2L (Half Size)		
Sidewalks, Driveways	-----	-----	SIGNING ITEMS			Transition Right W4-2R (Half Size)		
Guardrail			Cone, Drum or Barricade	○	○			
Guardrail Post	○	○	Barricade Type II					
Traffic Sign			Barricade Type III					
Corrugated Median			Barricade With Edge Line					
Impact Attenuator			Flashing Light Sign	○	○			
North Arrow with District Office (Half Size)			Panels I					
Match Line	-----	-----	Panels II					
Slope Limit Line	-----	-----	Direction of Traffic					
Typical Cross-Section Line	-----	-----	Sign Flag (Half Size)					

STANDARD SYMBOLS, ABBREVIATIONS AND PATTERNS
(Sheet 6 of 8)

STANDARD 000001-06

Illinois Department of Transportation

PASSED January 1, 2011
Michael Beard
 ENGINEER OF POLICY AND PROCEDURES

APPROVED January 1, 2011
Jeffrey A. ...
 ENGINEER OF DESIGN AND ENVIRONMENT

ISSUED 1-1-97

SIGNING ITEMS (cont'd.)	EX	PR	STRUCTURES ITEMS	EX	PR	TRAFFIC SHEET ITEMS	EX	PR
One Way Arrow Lrg. W1-6-(0) (Half Size)			Box Culvert Barrel	-----	-----	Cable Number		
Two Way Arrow Large W1-7-(0) (Half Size)			Box Culvert Headwall	-----	-----	Left Turn Green		
Detour M4-10L-(0) (Half Size)			Bridge Pier	-----	-----	Left Turn Yellow		
Detour M4-10R-(0) (Half Size)			Bridge	-----	-----	Signal Backplate		
One Way Left R6-1L (Half Size)			Retaining Wall	-----	-----	Signal Section 8' (200 mm)		
One Way Right R6-1R (Half Size)			Temporary Sheet Piling	-----	-----	Signal Section 12" (300 mm)		
Left Turn Lane R3-1100L (Half Size)						Walk/Don't Walk Letters		
Keep Left R4-TAL (Half Size)						Walk/Don't Walk Symbols		
Keep Left R4-TBL (Half Size)								
Keep Right R4-TAR (Half Size)								
Keep Right R4-TBR (Half Size)								
Stop Here On Red R10-6-AL (Half Size)								
Stop Here On Red R10-6-AR (Half Size)								
No Left Turn R3-2 (Half Size)								
No Right Turn R3-1 (Half Size)								
Road Closed R11-2 (Half Size)								
Road Closed Thru Traffic R11-2 (Half Size)								

**STANDARD SYMBOLS,
ABBREVIATIONS
AND PATTERNS**
(Sheet 7 of 8)

STANDARD 000001-06

Illinois Department of Transportation

PASSED January 1, 2011
Michael Beard
 ENGINEER OF POLICY AND PROCEDURES

APPROVED January 1, 2011
Jeffrey S. ...
 ENGINEER OF DESIGN AND ENVIRONMENT

ISSUED 1-1-97

TRAFFIC SIGNAL ITEMS (contd.)

Detector Raceway		
Aluminum Mast Arm		
Steel Mast Arm		
Veh. Detector Magnetic		
Conduit Splice		
Controller		
Gifbox Junction		
Wood Pole		
Temp. Signal Head		
Handhole		
Double Handhole		
Heavy Duty Handhole		
Junction Box		
Ped. Pushbutton Detector		
Ped. Signal Head		
Power Pole Service		
Priority Veh. Detector		
Signal Head		
Signal Head w/Backplate		
Signal Post		
Closed Circuit TV		
Video Detector System		

UNDERGROUND UTILITY ITEMS

Cable TV			
Electric Cable			
Fiber Optic			
Gas Pipe			
Oil Pipe			
Sanitary Sewer			
Telephone Cable			
Water Pipe			

UTILITIES ITEMS

Controller			
Double Handhole			
Fire Hydrant			
GuyWire or Deadman Anchor			
Handhole			
Heavy Duty Handhole			
Junction Box			
Light Pole			
Manhole			
Pipeline Warning Sign			
Power Pole			
Power Pole with Light			
Sanitary Sewer Cleanout			
Splice Box Above Ground			
Telephone Splice Box Above Ground			
Telephone Pole			

UTILITY ITEMS (contd.)

Traffic Signal		
Traffic Signal Control Box		
Water Meter		
Water Meter Valve Box		
Profile Line		
Aerial Power Line		

VEGETATION ITEMS

Deciduous Tree		
Bush or Shrub		
Evergreen Tree		
Stump		
Orchard/Nursery Line		
Vegetation Line		
Woods & Bush Line		

WATER FEATURE ITEMS

Stream or Drainage Ditch		
Waters Edge		
Water Surface Indicator		
Water Point		
Disappearing Ditch		
Marsh		
Marsh/Swamp Boundary		

STANDARD SYMBOLS, ABBREVIATIONS AND PATTERNS
(Sheet 8 of 8)

STANDARD 000001-06

Illinois Department of Transportation PASSED January 1, 2011 ENGINEER OF POLICY AND PROCEDURES APPROVED January 1, 2011 ENGINEER OF DESIGN AND ENVIRONMENT	ISSUED 1-1-97
	Michael Beard January 1, 2011
	[Signature] January 1, 2011
	[Signature] January 1, 2011

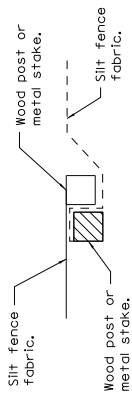

Place end-post (stake) of first slit fence adjacent to end-post (stake) of second slit fence with fabric positioned as shown.

STEP 1



Rotate posts (stakes) together 180° clockwise and drive both posts (stakes) 18 (450) into ground.

STEP 2

ATTACHING TWO SLIT FILTER FENCES
(Not applicable for J-hooks)

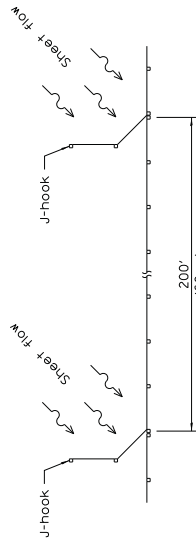

SILT FILTER J-HOOK PLACEMENT

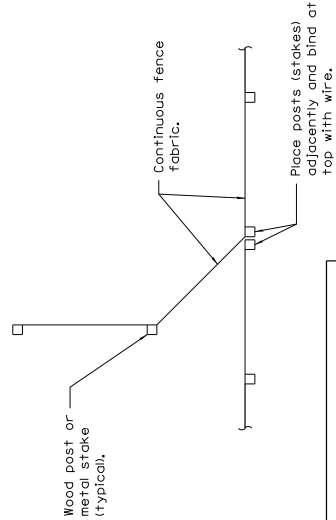

Illinois Department of Transportation	ISSUED	1-1-97
PASSED	JANUARY 1, 2013	
Michael Bond	ENGINEER OF POLICY AND PROCEDURES	
APPROVED	JANUARY 1, 2013	
ENGINEER OF DESIGN AND ENVIRONMENT		

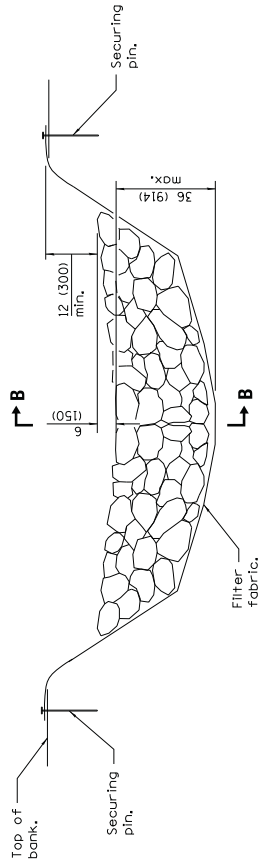

ELEVATION

• When the ditch check is within the clear zone and the road is open to traffic, the traffic approach slope of the aggregate shall be 1:4 (V:H).

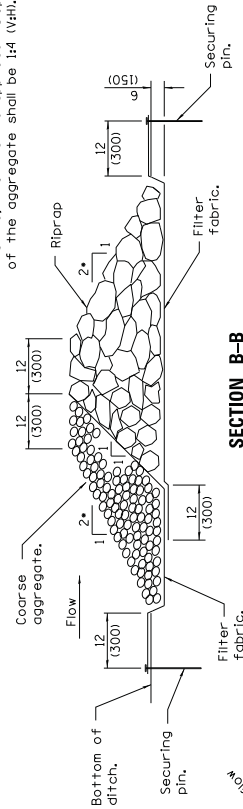

SECTION B-B

AGGREGATE DITCH CHECK

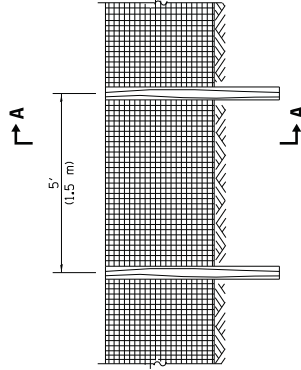

ELEVATION

SILT FILTER FENCE AS A PERIMETER EROSION BARRIER

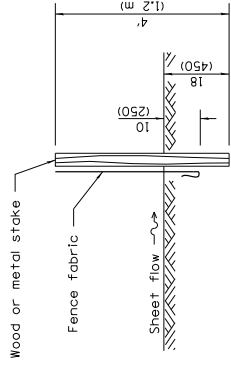

SLICE METHOD

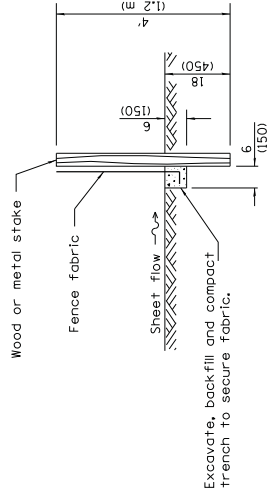

TRENCH METHOD

SECTION A-A

GENERAL NOTES

The installation details and dimensions shown for perimeter erosion barriers shall also apply for inlet and pipe protection.

All dimensions are in inches (millimeters) unless otherwise shown.

DATE	REVISIONS
1-1-13	Corrected notation for flowline (E) on SEDIMENT BASIN ELEVATION.
1-1-12	Omitted hay/straw perimeter barrier. Added SLICE METHOD to SECTION A-A.

TEMPORARY EROSION CONTROL SYSTEMS
(Sheet 1 of 1)

STANDARD 280001-07

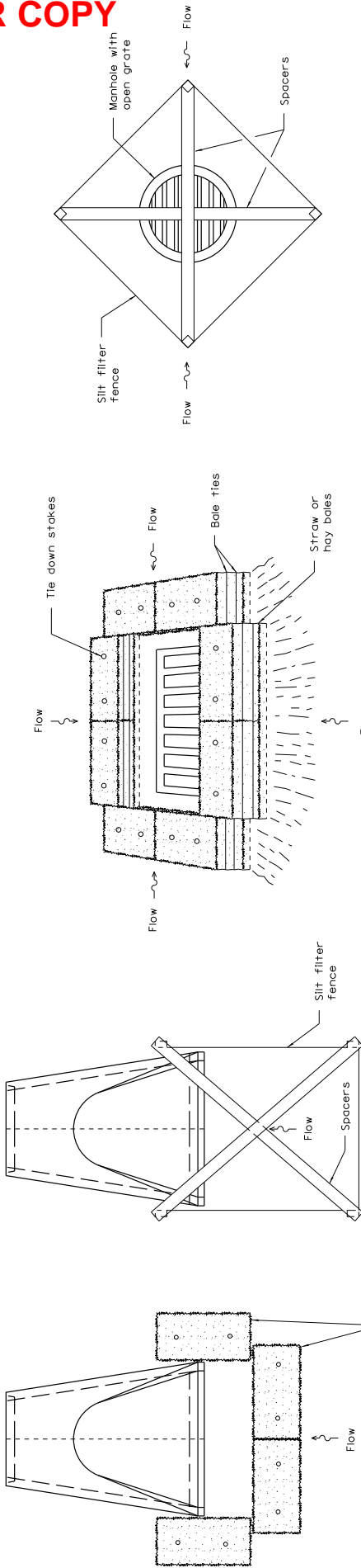

INLET AND PIPE PROTECTION

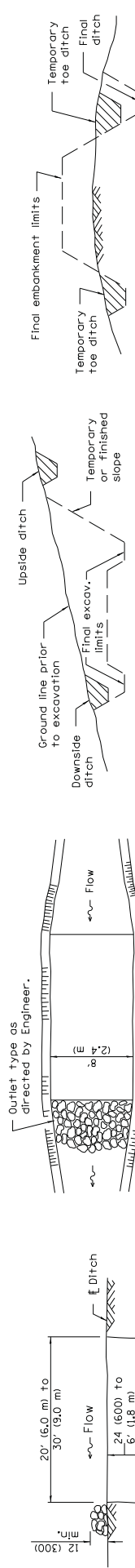

ELEVATION

The long dimension should be parallel with the direction of the flow. Accumulated silt shall be removed anytime the basins become 75% filled.

PLAN

SEDIMENT BASIN

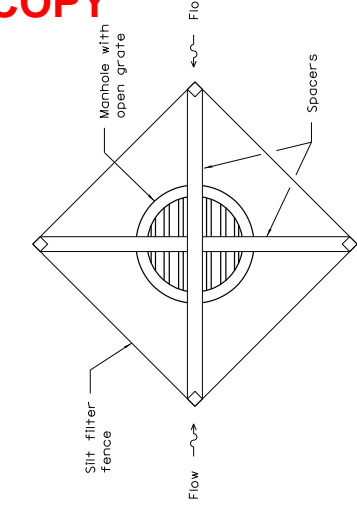

TYPICAL FILL CROSS-SECTION

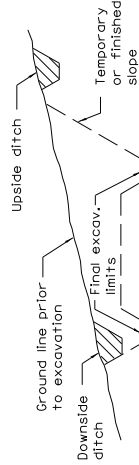

TYPICAL CUT CROSS-SECTION

TEMPORARY DITCHES FOR CUT & FILL SECTIONS

TEMPORARY EROSION CONTROL SYSTEMS
 (Sheet 2 of 2)
STANDARD 280001-07

Illinois Department of Transportation
 PASSED JANUARY 1, 2013
 ENGINEER OF POLICY AND PROCEDURES
 APPROVED JANUARY 1, 2013
 ENGINEER OF DESIGN AND ENVIRONMENT

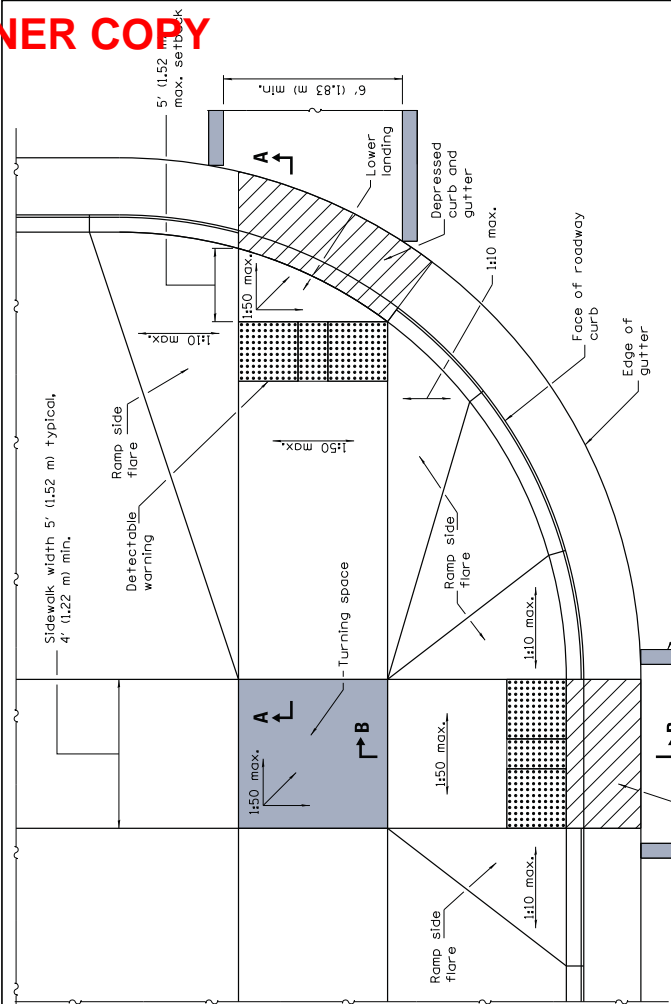

RAMPS IN LANSCAPED AREA
SETBACK ≤ 5'

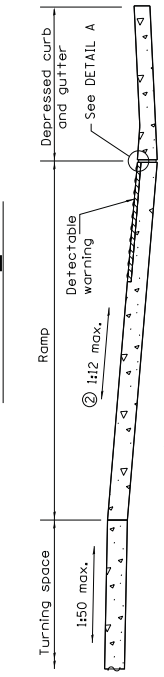

SECTION A-A

② The running slope of the curb ramp shall not require the ramp length to exceed 15' (4.5 m).

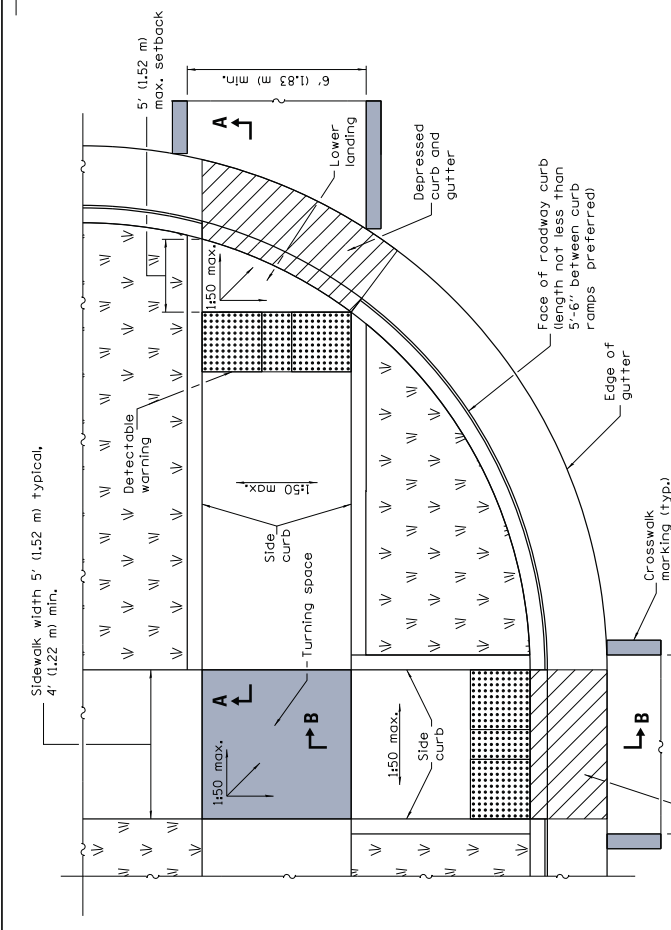

RAMPS IN PAVED AREA
SETBACK ≤ 5'

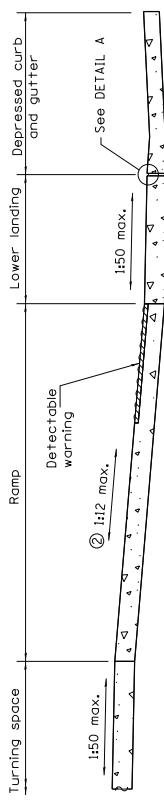

SECTION B-B

② The running slope of the curb ramp shall not require the ramp length to exceed 15' (4.5 m).

Flush with top of roadway curb and top of sidewalk



SIDE CURB DETAIL

See Sheet 2 for GENERAL NOTES.

DATE	REVISIONS
1-1-17	Added 2' dimension to det. warnings for setbacks greater than 5'.
1-1-15	① not appl. to int. sidewalks. Rev. gen. notes, Ch'd Upper landing to Turning space.

PERPENDICULAR CURB RAMPS FOR SIDEWALKS

(Sheet 1 of 2)
STANDARD 424001-09

Illinois Department of Transportation PASSED JANUARY 1, 2017 Michael Board ENGINEER OF POLICY AND PROCEDURES APPROVED JANUARY 1, 2017 Matthew R. Board ENGINEER OF DESIGN AND ENVIRONMENT	ISSUED 1-1-97
---	---------------

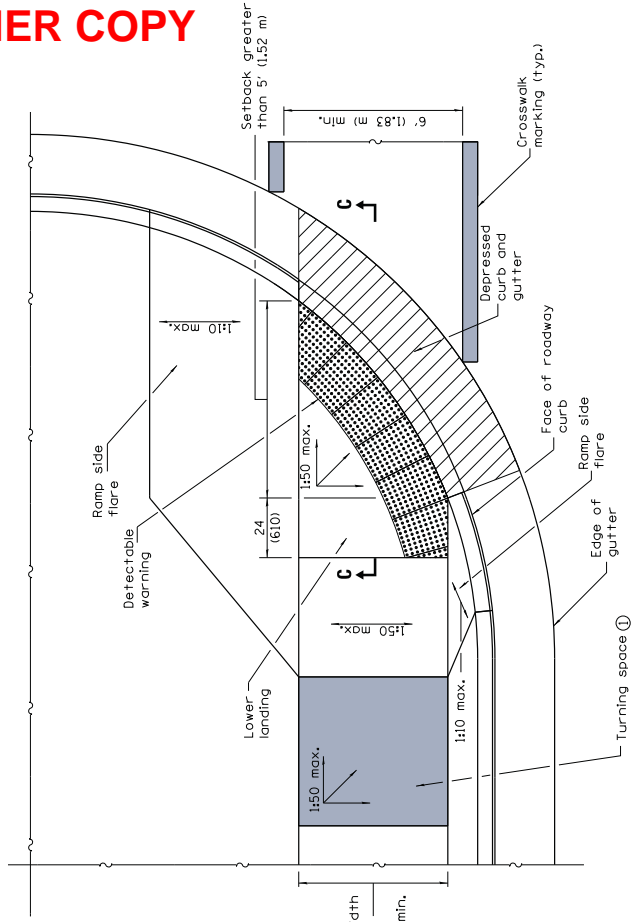

RAMP IN LANDSCAPED AREA

SETBACK > 5'

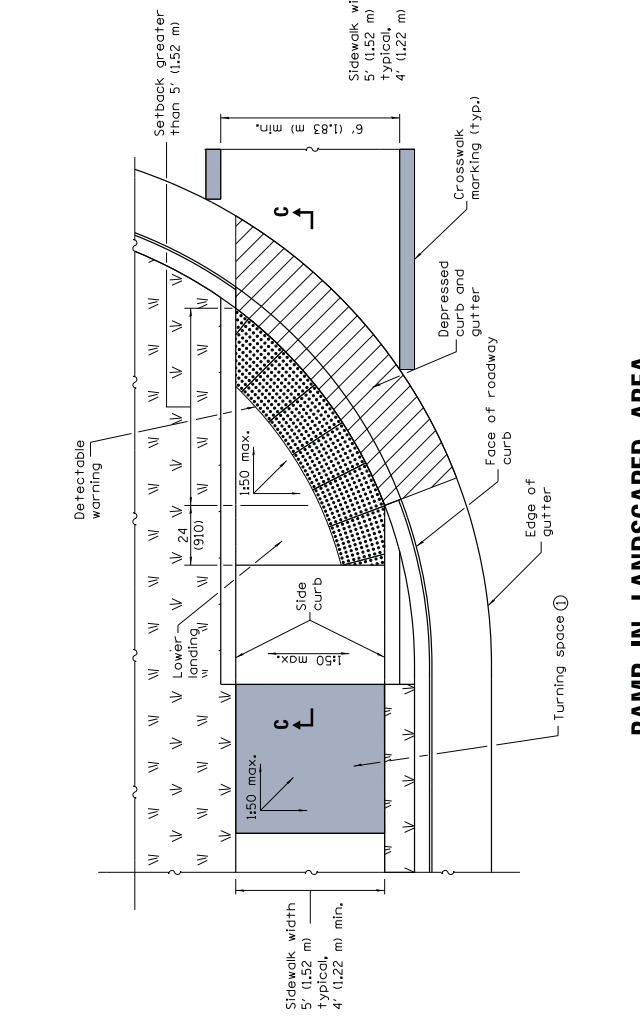

RAMP IN PAVED AREA

SETBACK > 5'

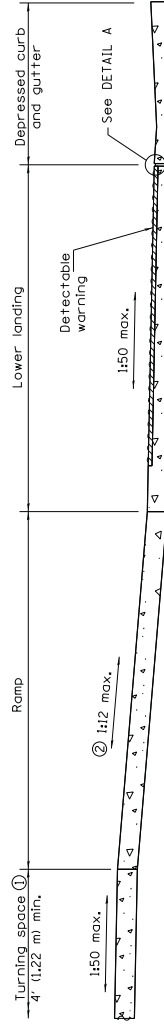

SECTION C-C

- ① Turning space not required for ramp slopes flatter than 1:20.
- ② The running slope of the curb ramp shall not require the ramp length to exceed 15' (4.5 m).

GENERAL NOTES

All slope ratios are expressed as units of vertical displacement to units of horizontal displacement (V:H).

Where the turning space is constrained on a side opposite a ramp, the minimum length of the turning space in the direction of the ramp-run shall be 5' (1.52 m).

Where 1:50 maximum slope is shown, 1:64 is preferred.

See Standard 606001 for details of depressed curb adjacent to curb ramp.

All dimensions are in inches (millimeters) unless otherwise shown.

PERPENDICULAR CURB RAMPS FOR SIDEWALKS

(Sheet 2 of 2)

STANDARD 424001-09

Illinois Department of Transportation

PASSED JANUARY 1, 2017
 Michael Board
 ENGINEER OF POLICY AND PROCEDURES
 APPROVED JANUARY 1, 2017
 Steven R. [Signature]
 ENGINEER OF DESIGN AND ENVIRONMENT

ISSUED 1-1-97

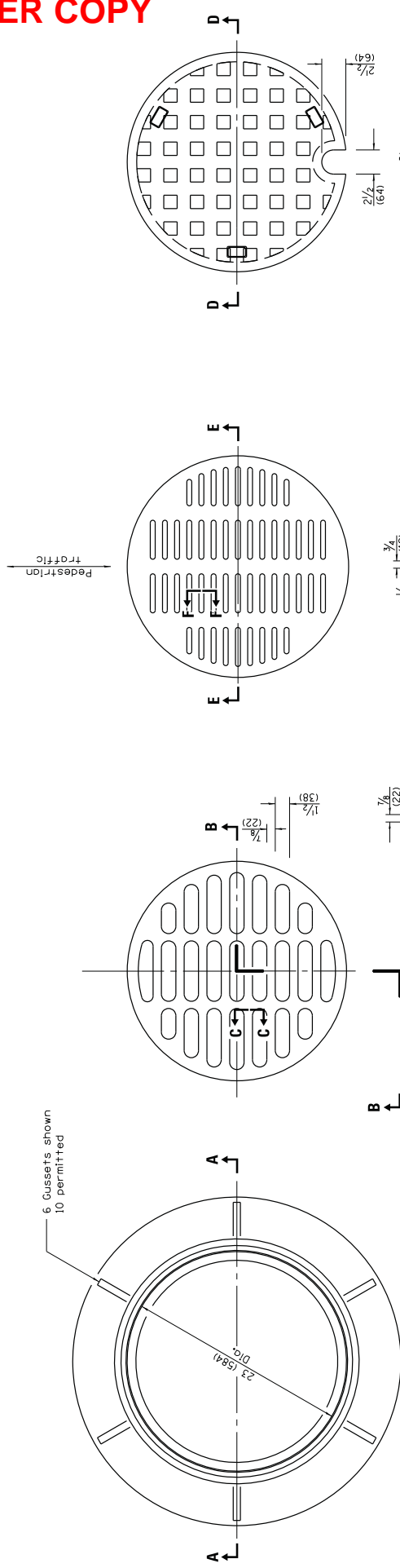

6 Gussets shown
10 permitted

CAST FRAME

SECTION C-C

SECTION F-F

SECTION D-D

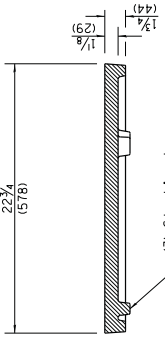

(3) Stacking lugs
at 120° (optional)

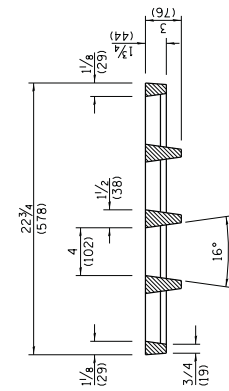

SECTION E-E

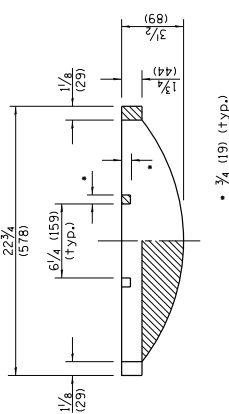

SECTION B-B

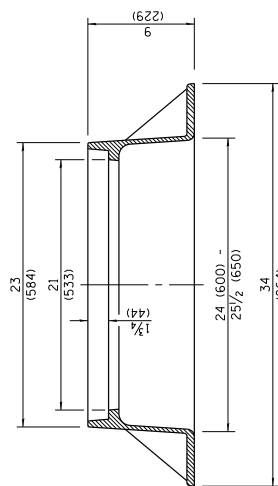

SECTION A-A

Gray Iron

CAST CLOSED LID

Gray Iron Lid

**ADA COMPLIANT
CAST OPEN LID**

CAST OPEN LID

All dimensions are in inches (millimeters) unless otherwise shown.

DATE	REVISIONS
1-1-15	Revised dimensioning of frame. Added ADA compliant open lid.
1-1-09	Switched units to English (metric).

**FRAME AND LIDS
TYPE 1**

STANDARD 604001-04

Illinois Department of Transportation
 PASSED JANUARY 1, 2015
 ENGINEER OF POLICY AND PROCEDURES
 APPROVED JANUARY 1, 2015
 ENGINEER OF DESIGN AND ENVIRONMENT

ISSUED 1-1-97

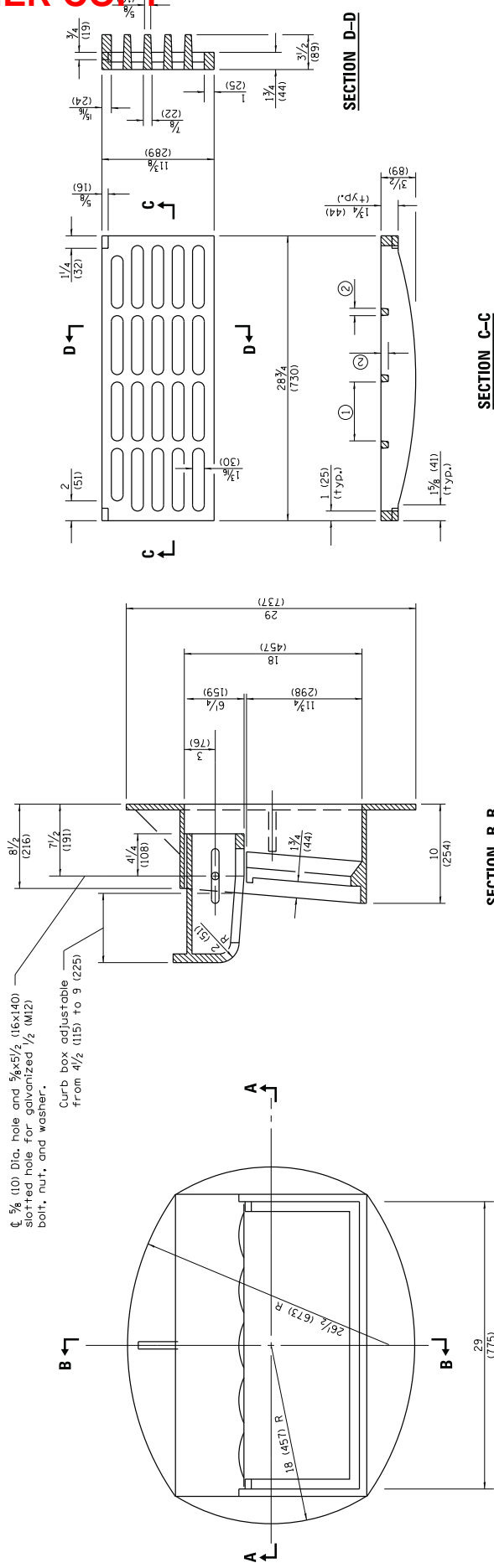

1/8" (10) Dia. hole and 5/8x5/2 (16x140) slotted hole for galvanized 1/2 (M12) bolt, nut, and washer.
 Curb box adjustable from 4 1/2 (115) to 9 (225)

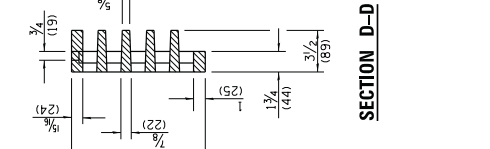
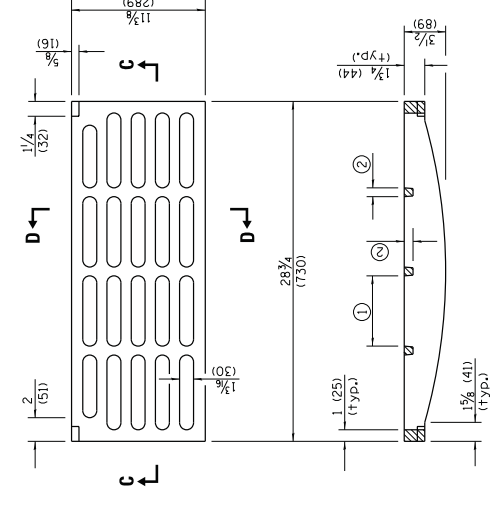
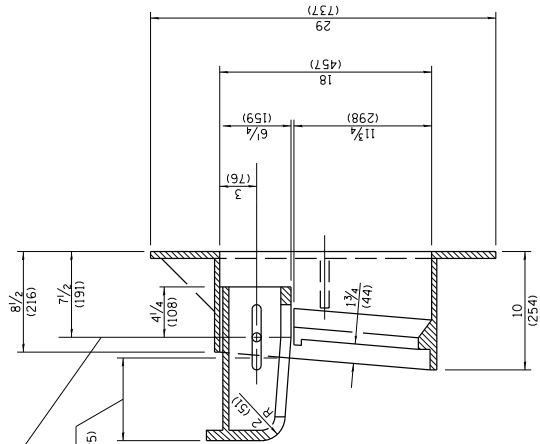

SECTION C-C
 ① = 6/4 (159) max. (typ.)
 ② = 3/4 (19) min. (typ.)

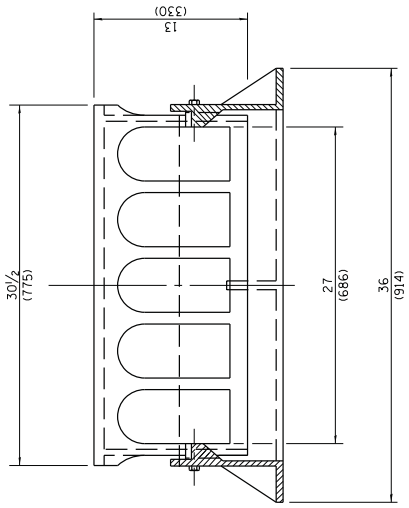
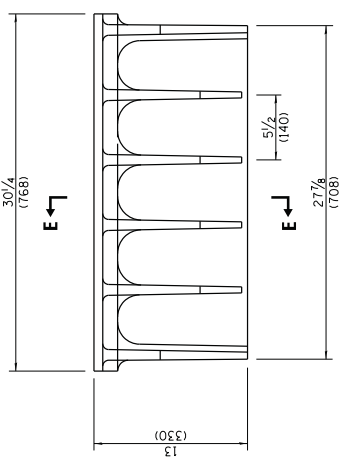

SECTION E-E

ALTERNATE CURB BOX

All dimensions are in inches (millimeters) unless otherwise shown.

REVISIONS	
DATE	Revised dimensions of frame and alternate curb box.
1-1-15	
DATE	Switched units to English metric.
4-1-09	

FRAME AND GRATE TYPE 11

STANDARD 604051-04

Illinois Department of Transportation
 PASSED JANUARY 1, 2015
 ENGINEER OF POLICY AND PROCEDURES
 APPROVED JANUARY 1, 2015
 ENGINEER OF DESIGN AND ENVIRONMENT

ISSUED 1-1-97

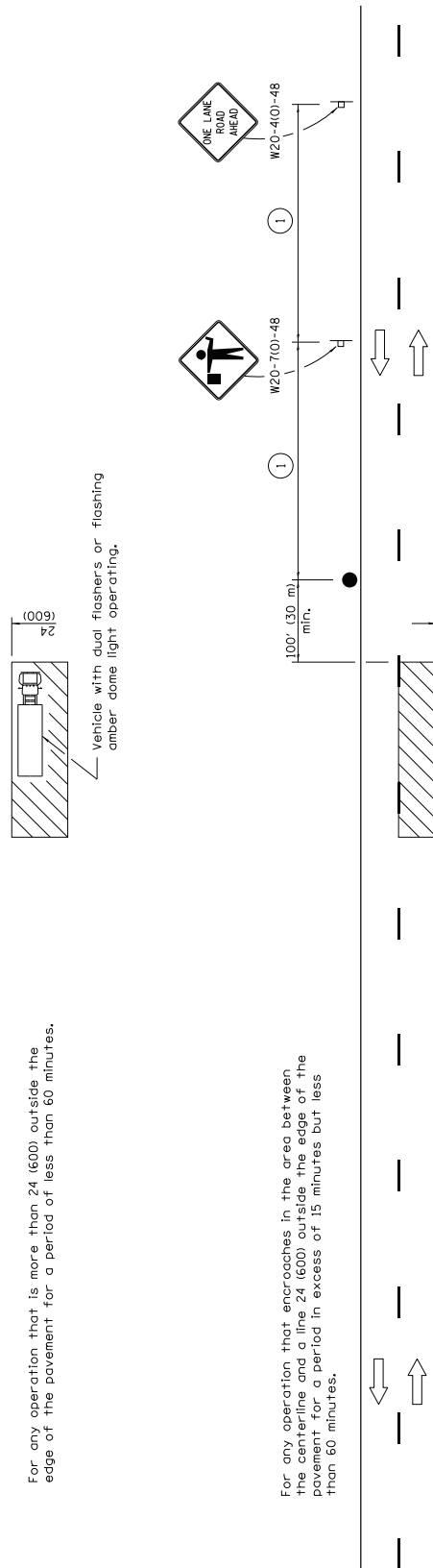
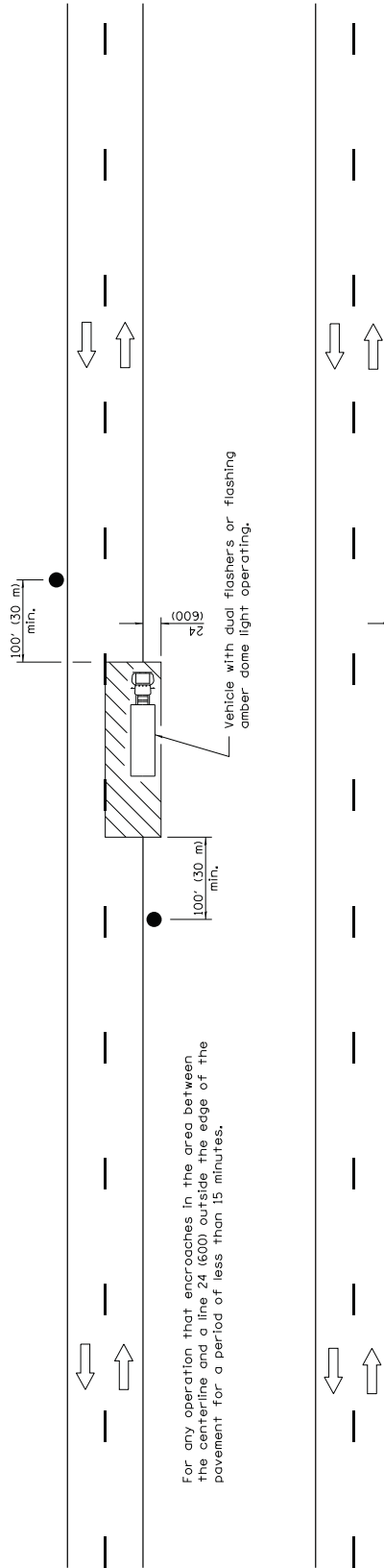

Posted Speed	Sign Spacing
55	500' (150 m)
50-45	350' (100 m)
<45	200' (60 m)

① = Refer to SIGN SPACING table for distances.

All dimensions are in inches (millimeters) unless otherwise shown.

DATE	REVISIONS
1-1-11	Revised flagger sign.
1-1-09	Switched units to English metric.

- TYPICAL APPLICATIONS**
- Marking patches
 - Field survey
 - String line
 - Utility operations
 - Cleaning up debris on pavement
- SYMBOLS**
- Work area
 - Sign on portable or permanent support
 - Flagger with traffic control sign

LANE CLOSURE, 2L, 2W, SHORT TIME OPERATIONS

STANDARD 701301-04

Illinois Department of Transportation

APPROVED *[Signature]* JANUARY 2011
 ENGINEER OF SAFETY ENGINEERING

APPROVED *[Signature]* JANUARY 2011
 ENGINEER OF DESIGN AND ENVIRONMENT

ISSUED 1-1-97

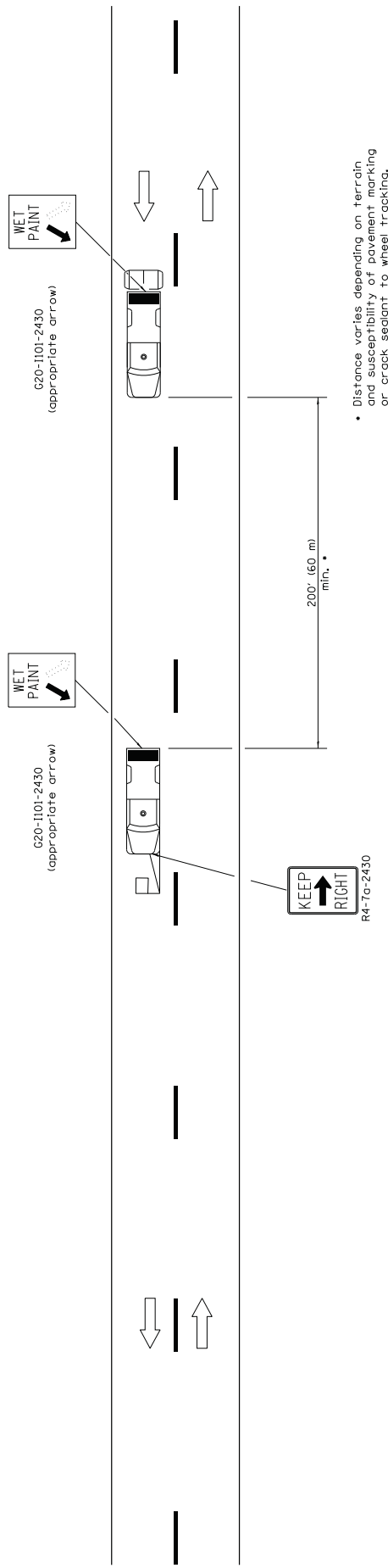

• Distance varies depending on terrain and susceptibility of pavement marking or crack sealant to wheel tracking.

TYPICAL APPLICATIONS

- Landsliding work
- Utility work
- Pavement marking
- Seed spraying
- Radonimeter measurements
- Debris cleanup
- Crack pouring

SYMBOLS

- Arrow board (Hazard Mode only)
- Truck with headlights, emergency flashers, and flashing amber light. (Visible from all directions)
- 18x18 (450x450) min. orange flag (use when guide wheel is used)
- Truck mounted attenuator

GENERAL NOTES

This Standard is used where any vehicle, equipment, workers or their activities will require a continuous moving operation where the average speed is greater than 3 mph (5 km/h).

For shoulder operations not encroaching on the pavement, use DETAIL A, Standard 701426. All dimensions are in inches (millimeters) unless otherwise shown.

DATE	REVISIONS
1-1-09	Switched units to English (metric). Omitted Pass With Care sign.
1-1-00	Elim. speed restrictions in Standard title.

LANE CLOSURE 2L, 2W MOVING OPERATIONS— DAY ONLY

STANDARD 701311-03

Illinois Department of Transportation

ISSUED 1-1-97

APPROVED JANUARY 1, 2009

ENGINEER OF OPERATIONS *[Signature]*

APPROVED JANUARY 1, 2009

ENGINEER OF DESIGN AND ENVIRONMENT *[Signature]*

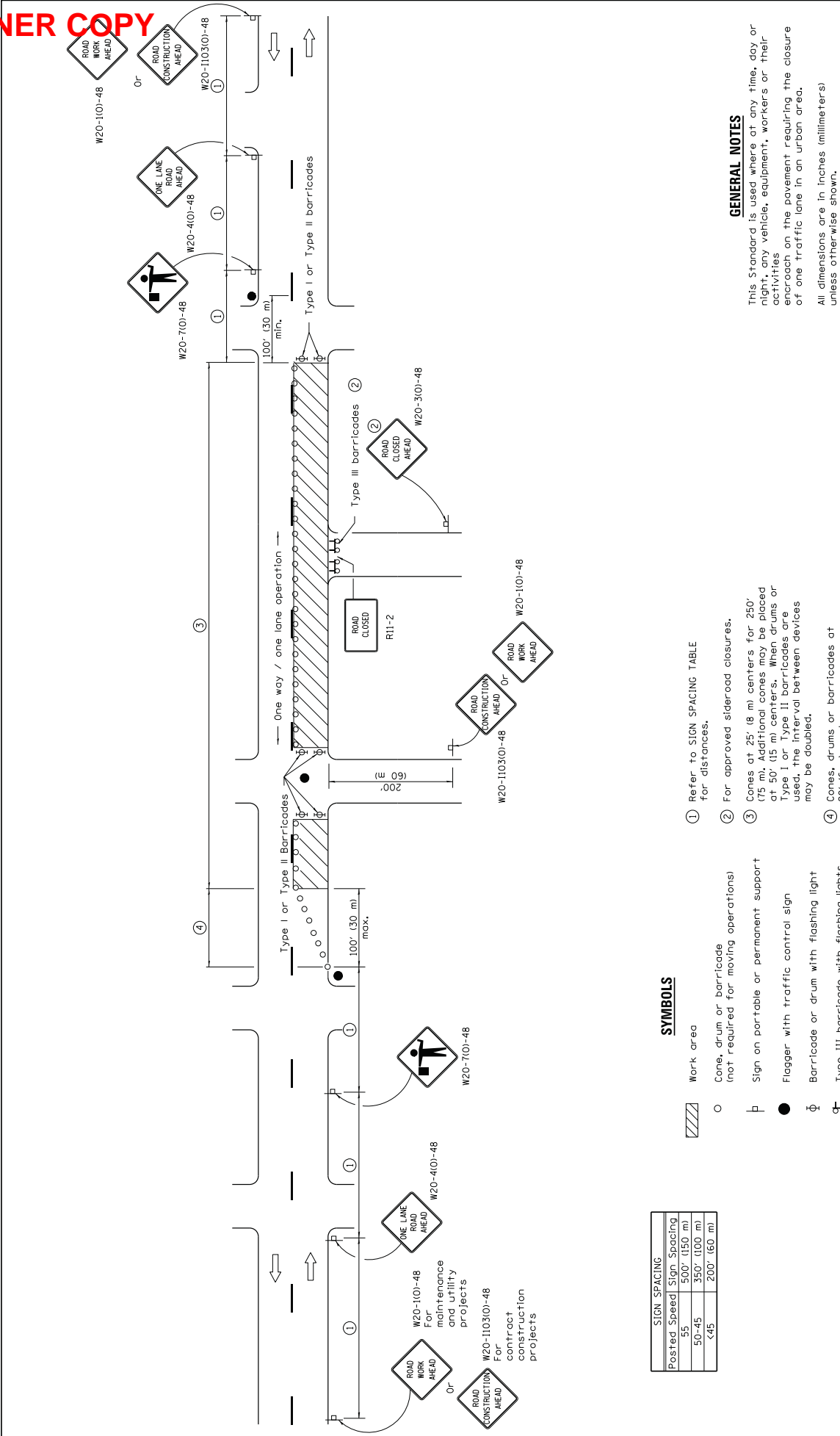

Posted Speed	Sign Spacing
55	500' (150 m)
50-45	350' (100 m)
<45	200' (60 m)

SYMBOLS

- Work area
- Cone, drum or barricade (not required for moving operations)
- Sign on portable or permanent support
- Flagger with traffic control sign
- Barricade or drum with flashing light
- Type III barricade with flashing lights

- ① Refer to SIGN SPACING TABLE for distances.
- ② For approved sideroad closures.
- ③ Cones at 25' (8 m) centers for 250' (75 m). Additional cones may be placed at 50' (15 m) centers. When drums or Type I or Type II barricades are used, the interval between devices may be doubled.
- ④ Cones, drums or barricades at 20' (6 m) centers.

GENERAL NOTES

This Standard is used where at any time, day or night, any vehicle, equipment, workers or their activities encroach on the pavement requiring the closure of one traffic lane in an urban area.

All dimensions are in inches (millimeters) unless otherwise shown.

DATE	REVISIONS
1-1-11	Revised flagger sign.
1-1-09	Switched units to English (metric).
	Corrected sign No.'s.

**URBAN LANE CLOSURE,
2L, 2W, UNDIVIDED**

STANDARD 701501-06

Illinois Department of Transportation

APPROVED *[Signature]* JANUARY 1, 2011
ENGINEER OF SAFETY ENGINEERING

APPROVED *[Signature]* JANUARY 1, 2011
ENGINEER OF DESIGN AND ENVIRONMENT

ISSUED 1-1-97

① Omit whenever duplicated by road work traffic control.

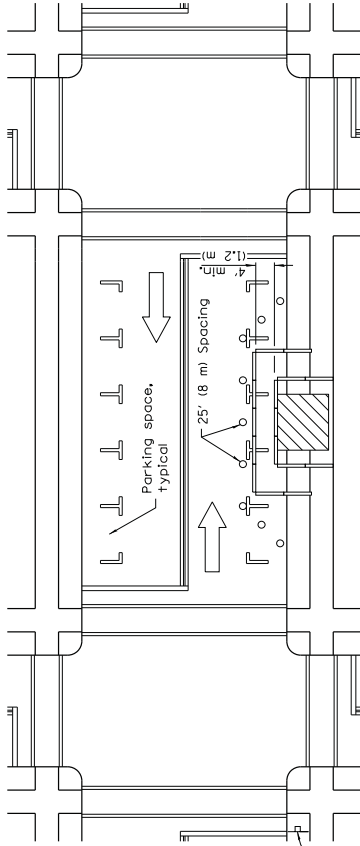

W20-1103101-48 for contract construction projects

or

W20-1101-48 for maintenance and utility projects

SIDEWALK DIVERSION

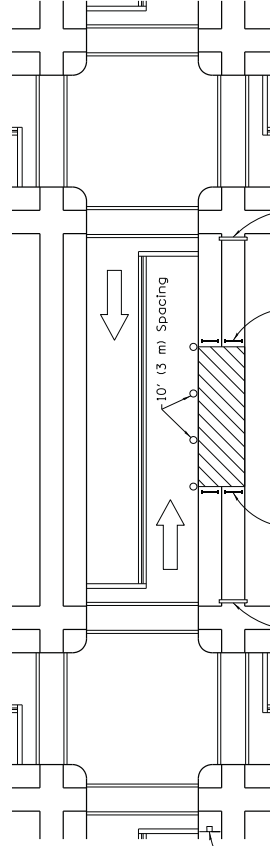

W20-1103101-48 for contract construction projects

or

W20-1101-48 for maintenance and utility projects

SIDEWALK CLOSURE

SYMBOLS

- Work area
- Sign on portable or permanent support
- Barricade or drum
- Cone, drum or barricade
- Type III barricade
- Detectable pedestrian channelizing barricade

GENERAL NOTES

This Standard is used where, at any time, pedestrian traffic must be rerouted due to work being performed.

This Standard must be used in conjunction with other Traffic Control & Protection Standards when roadway traffic is affected.

Temporary facilities shall be detectable and accessible.

The temporary pedestrian facilities shall be provided on the same side of the closed facilities whenever possible.

The SIDEWALK CLOSED / USE OTHER SIDE sign shall be placed at the nearest crosswalk or intersection to each end of the closure. Where the closure occurs at a corner, the signs shall be erected on the corner that closes the street from the closure. The SIDEWALK CLOSED signs shall be used at the ends of the actual closures.

Type III barricades and R11-2-4830 signs shall be positioned as shown in "ROAD CLOSED TO ALL TRAFFIC" detail on Standard 701901.

All dimensions are in inches (millimeters) unless otherwise shown.

DATE	REVISIONS
4-1-16	Omitted orange safety fence from standard as this is covered in the std. spec.
1-1-12	Added SIDEWALK DIVERSION. Modified appearance of plan views. Renamed Std.

SIDEWALK, CORNER OR CROSSWALK CLOSURE

(Sheet 1 of 2)

STANDARD 701801-06

Illinois Department of Transportation
 APPROVED: *[Signature]* APRIL 1, 2016
 ENGINEER OF SAFETY ENGINEERING
 APPROVED: *[Signature]* APRIL 1, 2016
 ENGINEER OF DESIGN AND ENVIRONMENT

ISSUED 1-1-97

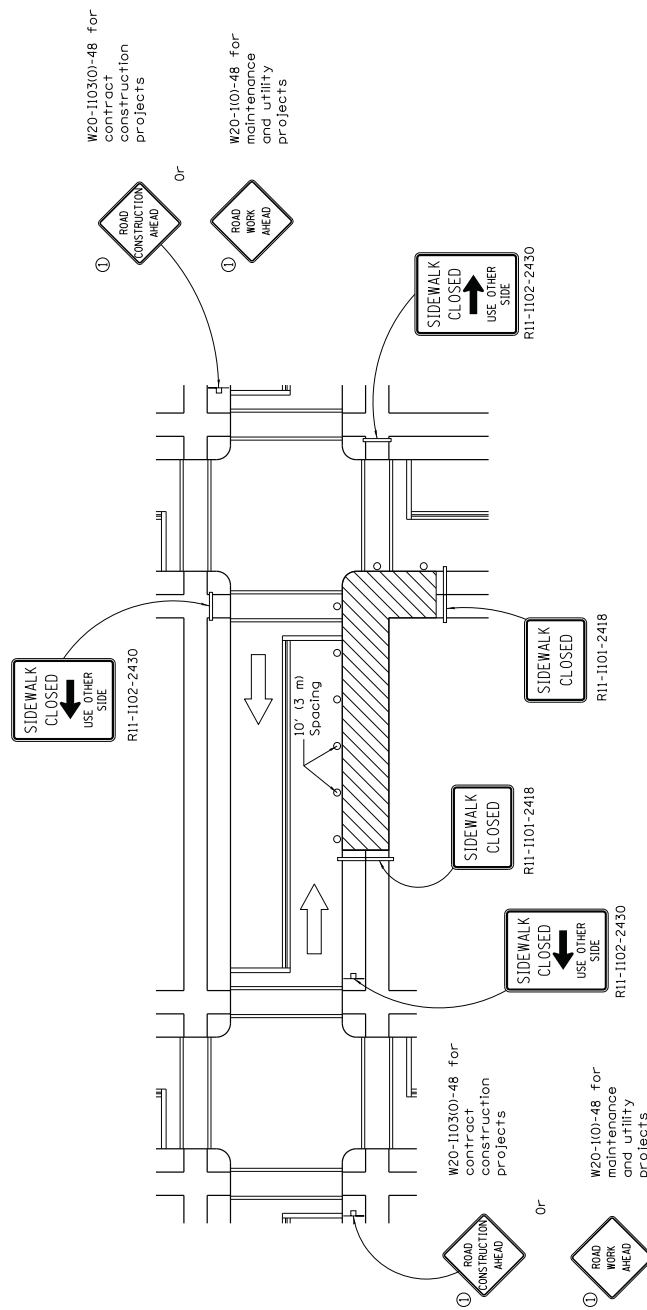

CORNER CLOSURE

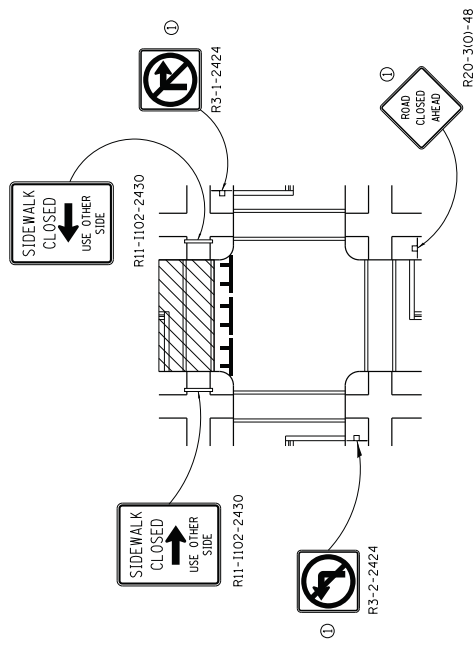

CROSSWALK CLOSURE

SIDEWALK, CORNER OR CROSSWALK CLOSURE
 (Sheet 2 of 2)
STANDARD 701801-06

Illinois Department of Transportation
 APPROVED April 11, 2016
 ENGINEER OF SAFETY ENGINEERING
 APPROVED April 11, 2016
 ENGINEER OF DESIGN AND ENVIRONMENT

ISSUED 1-1-97

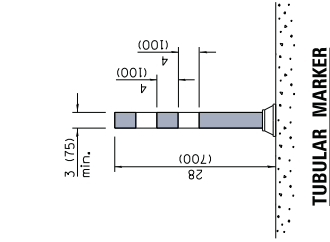
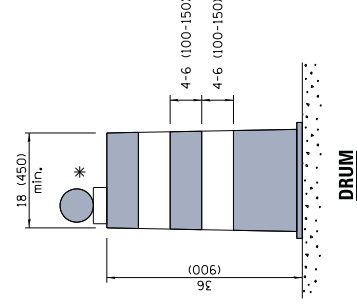
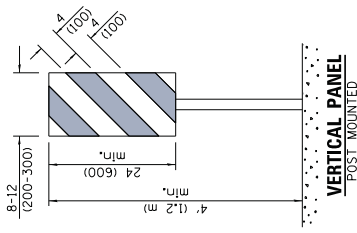
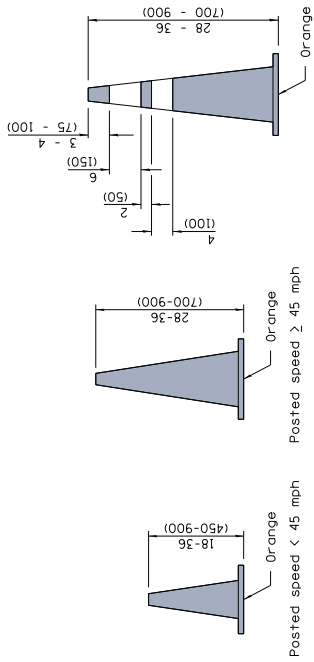

REFLECTORIZED CONE FOR NIGHTTIME

ORANGE CONE FOR DAYTIME

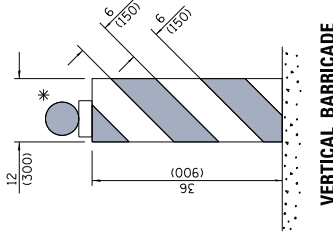
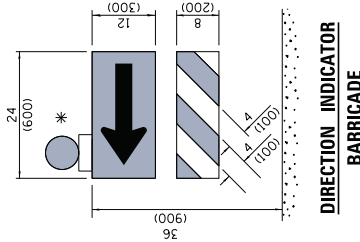
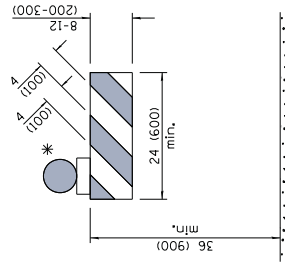
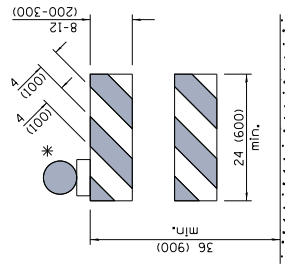
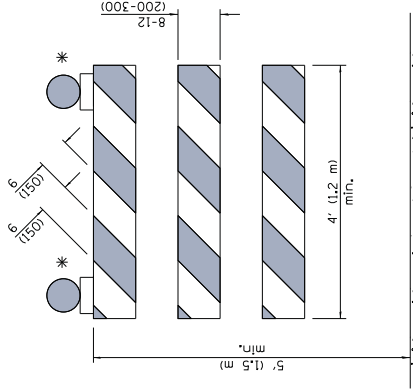

TYPE I BARRICADE

TYPE II BARRICADE

TYPE III BARRICADE

DIRECTION INDICATOR BARRICADE

VERTICAL BARRICADE

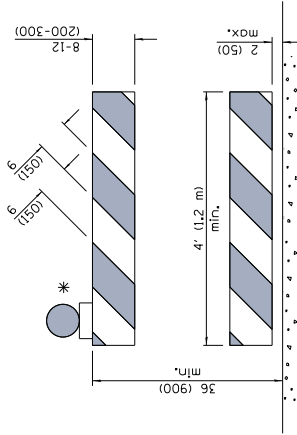

* Warning lights (if required)

GENERAL NOTES
All heights shown shall be measured above the pavement surface.
All dimensions are in inches (millimeters) unless otherwise shown.

DATE	REVISIONS
1-1-17	Changed FLEXIBLE DELINEATOR TO TUBULAR MARKER.
4-1-16	Add dims to barricades. Rev. note for post mnt. signs.
	Rev. cone dths. Add W2-I103.

DETECTABLE PEDESTRIAN CHANNELIZING BARRICADE

APPROVED	JANUARY 1, 2017	ISSUED	1-1-97
ENGINEER OF OPERATIONS	<i>[Signature]</i>		
APPROVED	JANUARY 1, 2017		
ENGINEER OF DESIGN AND ENVIRONMENT	<i>[Signature]</i>		

TRAFFIC CONTROL DEVICES

STANDARD 701901-06
(Sheet 1 of 3)

ROAD CONSTRUCTION NEXT X MILES
G20-1104(O)-6036

END CONSTRUCTION
G20-1105(O)-6024

This signing is required for all projects 2 miles (3200 m) or more in length.

ROAD CONSTRUCTION NEXT X MILES sign shall be placed 500' (150 m) in advance of project limits.

END CONSTRUCTION sign shall be erected at the end of the job unless another job is within 2 miles (3200 m).

Dual sign displays shall be utilized on multi-lane highways.

18x18 (450x450) Orange flags

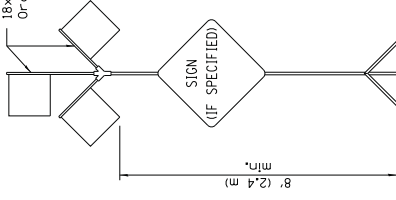

WORK LIMIT SIGNING

WORK ZONE SPEED LIMIT
W21-1105(O)-3618

PHOTO ENFORCED
R2-1-3648

SXXX FINE MINIMUM
R2-1106p-3618

END WORK ZONE SPEED LIMIT
G20-1103(O)-6036

Sign assembly as shown on Standards or as allowed by District Operations.

This sign shall be used when the above sign assembly is used.

HIGHWAY CONSTRUCTION SPEED ZONE SIGNS

.... R10-1108p shall only be used along roadways under the jurisdiction of the State.

HIGH LEVEL WARNING DEVICE

... When work operations exceed four days, this dimension shall be 5' (1.5 m) min. If located behind other devices, the height shall be sufficient to be seen completely above the devices.

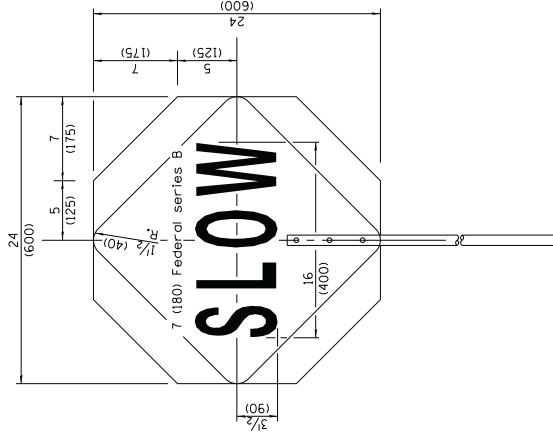

SIGNS ON TEMPORARY SUPPORTS

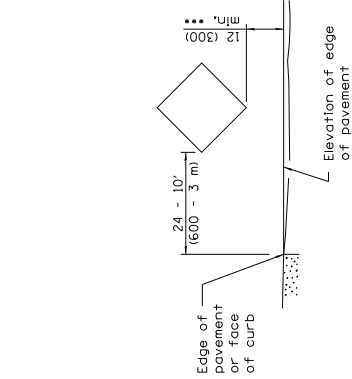

POST MOUNTED SIGNS

.. When curb or paved shoulder are present this dimension shall be 24 (600) to the face of curb or 6' (1.8 m) to the outside edge of the paved shoulder.

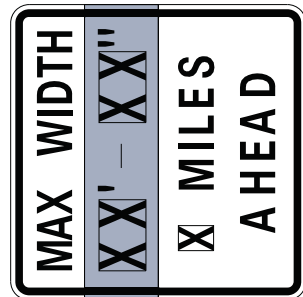
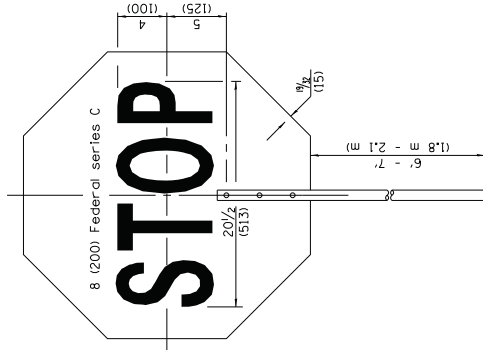
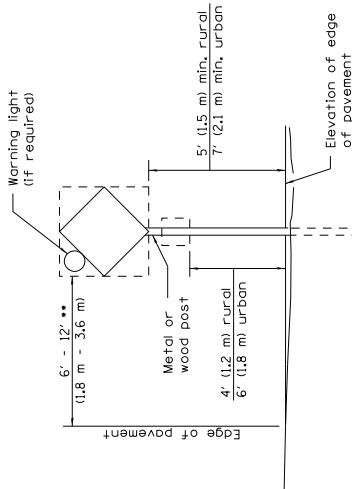

W12-1103-4848

WIDTH RESTRICTION SIGN

XX'-XX'' width and X miles are variable.

REVERSE SIDE

FRONT SIDE

FLAGGER TRAFFIC CONTROL SIGN

TRAFFIC CONTROL DEVICES

(Sheet 2 of 3)

STANDARD 701901-06

Illinois Department of Transportation

APPROVED JANUARY 1, 2017
ENGINEER OF OPERATIONS *John Kelly*

APPROVED JANUARY 1, 2017
ENGINEER OF DESIGN AND ENVIRONMENT *Thomas J. Kelly*

ISSUED 1-1-97

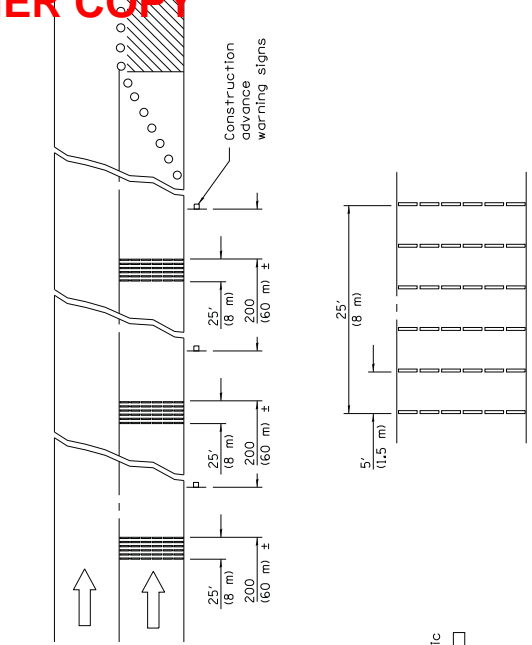

TYPICAL INSTALLATION

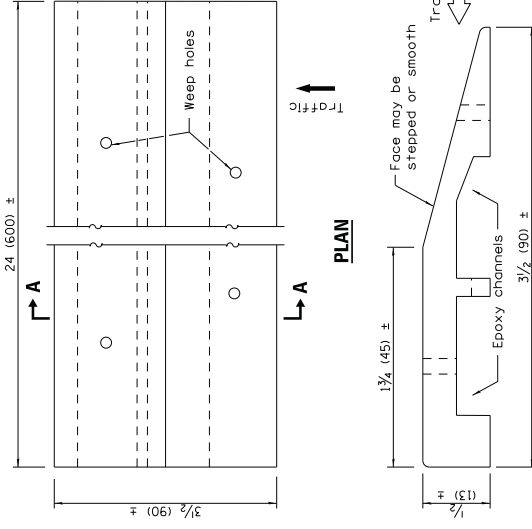

SECTION A-A

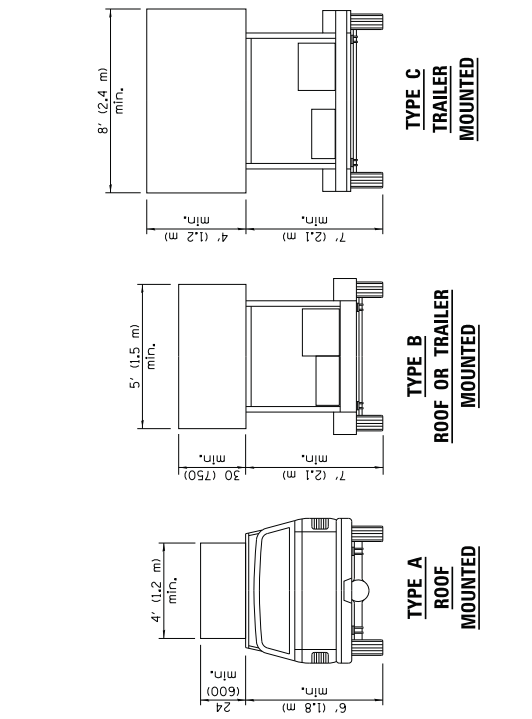

ARROW BOARDS

TEMPORARY RUMBLE STRIPS

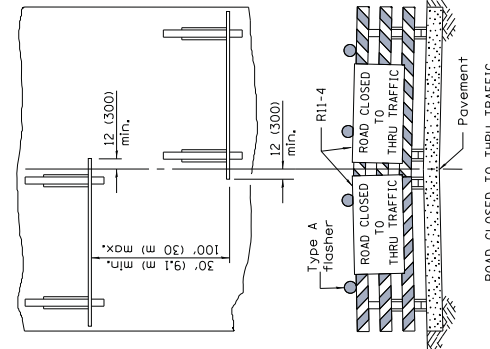

SECTION A-A

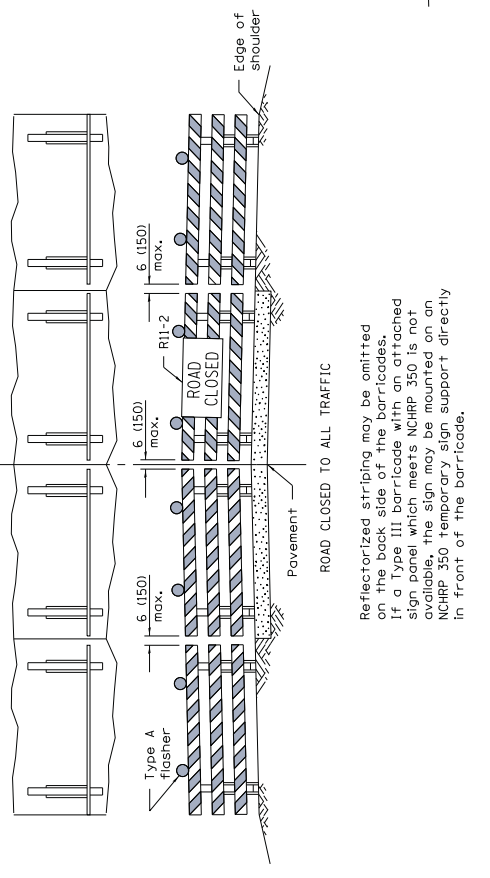

TYPICAL APPLICATIONS OF TYPE III BARRICADES CLOSING A ROAD

ReflectORIZED striping may be omitted on the back side of the barricades. If a Type III barricade with an attached sign panel which meets NCHRP 350 is not available, the sign may be mounted on an NCHRP 350 temporary sign support directly in front of the barricade.

ROAD CLOSED TO THRU TRAFFIC
ReflectORIZED striping shall appear on both sides of the barricades. If a Type III barricade with an attached sign panel which meets NCHRP 350 is not available, the signs may be mounted on NCHRP 350 temporary sign supports directly in front of the barricade.

TRAFFIC CONTROL DEVICES

STANDARD 701901-06

APPROVED ENGINEER OF OPERATIONS APPROVED ENGINEER OF DESIGN AND ENVIRONMENT	JANUARY 1, 2017 APPROVED JANUARY 1, 2017	ISSUED 1-1-97
--	--	---------------

OWNER COPY

CONTRACT

**JACKSON POND OVERFLOW PROJECT
VILLAGE OF VILLA PARK**

APPENDIX E

**STORMWATER POLLUTION PREVENTION PLAN
NOTICE OF INTENT**

OWNER COPY

CONTRACT

NOTICE OF INTENT (NOI)
GENERAL PERMIT TO DISCHARGE STORM WATER
CONSTRUCTION SITE ACTIVITIES

OWNER INFORMATION

COMPANY/ OWNER NAME:	Village of Villa Park			OWNER TYPE: SELECT ONE City	MS4 Community <input type="checkbox"/> Yes <input type="checkbox"/> No
MAILING ADDRESS:	20 South Ardmore			PHONE:	Area Code (630) Number 834-8505 ext. xxx
CITY:	Villa Park	STATE:	IL	ZIP CODE:	60181
CONTACT PERSON:	Vydas Juskelis			FAX:	Area Code (630) Number 834-8509
				EMAIL: juskelis@invillapark.com	

CONTRACTOR INFORMATION

CONTRACTOR NAME:					
MAILING ADDRESS:				PHONE:	Area Code () Number ext.
CITY:				STATE:	ZIP CODE:

CONSTRUCTION SITE INFORMATION

SELECT ONE:	<input checked="" type="checkbox"/> NEW SITE <input type="checkbox"/> CHANGE OF INFORMATION FOR: ILR10										
PROJECT NAME:	Jackson Pond Overflow Project							COUNTY:	DuPage		
STREET ADDRESS/ LOCATION	Highridge Road and Ardmore Avenue					CITY:	Villa Park		IL	ZIP CODE:	60181
LATITUDE:	DEG.	MIN.	SEC.	LONGITUDE:	DEG.	MIN.	SEC.	SECTION:	TOWNSHIP:	RANGE:	
	41	52	0		87	58	45	S16	T39N	R11E	
APPROX CONST START DATE	APPROX CONST END DATE		TOTAL SIZE OF CONSTRUCTION SITE IN ACRES: <u>19.8</u>								
			If less than 1 acre, is site part of larger common plan of development? <input type="checkbox"/> YES <input type="checkbox"/> NO								

STORM WATER POLLUTION PREVENTION PLAN INFORMATION

HAS STORM WATER POLLUTION PREVENTION PLAN BEEN SUBMITTED TO AGENCY? <input type="checkbox"/> YES <input type="checkbox"/> NO (SUBMIT SWPPP ELECTRONICALLY TO: epa.constilr10swppp@illinois.gov)										
WILL STORM WATER POLLUTION PREVENTION PLAN BE AVAILABLE AT SITE? <input checked="" type="checkbox"/> YES <input type="checkbox"/> NO										
LOCATION OF SWPPP FOR VIEWING: ADDRESS: On site								CITY: Villa Park		
SWPPP CONTACT INFORMATION: NAME: TBD								INSPECTOR QUALIFICATIONS: SELECT ONE CPESC		
PHONE: ()			FAX: ()			EMAIL:				
PROJECT INSPECTOR, IF DIFFERENT THAN ABOVE: NAME:								INSPECTOR QUALIFICATIONS: SELECT ONE Other		
PHONE: ()			FAX: ()			EMAIL:				

**NOTICE OF INTENT (NOI)
GENERAL PERMIT TO DISCHARGE STORM WATER
CONSTRUCTION SITE ACTIVITIES**

TYPE OF CONSTRUCTION (SELECT ALL THAT APPLY)

SELECT ONE OTHER	SIC Code:
TYPE DETAILED DESCRIPTION OF PROJECT: Mass excavation and site grading for flood control basin, ball field improvement, and installation of storm sewer discharging at Sugar Creek	

HISTORIC PRESERVATION AND ENDANGERED SPECIES COMPLIANCE

HAS THIS PROJECT BEEN SUBMITTED TO THE FOLLOWING STATE AGENCIES TO SATISFY APPLICABLE REQUIREMENTS FOR COMPLIANCE WITH ILLINOIS LAW ON:	
HISTORIC PRESERVATION	<input checked="" type="checkbox"/> YES <input type="checkbox"/> NO http://www.illinoishistory.gov/PS/rcdocument.htm
ENDANGERED SPECIES	<input checked="" type="checkbox"/> YES <input type="checkbox"/> NO http://dnrecocat.state.il.us/ecopublic/

RECEIVING WATER INFORMATION

DOES YOUR STORM WATER DISCHARGE DIRECTLY TO: <input checked="" type="checkbox"/> WATERS OF THE STATE OR <input type="checkbox"/> STORM SEWER
OWNER TO STORM SEWER SYSTEMS: n/a
NAME OF CLOSEST RECEIVING WATERBODY TO WHICH YOU DISCHARGE: Sugar Creek

I certify under penalty of law that this document and all attachments were prepared under my direction and supervision in accordance with a system designed to assure that qualified personnel properly gather and evaluate the information submitted. Based on my inquiry of the person or persons who manage this system, or those persons directly responsible for gathering the information, the information submitted is, to the best of my knowledge and belief, true, accurate, and complete. I am aware that there are significant penalties for submitting false information, including the possibility of fine and imprisonment. In addition, I certify that the provisions of the permit, including the development and implementation of a storm water pollution prevention plan and a monitoring program plan, will be complied with.

OWNER SIGNATURE: _____

DATE: _____

SUBMIT ELECTRONICALLY TO:
epa.constilr10swppp@illinois.gov

OR MAIL COMPLETED FROM TO:

ILLINOIS ENVIRONMENTAL PROTECTION AGENCY
 DIVISION OF WATER POLLUTION CONTROL
 ATTN: PERMIT SECTION
 POST OFFICE BOX 19276
 SPRINGFIELD, ILLINOIS 62794-9276
www.epa.state.il.us

FOR OFFICE USE ONLY
LOG:
PERMIT NO. ILR10 _____
DATE:

Information required by this form must be provided to comply with 415 ILCS 5/39 (1996). Failure to do so may prevent this form from being processed and could result in your application being denied. This form has been approved by the Forms Management Center.

IL 532 2104
WPC 623 Rev. 8/08

Submit form

Please adhere to the following instructions:

Submit original, electronic or facsimile copies. Facsimile and/or electronic copies should be followed-up with an original signature copy as soon as possible. Please write "copy" under the "For Office Use Only" box in the lower right hand corner.

< **Submit completed forms to:**

Illinois Environmental Protection Agency
Division of Water Pollution Control
Permit Section
Post Office Box 19276
Springfield, Illinois 62794-9276
or call (217)782-0610
www.epa.state.il.us

< **Reports must be typed or printed legibly and signed.**

< Any facility that is not presently covered by the General NPDES Permit for Storm Water Discharges From Construction Site Activities is considered a new facility.

< **If this is a change in your facility information, renewal, etc., please fill in your permit number on the appropriate line, changes of information or permit renewal notifications do not require a fee.**

< **NOTE: FACILITY LOCATION IS NOT NECESSARILY THE FACILITY MAILING ADDRESS, BUT SHOULD DESCRIBE WHERE THE FACILITY IS LOCATED.**

< **Use the formats given in the following examples for correct form completion.**

	<u>Example</u>	<u>Format</u>
SECTION	12	1 or 2 numerical digits
TOWNSHIP	12N	1 or 2 numerical digits followed by "N" or "S"
RANGE	12W	1 or 2 numerical digits followed by "E" or "W"

< **For the Name of Closest Receiving Waters, do not use terms such as ditch or channel. For unnamed tributaries, use terms which include at least a named main tributary such as "Unnamed Tributary to Sugar Creek to Sangamon River."**

< **Submit a fee of \$500 and the Storm Water Pollution Plan (SWPPP) for initial permit prior to the Notice of Intent being considered complete for coverage by the ILR10 General Permits. Please make checks payable to: Illinois EPA.**

< **SWPPP should be submitted electronically to: epa.constilr10swppp@illinois.gov When submitting electronically, use Project Name and City as indicated on NOI form.**



Storm Water Pollution Prevention Plan

Print Form E-mail Reset Form

Route: Jackson Pond Overflow; Marked Route: West Highridge Road; Section: N/A; Project Number; County: DuPage; Contract Number

This plan has been prepared to comply with the provisions of the National Pollutant Discharge Elimination System (NPDES) Permit No. ILR10 (Permit ILR10), issues by the Illinois Environmental Protection Agency (IEPA) for storm water discharges from construction site activities.

I certify under penalty of law that this document and all attachments were prepared under my direction or supervision in accordance with a system designed to assure that qualified personnel properly gathered and evaluated the information submitted.

Print Name: Vydas Juskelis; Title: Director of Public Works; Agency: Village of Villa Park; Signature; Date

I. Site Description

- A. Provide a description of the project location (include latitude and longitude): West Highridge Road from Jackson Middle School to Ardmore Avenue (41 52' 0" N, 87 58' 45" W).
B. Provide a description of the construction activity which is subject of this plan: Swale and basin excavation, storm sewer installation and connection to Sugar Creek
C. Provide the estimated duration of this project: 6 months.
D. The total area of the construction site is estimated 19.8 acres. The total area of the site estimated to be disturbed by excavation, grading or other 8 acres.
E. The following is a weighted average of the runoff coefficient for this project after construction activities are completed: 0.48
F. List all soils found within project boundaries. Include map unit name, slope information and erosivity: See attached exhibit 1F
G. Provide an aerial extent of wetland acreage at the site: See attached exhibit 1G
H. Provide a description of potentially erosive areas associated with this project: Excavations and parkways.
I. The following is a description of soil disturbing activities by stages, their locations, and their erosive factors (e.g. steepness of slopes, length of scopes, etc.):



Print Form

E-mail

Reset Form

After removing the existing pavement and excavating for the storm sewer construction, the exposed soil will be susceptible to erosion from storm events. Foreslopes that drain away from the road are slopes of 10:1 or flatter to the ROW.

J. See the erosion control plans and/or drainage plans for this contract for information regarding drainage patterns, approximate slopes anticipated before and after major grading activities, locations where vehicles enter or exit the site and controls to prevent off site sediment tracking (to be added after contractor identifies locations), areas of soil disturbance, the location of major structural and non-structural controls identified in the plan, the location of areas where stabilization practices are expected to occur, surface waters (including wetlands) and locations where storm water is discharged to surface water including wetlands.

K. Identify who owns the drainage system (municipality or agency) this project will drain into:

Village of Villa Park

L. The following is a list of General NPDES ILR40 permittees within whose reporting jurisdiction this project is located.

M. The following is a list of receiving water(s) and the ultimate receiving water(s) for this site. The location of the receiving waters can be found on the erosion and sediment control plans:

Runoff is tributary to Jackson detention basin and storm sewers which discharge into Sugar Creek.

N. Describe areas of the site that are to be protected or remain undisturbed. These areas may include steep slopes, highly erodible soils, streams, stream buffers, specimen trees, natural vegetation, nature preserves, etc.

None

O. The following sensitive environmental resources are associated with this project, and may have the potential to be impacted by the proposed development:

- Floodplain
Wetland Riparian
Threatened and Endangered Species
Historic Preservation
303(d) Listed receiving waters for suspended solids, turbidity, or siltation
Receiving waters with Total Maximum Daily Load (TMDL) for sediment, total suspended solids, turbidity, or siltation
Applicable Federal, Tribal, State or Local Programs
Other

303(d) Listed receiving waters (fill out this section if checked above):

a. The name(s) of the listed water body, and identification of all pollutants causing impairment:

b. Provide a description of how erosion and sediment control practices will prevent a discharge of sediment resulting from a storm event equal to or greater than a twenty-five (25) year, twenty-four (24) hour rainfall event:

c. Provide a description of the location(s) of direct discharge from the project site to the 303(d) water body:

d. Provide a description of the location(s) of any dewatering discharges to the MS4 and/or water body:



Storm Water Pollution Prevention Plan

Print Form

E-mail

Reset Form

2. TMDL (fill out this section if checked above)

a. The name(s) of the listed water body:

[Empty text box for water body name]

b. Provide a description of the erosion and sediment control strategy that will be incorporated into the site design that is consistent with the assumptions and requirements of the TMDL:

[Empty text box for erosion and sediment control strategy]

c. If a specific numeric waste load allocation has been established that would apply to the project's discharges, provide a description of the necessary steps to meet the allocation:

[Empty text box for waste load allocation description]

P. The following pollutants of concern will be associated with this construction project:

- Soil Sediment
- Concrete
- Concrete Truck waste
- Concrete Curing Compounds
- Solid waste Debris
- Paints
- Solvents
- Fertilizers / Pesticides
- Petroleum (gas, diesel, oil, kerosene, hydraulic oil / fluids)
- Antifreeze / Coolants
- Waste water from cleaning construction equipment
- Other (specify) _____
- Other (specify) _____
- Other (specify) _____
- Other (specify) _____
- Other (specify) _____

II. Controls

This section of the plan addresses the controls that will be implemented for each of the major construction activities described in I.C. above and for all use areas, borrow sites, and waste sites. For each measure discussed, the Contractor will be responsible for its implementation as indicated. The Contractor shall provide to the Resident Engineer a plan for the implementation of the measures indicated. The Contractor and subcontractors, will notify the Resident Engineer of any proposed changes, maintenance, or modifications to keep construction activities compliant with the Permit ILR10. Each such Contractor has signed the required certification on forms which are attached to, and are a part of, this plan:

A. Erosion and Sediment Controls: At a minimum, controls must be coordinated, installed, and maintained to:

B. Stabilization Practices: Provided below is a description of interim and permanent stabilization practices, including

site- specific scheduling of the implementation of the practices. Site plans will ensure that existing vegetation is preserved where attainable and disturbed portions of the site will be stabilized. Stabilization practices may include but are not limited to: temporary seeding, permanent seeding, mulching, geotextiles, sodding, vegetative buffer strips, protection of trees, preservation of mature vegetation, and other appropriate measures. Except as provided below in II(B)(1) and II(B)(2), stabilization measures shall be initiated immediately where construction activities have temporarily or permanently ceased, but in no case more than one (1) day after the construction activity in that portion of the site has temporarily or permanently ceases on all disturbed portions of the site where construction will not occur for a period of fourteen (14) or more calendar days.

1. Where the initiation of stabilization measures is precluded by snow cover, stabilization measures shall be initiated as soon as practicable.



Storm Water Pollution Prevention Plan

Print Form

E-mail

Reset Form

- 2. On areas where construction activity has temporarily ceased and will resume after fourteen (14) days, a temporary stabilization method can be used.

The following stabilization practices will be used for this project:

- | | |
|---|--|
| <input checked="" type="checkbox"/> Preservation of Mature Vegetation | <input checked="" type="checkbox"/> Erosion Control Blanket / Mulching |
| <input type="checkbox"/> Vegetated Buffer Strips | <input checked="" type="checkbox"/> Sodding |
| <input checked="" type="checkbox"/> Protection of Trees | <input checked="" type="checkbox"/> Geotextiles |
| <input checked="" type="checkbox"/> Temporary Erosion Control Seeding | <input type="checkbox"/> Other (specify) _____ |
| <input type="checkbox"/> Temporary Turf (Seeding, Class 7) | <input type="checkbox"/> Other (specify) _____ |
| <input type="checkbox"/> Temporary Mulching | <input type="checkbox"/> Other (specify) _____ |
| <input checked="" type="checkbox"/> Permanent Seeding | <input type="checkbox"/> Other (specify) _____ |

Describe how the stabilization practices listed above will be utilized during construction:

Silt fence will be placed around construction area prior to excavation. Tree protection will be used where necessary. Areas outside the pavement will be permanently stabilized with seed or sod after construction of roadway items and sidewalk is completed. +

Describe how the stabilization practices listed above will be utilized after construction activities have been completed:

Erosion control blankets will be placed until the sod has established as stabilized vegetation. Temporary measures will be removed once vegetation has established. +

- C. **Structural Practices:** Provided below is a description of structural practices that will be implemented, to the degree attainable, to divert flows from exposed soils, store flows or otherwise limit runoff and the discharge of pollutants from exposed areas of the site. Such practices may include but are not limited to: perimeter erosion barrier, earth dikes, drainage swales, sediment traps, ditch checks, subsurface drains, pipe slope drains, level spreaders, storm drain inlet protection, rock outlet protection, reinforced soil retaining systems, gabions, and temporary or permanent sediment basins. The installation of these devices may be subject to Section 404 of the Clean Water Act.

The following stabilization practices will be used for this project:

- | | |
|---|--|
| <input checked="" type="checkbox"/> Perimeter Erosion Barrier | <input checked="" type="checkbox"/> Rock Outlet Protection |
| <input type="checkbox"/> Temporary Ditch Check | <input checked="" type="checkbox"/> Riprap |
| <input checked="" type="checkbox"/> Storm Drain Inlet Protection | <input type="checkbox"/> Gabions |
| <input type="checkbox"/> Sediment Trap | <input type="checkbox"/> Slope Mattress |
| <input type="checkbox"/> Temporary Pipe Slope Drain | <input type="checkbox"/> Retaining Walls |
| <input type="checkbox"/> Temporary Sediment Basin | <input type="checkbox"/> Slope Walls |
| <input type="checkbox"/> Temporary Stream Crossing | <input type="checkbox"/> Concrete Revetment Mats |
| <input checked="" type="checkbox"/> Stabilized Construction Exits | <input type="checkbox"/> Level Spreaders |
| <input type="checkbox"/> Turf Reinforcement Mats | <input type="checkbox"/> Other (specify) _____ |
| <input type="checkbox"/> Permanent Check Dams | <input type="checkbox"/> Other (specify) _____ |
| <input type="checkbox"/> Permanent Sediment Basin | <input type="checkbox"/> Other (specify) _____ |
| <input type="checkbox"/> Aggregate Ditch | <input type="checkbox"/> Other (specify) _____ |
| <input type="checkbox"/> Paved Ditch | <input type="checkbox"/> Other (specify) _____ |

Describe how the structural practices listed above will be utilized during construction:



Print Form

E-mail

Reset Form

Perimeter erosion barrier will be placed in areas sloping away from the project. Storm structures within the work area and adjacent to the work area will be protected with inlet filters and culvert protection. +

Describe how the structural practices listed above will be utilized after construction activities have been completed:

The structural practices listed will remain in place until the grass has established as stabilized +

D. Treatment Chemicals

Will polymer flocculents or treatment chemicals be utilized on this project: Yes No

If yes above, identify where and how polymer flocculents or treatment chemicals will be utilized on this project.

E. Permanent Storm Water Management Controls:

Provided below is a description of measures that will be installed during the construction process to control volume and pollutants in storm water discharges that will occur after construction operations have been completed. The installation of these devices may be subject to Section 404 of the Clean Water act.

- Such practices may include but are not limited to: storm water detention structures (including wet ponds), storm water retention structures, flow attenuation by use of open vegetated swales and natural depressions, infiltration of runoff on site, and sequential systems (which combine several practices).
The practices selected for implementation were determined on the basis of the technical guidance in Chapter 41 (Construction Site Storm Water Pollution Control) of the IDOT Bureau of Design & Environment Manual. If practices other than those discussed in Chapter 41 are selected for implementation or if practices are applied to situations different from those covered in Chapter 41, the technical basis for such decisions will be explained below.
- Velocity dissipation devices will be placed at discharge locations and along the length of any outfall channel as necessary to provide a non-erosive velocity flow from the structure to a water course so that the natural physical and biological characteristics and functions are maintained and protected (e.g. maintenance of hydrologic conditions such as the hydroperiod and hydrodynamics present prior to the initiation of construction activities).

Description of permanent storm water management controls:

Runoff from the project areas will be directed to the Jackson detention basin. No outfall protection is required for this project. +

F. Approved State or Local Laws:

The management practices, controls, and provisions contained in this plan will be in accordance with IDOT specifications, which are at least as protective as the requirements contained in the Illinois Environmental Protection Agency's Illinois Urban Manual. Procedures and requirements specified in applicable sediment and erosion site plans or storm water management plans approved by local officials shall be described or incorporated by reference in the space provided below. Requirements specified in sediment and erosion site plans, site permits, storm water management site plans or site permits approved by local officials that are applicable to protecting surface water resources are, upon submittal of an NOI, to be authorized to discharge under the Permit ILR10 incorporated by reference and are enforceable under this permit even if they are not specifically included in the plan.

Description of procedures and requirements specified in applicable sediment and erosion site plans or storm water management plans approved by local officials:

All management practices, controls, and other provisions provided in this plan are in accordance with IDOT Standard Specifications for Road and Bridge Construction. +

G. Contractor Required Submittals:

Prior to conducting any professional services at the site covered by this plan, the Contractor and each subcontractor responsible for compliance with the permit shall submit to the Resident Engineer a Contractor Certification Statement, BDE 2342a.

- The Contractor shall provide a construction schedule containing an adequate level of detail to show major activities with implementation of pollution prevention BMPs, including the following items:



Print Form

E-mail

Reset Form

2. The Contractor and each subcontractor shall provide, as an attachment to their signed Contractor Certification Statement, a discussion of how they will comply with the requirements of the permit in regard to the following items and provide a graphical representation showing location and type of BMPs to be used when applicable:

III. Maintenance

When requested by the Contractor, the Resident Engineer will provide general maintenance guides to the Contractor for the practices associated with this project. The following additional procedures will be used to maintain, in good and effective operating conditions, the vegetation, erosion and sediment control measures and other protective measures identified in this plan. It will be Contractor's responsibility to attain maintenance guidelines for any manufactured BMPs which are to be installed and maintained per manufacture's specifications.

Erosion and sediment control measures should be inspected at least once a week and after any rainfall event of greater than 0.5 inches or equivalent snowfall. The contractor is responsible for maintenance of the erosion control system. 

IV. Inspections



Storm Water Pollution Prevention Plan

Print Form

E-mail

Reset Form

Qualified personnel shall inspect disturbed areas of the construction site which have not yet been finally stabilized, structural control measures, and locations where vehicles and equipment enter and exit the site using IDOT Storm Water Pollution Prevention Plan Erosion Control Inspection Report (BC 2259). Such inspections shall be conducted at least once every seven (7) calendar days and within twenty-four (24) hours of the end of a storm or by the end of the following business or work day that is 0.5 inch or greater or equivalent snowfall.

Inspections may be reduced to once per month when construction activities have ceased due to frozen conditions. Weekly inspections will recommence when construction activities are conducted, or if there is 0.5" or greater rain event, or a discharge due to snowmelt occurs.

If any violation of the provisions of this plan is identified during the conduct of the construction work covered by this plan, the Resident Engineer shall notify the appropriate IEPA Field Operations Section office by e-mail at: , telephone or fax within twenty-four (24) hours of the incident. The Resident Engineer shall then complete and submit an "Incidence of Non-Compliance" (ION) report for the identified violation within five (5) days of the incident. The Resident Engineer shall use forms provided by IEPA and shall include specific information on the cause of noncompliance, actions which were taken to prevent any further causes of noncompliance, and a statement detailing any environmental impact which may have resulted from the noncompliance. All reports of non-compliance shall be signed by a responsible authority in accordance with Part VI. G of the Permit ILR10.

The Incidence of Non-Compliance shall be mailed to the following address:

Illinois Environmental Protection Agency
Division of Water Pollution Control
Attn: Compliance Assurance Section
1021 North Grand East
Post Office Box 19276
Springfield, Illinois 62794-9276

Additional Inspections Required:

V. Failure to Comply

Failure to comply with any provisions of this Storm Water Pollution Prevention Plan will result in the implementation of a National Pollutant Discharge Elimination System/Erosion and Sediment Control Deficiency Deduction against the Contractor and/or penalties under the Permit ILR10 which could be passed on to the Contractor.

Contractor Certification Statement

Reset Form

Prior to conducting any professional services at the site covered by this contract, the Contractor and every subcontractor must complete and return to the Resident Engineer the following certification. A separate certification must be submitted by each firm. Attach to this certification all items required by Section II.G of the Storm Water Pollution Prevention Plan (SWPPP) which will be handled by the Contractors/subcontractor completing this form.

Route	Marked Route	Section
Jackson Pond Overflow	West Highridge Road	N/A
Project Number	County	Contract Number
	DuPage	

This certification statement is a part of SWPPP for the project described above, in accordance with the General NPDES Permit No. ILR10 issued by the Illinois Environmental Protection Agency.

I certify under penalty of law that I understand the terms of the Permit No. ILR10 that authorizes the storm water discharges associated with industrial activity from the construction site identified as part of this certification.

In addition, I have read and understand all of the information and requirements stated in SWPPP for the above mentioned project; I have received copies of all appropriate maintenance procedures; and, I have provided all documentation required to be in compliance with the Permit ILR10 and SWPPP and will provide timely updates to these documents as necessary.

- Contractor
- Sub-Contractor

Print Name	Signature
Title	Date
Name of Firm	Telephone
Street Address	City/State/Zip

Items which the Contractor/subcontractor will be responsible for as required in Section II.G. of SWPPP:

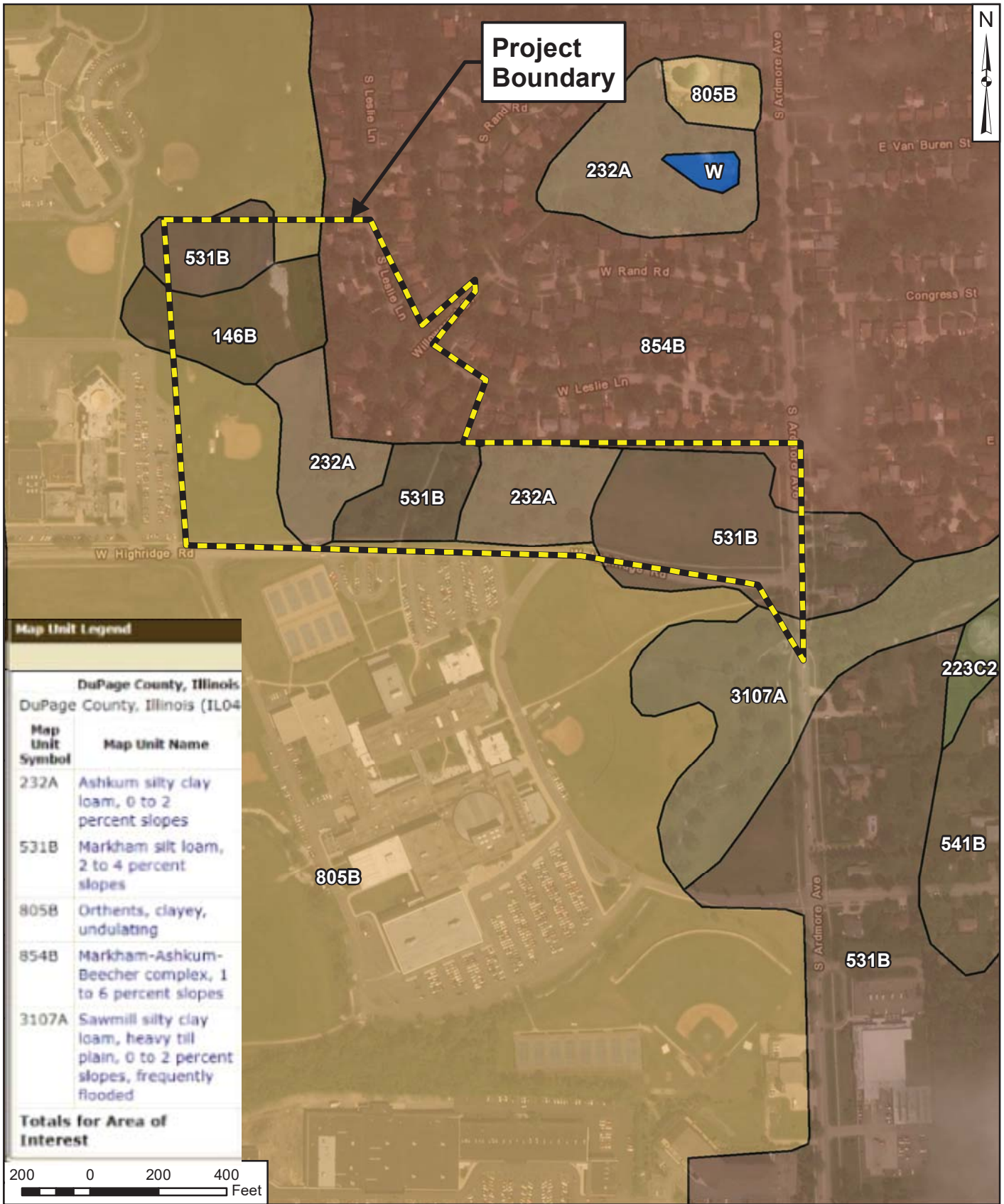

Map Unit Legend	
DuPage County, Illinois	
DuPage County, Illinois (IL04)	
Map Unit Symbol	Map Unit Name
232A	Ashkum silty clay loam, 0 to 2 percent slopes
531B	Markham silt loam, 2 to 4 percent slopes
805B	Orthents, clayey, undulating
854B	Markham-Ashkum-Beecher complex, 1 to 6 percent slopes
3107A	Sawmill silty clay loam, heavy till plain, 0 to 2 percent slopes, frequently flooded
Totals for Area of Interest	



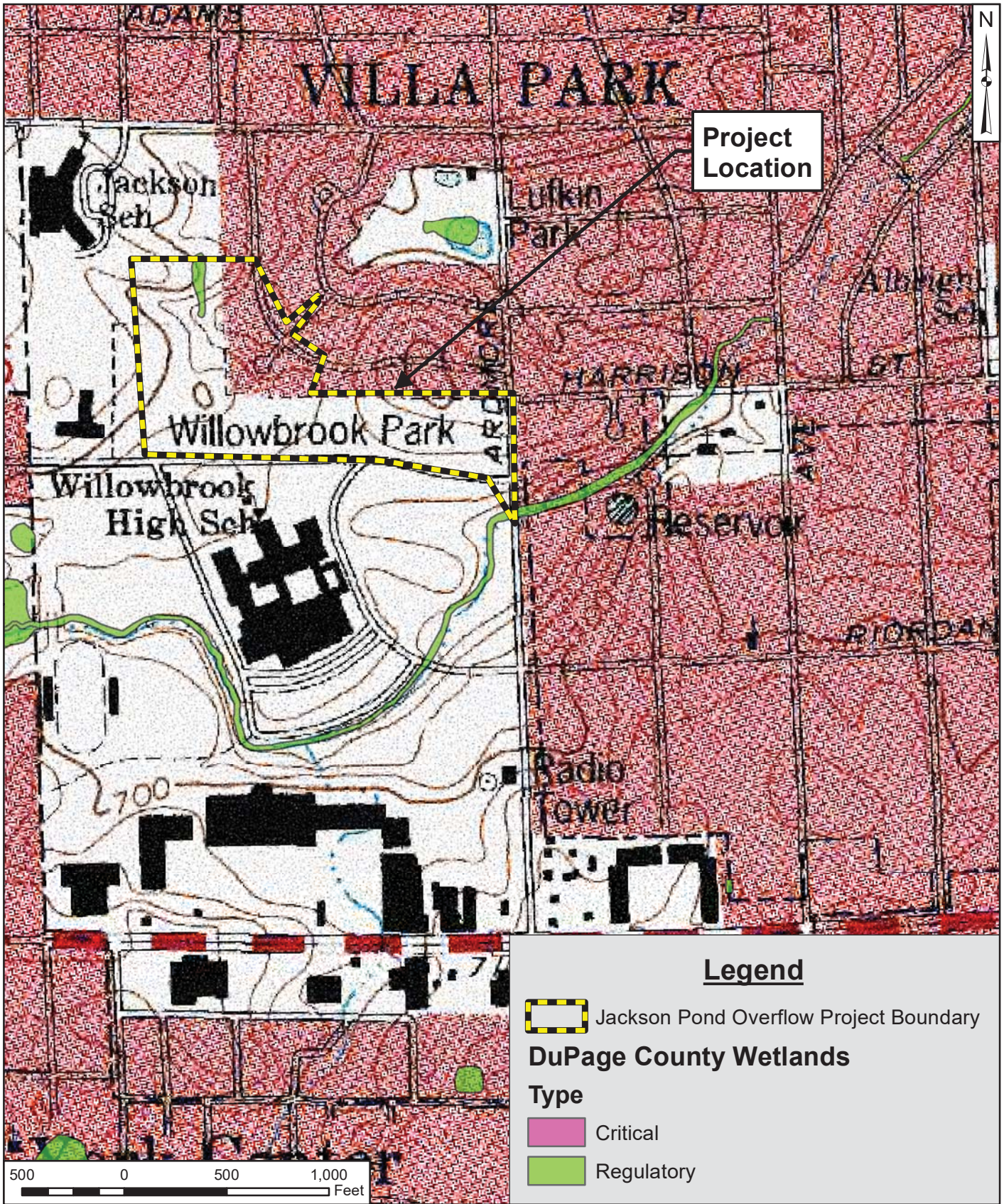

 <p>V3 Companies 7325 Janes Avenue Woodridge, Illinois 60517 630.724.9200 phone 630.724.9202 fax www.v3co.com</p>	<p>PROJECT NO.: 16296.Jackson</p>	<p>CLIENT:</p>	<p>TITLE: DUPAGE COUNTY SOILS MAP</p>
	<p>CREATED BY: LEH</p>	<p>DATE: 06/19/18</p>	<p>BASE LAYER: Soil Survey of DuPage County (2015)</p>
<p>Visio, Vertere, Virtute... "The Vision To Transform with Excellence"</p>	<p>SCALE: See Scale Bar</p>	<p>EXHIBIT: 1F</p>	



Project Location

Legend

-  Jackson Pond Overflow Project Boundary
- DuPage County Wetlands**
- Type**
-  Critical
-  Regulatory



 <p>V3 Companies 7325 Janes Avenue Woodridge, Illinois 60517 630.724.9200 phone 630.724.9202 fax www.v3co.com</p> <p>Visio, Vertere, Virtute... "The Vision To Transform with Excellence"</p>	<p>PROJECT NO.: 16295.JACKSON</p> <p>CREATED BY: LEH</p> <p>DATE: 04/30/18</p> <p>SCALE: See Scale Bar</p>	<p>CLIENT: Village of Villa Park 20 S Ardmore Ave Villa Park, IL, 60181</p> <p>BASE LAYER: USGS Topographic Map DuPage County Quadrangle</p>	<p>TITLE: DUPAGE COUNTY WETLANDS MAP</p> <p>SITE: Jackson Pond Overflow Project</p>	<p>EXHIBIT: 1G</p>
	<p>N:\2016\16295\16295.Jackson\Reports\NR\Water Resources\20180612 Bid Documents\Jackson Pond Overflow Project\Appendices\ArcGIS\Wetlands Map-Jackson.mxd</p>			

OWNER COPY

CONTRACT

APPENDIX F
FEDERAL REQUIREMENTS

OWNER COPY

CONTRACT

FEDERAL REQUIREMENTS



THIS BOOKLET IS BEING PROVIDED AS PART OF THE BID MANUAL FOR THIS PROJECT BECAUSE FEDERAL LABOR STANDARDS AND PREVAILING WAGE RATES WILL APPLY TO THIS PROJECT.

THIS BOOKLET CONTAINS:

- Required Contract Provisions for HUD Funded Capital projects in DuPage County, IllinoisPage 1
 - Executive Order 11246Page 13
 - HUD Federal Labor Standards ProvisionsPage 21
- HUD required general contractor and sub-contractor formsPage 26
 Samples and instructions for required contractor forms to be filled out, signed, and turned in by all labor providers, including:
 - Ownership FormPage 27
 - Letter to the Office of Federal Contract Compliance LaborPage 28
 - Labor Relations AgreementPage 29
 - Apprentive Policy Recognition FormPage 31
 - Section 3 FormsPage 32
 - Certified Payroll and Statement of CompliancePage 39
- A copy of the latest Davis Bacon Federal Wage determination for wage rates in DuPage CountyPage 47

Supplied through the DuPage
 Community Development Commission
 421 N. County Farm Road
 Wheaton, IL 60187

OWNER COPY

CONTRACT

**REQUIRED CONTRACT PROVISIONS FOR HUD FUNDED
CAPITAL PROJECTS IN DUPAGE COUNTY, ILLINOIS**

TABLE OF CONTENTS

I. Application..... 2

II. Equal Opportunity Provisions..... 2

III. Executive Order 11246 (Executive Order 11246 [Applicable to contractors/subcontractors exceeding \$10,000]) 3

IV. Notice of Requirement for Affirmative Action to Ensure Equal Employment Opportunity (Executive Order 11246 – Applicable to contractor/subcontracts exceeding \$10,000) 4

V. Standard Federal Equal Employment Opportunity Construction Contract Specifications (Executive Order 1246) 5

 A. As Used in these specifications 5

 B. “Minority” Includes 5

 C. Subcontracts..... 5

 D. Equal Employment Opportunity Documentation 6

 E. Voluntary Associations 8

 F. Civil Rights Act of 1964..... 9

 G. Section 109 of the Housing and Community Development Act of 1974 9

 H. “Section 3” Compliance in the Provision of Training, Employment and Business Opportunities..... 9

VI. Contract Work Hours and Safety Standards 10

 A. Overtime Requirements..... 11

 B. Violation and Liability for Unpaid Wages and Liquidated Damages..... 11

 C. Withholding for Unpaid Wages and Liquidated Damages 11

 D. Subcontract 11

 E. Contractor’s Responsibility 11

VII. Safety 11

VIII. False Statements Concerning Projects 11

IX. Implementation of Clean Air Act..... 12

X. Labor Standards 12

I. APPLICATION

- A. These *Required Contract Provisions* shall apply to all work performed on the contract by the Contractor with his own organization and with the assistance of workmen under his immediate superintendence and to all work performed on the contract by piece work, station work or by subcontract.
- B. The Contractor shall insert in each of his subcontracts all of the stipulations contained in these *Required Contract Provisions* and also a clause requiring his Subcontractors to include these *Required Contract Provisions* in any lower tier subcontracts which they may enter into, together with a clause requiring the inclusion of these provisions in any further subcontracts that may in turn be made. The *Required Contract Provisions* shall in no instance be incorporated by reference.
- C. A breach of any of the stipulations contained in these *Required Contract Provisions* may be grounds for termination of the contract.
- D. A breach of the following clauses may also be grounds for debarment as provided in 29 CFR, Part 5.6.
- E. All Bidders must sign the CDC Conditions and submit them with their complete bid package. This form is found in the Bid Specifications Manual.
- F. All bidders and their subcontractor shall be eligible for award of a federally assisted or insured contract. Should any subcontractor be found ineligible after award of a contract, its contract shall be terminated and the matter referred to the Department of Labor for its action.

II. EQUAL OPPORTUNITY PROVISIONS

A. *Equal Opportunity Clause*

Except as otherwise provided, DuPage County requires the inclusion of the following language as a condition of any grant, contract, loan insurance or guarantee involving federally assisted construction which is not exempt from the requirements of equal opportunity. The subgrantee hereby agrees that it will incorporate or cause to be incorporated into any contract for construction work, or modification thereof, as defined in the regulations of the Secretary of Labor at 41 CFR, Part 60, which is paid for in whole or in part with funds obtained from the Federal Government or borrowed on the credit of the Federal Government pursuant to a grant, contract, loan insurance or guarantee or undertaken pursuant to any Federal program involving such grant, contract, loan, insurance or guarantee, the following opportunity Clause:

B. *Activities and Contracts Not Subject to Executive Order 11246, As Amended (Applicable to federally assisted construction contracts and related subcontracts \$10,000 and under).*

During the performance of this contract, the Contractor agrees as follows,

“The Contractor shall not discriminate against any employee or applicant for employment because of race, color religion, sex or national origin. The Contractor shall take affirmative action to ensure that the applicants for employment are employed, and that employees are treated during employment, without regard to their race, color, religion, sex, or national origin.

Such action shall include, but not be limited to, the following; employment, upgrading, demotion or transfer; recruitment or recruitment advertising, layoff or termination; rates of pay or other forms of compensation and selection for training including apprenticeship. The Contractor shall post in conspicuous places, available to employees and applicants for employment, notices to be provided by the DuPage County Community Development Specialist setting forth the provisions of this nondiscrimination clause. The contractor shall state that all qualified applicants will receive consideration for employment without regard to race, color, religion, sex or national origin”.

Contractors shall incorporate foregoing requirements in all subcontracts.

III. EXECUTIVE ORDER 11246 - Equal Employment Opportunity

Contracts/Subcontracts above \$10,000 Section 202 Equal Opportunity Clause

The complete Executive Order 11246 is included in this Federal Requirements booklet.

A. During the performance of this contract, the Contractor agrees as follows,

“The Contractor will not discriminate against any employee or applicant for employment because of race, color, religion, sex or national origin. The Contractor will take affirmative action to ensure that applicants are employed, and employees are treated during employment, without regard to their race, color, religion, sex or national origin. Such action shall include but not be limited to the following: employment, upgrading, demotion or transfer, recruitment or recruitment advertising, layoff or termination, rates of pay or other forms of compensation and selection for training, including apprenticeship. The Contractor agrees to post in conspicuous places, available to employees and applicants for employment, notices to be provided setting forth the provisions of this nondiscrimination clause”.

B. The Contractor will, in all solicitations or advertisements for employees placed by or on behalf of the Contractor, state that all qualified applicants will receive consideration for employment without regard to race, color, religion, sex or national origin.

C. The Contractor will send to each labor union or representative of workers with which he has a collective bargaining agreement or other contract or understanding, a notice to be provided by the Contract Compliance Officer advising the said labor union or worker’s representatives of the contractor’s commitment under this section, and shall post copies of the notice in conspicuous places available to employees and applicants for employment.

D. The Contractor will comply with all provisions of Executive Order 11246 of September 24, 1965, and of the rules, regulations and relevant orders of the Secretary of Labor.

E. The Contractor will furnish all information and reports required by Executive Order 11246 of September 24, 1965, and by rules, regulations and orders of the Secretary of Labor or pursuant thereto, and will permit access to his or her books, records and accounts by DuPage County, HUD and the Secretary of Labor for purposes of investigation to ascertain compliance with such rules, regulations and orders.

F. In the event of the Contractor’s noncompliance with the nondiscrimination clauses of this contract or with any of the said rules, regulations or orders, this contract may be canceled, terminated or suspended in whole or in part, and the Contractor may be declared ineligible for further Government contracts in accordance with procedures authorized in Executive

Order 11246 of September 24, 1965, or by rule, regulation or order of the Secretary of Labor or as otherwise provided by law.

- G. The Contractor will include the provisions of the sentence immediately preceding paragraph (1) and the provisions of paragraphs (A) through (G) in every subcontract or purchase order unless exempted by rules, regulations or orders of the Secretary of Labor issued pursuant to Section 204 of Executive Order 11246 of September 24, 1965, so that such provisions will be binding upon each subcontractor or vendor. The Contractor will take such action with respect to any subcontractor or purchase order as DuPage County or HUD may direct as means of enforcing such provisions, including sanctions for noncompliance. Provided, however, that in the event the Contractor becomes involved in or threatened with litigation with a subcontractor or vendor as a result of such direction by DuPage County or HUD, the Contractor may request the United States to enter into such litigation to protect the interest of the United States.

IV. NOTICE OF REQUIREMENT FOR AFFIRMATIVE ACTION TO ENSURE EQUAL EMPLOYMENT OPPORTUNITY (*Executive Order 11246, applicable to contracts/subcontracts exceeding \$10,000*)

- A. The Offeror or Bidder's attention is called the "Equal Opportunity Clause" and the "Standard Equal Employment Opportunity Construction Contract Specifications" set Herein.
- B. The goals and timetables for minority and female participation, expressed in percentage terms for the Contractor's aggregate workforce in each trade on all construction work in the covered area, are as follows:
 - 1. Until further notice the goal for women participation is 6.9% (Nationwide).
 - 2. Until further notice the goal for minority participation is 19.6% (Chicago PMSA).
- C. These goals are applicable to all Contractor's construction work (whether or not it is Federal or Federally assisted) performed in the covered area.
- D. The Contractor's compliance with the Executive Order and the regulations in 41 CFR, Part 60.4 shall be based on its implementation of the Equal Opportunity Clause, specific affirmative action obligations required by the specifications set forth in 41 CFR, Part 60-4.3(a), and its efforts to meet the goals established for the geographical area where the contract resulting from this solicitation is to be performed. The hours of minority and female employment and training must be substantially uniform throughout the length of the contract, and in each trade, and the Contractor shall make a good faith effort to employ minorities and women evenly on each of its projects. The transfer of minority or female employees or trainees from contractor to contractor or from project to project for the sole purpose of meeting the contractor's goals shall be a violation of contract, the Executive Order and the regulations in 41 CFR, Part 60.4. Compliance with the goals will be measured against the total work hours performed.
- E. The Contractor shall provide written notification to the Director of the Office of Federal Contract Compliance Programs within ten (10) working days of award of any construction subcontract in excess of \$10,000 at any tier for construction work under the contract resulting from this solicitation. The notification shall list the name, address and telephone number of the Subcontractor; employer identification number, estimated dollar amount of the

subcontract, estimated starting and completion dates of the subcontract, and the geographical area in which the contract is to be performed.

- F. As used in this Notice, and in the contract resulting from this solicitation, the “covered area” is Chicago PMSA.

V. FEDERAL EQUAL EMPLOYMENT OPPORTUNITY CONSTRUCTION CONTRACT SPECIFICATIONS (*Executive Order 11246*)

A. ***As Used In These Specifications:***

1. “*Covered Area*” means the geographical area described in the solicitation from which this contract is resulted.
2. “*Director*” means Director, Office of Federal Contract Compliance Programs, United States Department of Labor or any person to whom the Director delegates authority.
3. “*Employer identification numbers*” means the Federal Social Security number used on the Employer’s Quarterly Federal Tax Return, U. S. Treasury Department Form 941.

B. ***“Minority” Includes:***

1. *Black* - All persons having origins in any of the Black African racial groups not of Hispanic origin.
2. *Hispanic* – All persons of Mexican, Puerto Rican, Cuban, Central and South American or other Spanish Culture or origin, regardless of race.
3. *Asian and Pacific Islander* – All persons having origins in any of the original peoples of the Far East, Southeast Asia, the Indian Subcontinent, or the Pacific Islands.
4. *American Indian or Alaskan Native* – All persons having origins in any of the original peoples of North America and maintaining identifiable tribal affiliations through membership and participation or community identification.

C. ***Subcontracts***

1. Whenever the Contractor or any Subcontractor at any tier, subcontracts a portion of the work involving any construction trade, it shall physically include in each subcontract in excess of \$10,000 the provisions of these specifications and the Notice which contains the applicable goals for minority and female participation and which is set forth in the solicitations from which this contract resulted.
2. If the Contractor is participating (pursuant to the 41 CFR, Part 60 4.5) in a Hometown Plan approved by the U. S. Department of Labor in the covered area either individually or through an association, its affirmative action obligations on all work in the Plan area (including goals and timetables) shall be in accordance with the Plan for those trades which have unions participating in the Plan. Contractors must be able to demonstrate their participation in and compliance with the provisions of any such Hometown Plan. Each Contractor or Subcontractor participating in an approved Plan is individually required to comply with its obligations under the EEO clause, and to make a good faith effort to achieve each goal under the Plan in each trade in which it has employees. The overall good faith performance by other contractors or subcontractors toward a goal in an

approved Plan does not excuse any covered Contractor or Subcontractor's failure to take good faith efforts to achieve the Plan goals and timetables.

3. The Contractor shall implement the specific affirmative action standards provided in paragraphs 7 (I) through (XVI) of these specifications. The goals set forth in the solicitation from which this contract resulted are expressed as percentages of the total hours of employment and training of minority and female utilization the Contractor should reasonably be able to achieve in each construction trade in which it has employees in the covered area. The Contractor is expected to make substantially uniform progress toward its goals in each craft during the period specified.
4. Neither the provisions of any collective bargaining agreement, nor the failure by a union with whom the Contractor has a collective bargaining agreement, to refer either minorities or women shall excuse the Contractor's obligations under these specifications, Executive Order 11246 or the regulations promulgated pursuant thereto.
5. In order for the nonworking training hours of apprentices and trainees to be counted in meeting the goals, such apprentices and trainees must be employed by the Contractor during the training period, and the Contractor must have made a commitment to employ the apprentices and trainees at the completion of their training, subject to the availability of employment opportunities. Trainees must be trained pursuant to training programs approved by the U. S. Department of Labor.
6. The Contractor shall take specific affirmative actions to ensure equal employment opportunity. The evaluation of the Contractor's compliance with these specifications shall be based upon its effort to achieve maximum results from its acts. The Contractor shall document these efforts fully and shall implement affirmative action steps at least as extensive as the following.

D. *Equal Employment Opportunity Documentation*

1. Ensure and maintain a working environment free of harassment, intimidation and coercion at all sites, and in tall facilities at which the Contractor's employees are assigned to work. The Contractor, where possible, will assign two or more women to each construction project. The Contractor shall specifically ensure that all foremen, superintendents and other on-site supervisory personnel are aware of any carrying out of the Contractor's obligation to maintain such a working environment, with specific attention to minority or female individuals working at such sites or in such facilities.
2. Establish and maintain a current list of minority and female recruitment sources, provide written notification to minority and female recruitment sources and to community organizations when the Contractor or its unions have employment opportunities available, and maintain a record of organization's responses.
3. Maintain a current file of the names, addresses and telephone numbers of each minority and female off-the-street applicant and minority or female referral from a union, a recruitment source or community organization and of what action was taken with respect to each such individual. If such individuals were sent to the union hiring hall for referral and were not referred back to the Contractor by the union or, if referred, not employed by the Contractor, this shall be documented in the file with the reason, therefore along with whatever additional actions the Contractor may have taken.

4. Provide immediate written notification to the Director when the union or unions with which the Contractor has a collective bargaining agreement has not referred to the Contractor a minority person or woman sent by the Contractor or when the Contractor has other information that the union referral process has impeded the Contractor's efforts to meet its obligations.
5. Develop on-the-job training opportunities and/or participate in training programs for the area which expressly include minorities and women and apprenticeship and trainee programs relevant to the Contractor's employment needs, especially those programs funded or approved by the Department of Labor. The Contractor shall provide notice of these programs to the sources compiled under D (2) above.
6. Disseminate the Contractor's EEO policy by providing notice of the policy to unions and training programs and requesting their cooperation in assisting the Contractor in meeting its EEO obligations; by including it in any policy manual and collective bargaining agreement by publicizing it in the company newspaper, annual report, etc; by specific review of the policy with all management personnel and with all minority and female employees at least once a year; and by posting the company EEO policy on bulletin boards accessible to all employees at each location where construction work is performed.
7. Review, at least annually, the company's EEO policy and affirmative action obligations under these specifications with all employees having any responsibility for hiring, assignment, layoff, termination or other employment decisions including specific review of these items with onsite supervisory personnel such as superintendents, general foremen, etc., prior to the initiation of construction work at any job site. A written record shall be made and maintained identifying the time and place of these meetings, persons attending, subject matter discussed, and the disposition of the subject matter.
8. Disseminate the Contractor's EEO policy externally by including it in any advertising in the news media, specifically including minority and female news media, and providing written notification to and discussing the Contractor's EEO policy with other contractors and subcontractors with whom the Contractor does or anticipates doing business.
9. Direct its recruitment efforts, both oral and written, to minority, female and community organizations, to schools with minority and female students, and to minority and female recruitment and training organizations serving the Contractor's recruitment area and employment needs. Not later than one month prior to the date for the acceptance of applications for apprenticeship or other training by any recruitment source, the Contractor shall send written notification to organizations, such as the above, describing the openings, screening procedures and tests to be used in the selection process.
10. Encourage present minority and female employees to recruit other minority persons and women, and where reasonable, provide after school, summer and vacation employment to minority and female youth, both on the site and in other areas of Contractor's work force.
11. Validate all tests and other selection requirements where there is an obligation to do so under 41 CFR, Part 60, 3.
12. Conduct, at least annually, an inventory and evaluation of at least of all minority and female personnel for promotional opportunities and encourage these employees to seek or to prepare for (through appropriate training, etc.) such opportunities.

13. Ensure that seniority practices, job classifications, work assignments and other personnel practices, do not have a discriminatory effect by continually monitoring all personnel and employment related activities to ensure that the EEO policy and the Contractor's obligations under these specifications are being carried out.
14. Ensure that all facilities and company activities are non-segregated except that separate or single user toilet and necessary changing facilities shall be provided to ensure privacy between the sexes.
15. Document and maintain a record of all solicitations of offers for subcontracts from minority and female construction contractors and suppliers, including circulation of solicitations to minority and female contractor associations and other business associations.
16. Conduct a review, at least annually, of all supervisors' adherence to and performance under the Contractor's EEO policies and affirmative action obligations.
17. Covered construction contractors performing contracts in geographical areas where they do not have a Federal or federally assisted construction contract shall apply the minority and female goals established for the geographical area where the contract is being performed. Goals are published periodically in the Federal Register in notice form and such notices may be obtained from any Office of Federal Contract Compliance Programs office from Federal Procurement contracting officers.

E. Voluntary Associations

1. Contractors are encouraged to participate in voluntary associations, which assist in fulfilling one or more of their affirmative action obligations, D-1 through D-17. The efforts of a contractor association, joint contractor-union, contractor-community or other similar group of which the Contractor is a member and participant, may be asserted as fulfilling any one or more of its obligations under D-1 through D17 of these specifications provided that the Contractor actively participates in the group, makes every effort to assure that the group has a positive impact on employment of minorities and women in the industry, ensures that the concrete benefits of the program are reflected in the Contractor's minority and female workforce participation, makes a good faith effort to meet its individual goals and timetables, and can provide access to documentation which demonstrates the effectiveness of actions taken on behalf of the Contractor. The obligation shall not be a defense for the Contractor's non-compliance.
2. A single goal for minorities and a separate single goal for women have been established. The Contractor, however, is required to provide equal employment opportunity and to take affirmative action for all minority groups, both male and female, and all women, both minority and non-minority. Consequently, the Contractor may be in violation of the Executive Order if a particular group is employed in a substantially disparate manner (for example, even though the Contractor has achieved its goals for women generally, the Contractor may be in violation of the Executive order if a specific minority group of women is under utilized).
3. The Contractor shall not use the goals and timetables or affirmative action standards to discriminate against any person because of race, color, religion, sex or national origin.

4. The Contractor shall not enter into any subcontract with any person or firm debarred from Government contracts pursuant to Executive Order 11246, as amended.
 5. The Contractor shall carry out such sanctions and penalties for violation of these specifications and of the Equal Opportunity Clause, including suspension, termination and cancellation of existing subcontracts as may be imposed or ordered pursuant to the Executive Order 11246, as amended, and its implementing regulations, by the Office of Federal Contract Compliance Programs. Any contractor who fails to carry out such sanctions and penalties shall be in violation of these specifications and Executive Order 11246, as amended.
 6. The Contractor, in fulfilling its obligations under these specifications, shall implement specific affirmative action steps, at least as extensive as those standards prescribed in paragraph 7 of these specifications, so as to achieve maximum results from its efforts to ensure equal employment opportunity. If the Contractor fails to comply with the requirements of the Executive Order, the implementing regulations or these specifications, the Director shall proceed in accordance with 41 CFR, Part 60,4.8.
 7. The Contractor shall designate a responsible official to monitor all employment related activity to ensure that the company EEO policy is being carried out, to submit reports relating to the provisions hereof as may be required by the Government and to keep records. Records shall at least include for each employee the name, address, telephone numbers, construction trade, union affiliation (if any), employee identification number when assigned, social security number, race, sex, status (e.g. mechanic, apprentice trainee, helper or laborer), dates of changes in status, hours worked per week in the indicated rate of pay and locations at which the work was performed. Records shall be maintained in an easily understandable and retrievable form; however, to the degree that existing records satisfy this requirement, contractors shall not be required to maintain separate records.
 8. Nothing herein provided shall be construed as a limitation upon the application of other laws, which establish different standards of compliance or upon the application of requirements for the hiring of local or other area residents (e.g. those under the Public Works Employment Act of 1977 and the Community Development Block Grant Program).
- F. ***Civil Rights Act of 1964***
Under the Title VI of the Civil Rights Act of 1964, no person shall, on the grounds of race, color or national origin, be excluded from participation in, be denied the benefits of or be subjected to discrimination under any program or activity receiving Federal financial assistance.
- G. ***Section 109 Of The Housing And Community Development Act Of 1974***
No person in the United States shall on the ground of race, color, national origin or sex be excluded from participation in, be denied the benefits of or be subjected to discrimination under any program or activity funded in whole or in part with funds made available under this title.
- H. ***“Section 3” Compliance In The Provisions Of Training, Employment And Business Opportunities***
1. The work to be performed under this contract is subject to the requirements of Section 3 of the Housing and Urban Development Act of 1968, as amended, 12 USC 1701u (Section 3).

2. The purpose of Section 3 is to ensure that employment and other economic opportunities generated by HUD assistance or HUD-assisted projects covered by Section 3, shall, to be the greatest extent feasible, be directed to low and very low-income persons, particularly persons who are recipients of HUD assistance for housing.
3. The parties to this contract agree to comply with HUD's regulations in 24 CFR, Part 135, which implement Section 3. As evidenced by their execution of this contract, the parties to this contract certify that they are under no contractual or other impediment that would prevent them from complying with Part 135 requirements.
4. The Contractor agrees to send to each labor organization or representative of workers with which the Contractor has a collective bargaining agreement or other understanding, if any, a notice advising the labor organization or workers' representative of the Contractor's commitments under this Section 3 clause, and will post copies of the notice in conspicuous places at the work site where both employees and applicants for training and employment positions can see the notice. The notice shall describe the Section 3 preference, shall set forth minimum number and job titles subject to hire, availability of apprenticeship and training positions and the qualifications for each, and the name and location of the person(s) taking applications for each of the positions, and the anticipated date the work shall begin.
5. The Contractor agrees to include this Section 3 clause in every subcontract subject to compliance with regulations in 24 CFR, Part 135, and agrees to take appropriate action as provided in the applicable provision of the subcontract in this Section 3 clause, upon a finding that the Subcontractor is in violation of the regulations in 24 CFR, Part 135. The Contractor will not subcontract with any Subcontractor where the Contractor has notice or knowledge that the Subcontractor has been found in violation of regulations under 24 CFR, Part 135.
6. The Contractor will certify that any vacant employment positions, including training positions, that are filled (1) after the contractor is selected but before the contract is executed, and (2) with persons other than those to whom the regulations of 24 CFR, Part 135 require employment opportunities to be directed, were not filled to circumvent the Contractor's obligations under 24 CFR, Part 135.
7. Noncompliance with HUD's regulations in 24 CFR, Part 135 may result in sanctions, termination of this contract for default and debarment or suspension from future HUD-assisted contracts.

VI. CONTRACT WORK HOURS AND SAFETY STANDARDS

As a condition of any grant, contract, loan, insurance or guarantee involving federally assisted construction, DuPage County requires the following language to be included in full in any contract subject to the Contract Work Hours and Safety Standards ACT. As used in the section, the terms "*laborers*" and "*mechanics*" include watchmen and guards.

"The subgrantee, in accordance with Title 29, CFR, Part 5, hereby agrees that it will ensure the inclusion in all construction contract documents and bid specifications".

A. ***Overtime Requirements***

No Contractor or Subcontractor contracting for any part of the contract work which may require or involve the employment of laborers or mechanics shall require or permit any laborer or mechanic in any workweek in which he is employed on such work to work in excess of forty hours in such workweek unless such laborer or mechanic receives compensation at a rate not less than one and one-half times his basic rate of pay for all hours worked in excess of forty hours in such workweek.

B. ***Violation and Liability for Unpaid Wages and Liquidated Damages***

In the event of any violation of the clause set forth in Subsection A, the Contractor and any Subcontractor responsible therefore shall be liable to any affected employee for his unpaid wages. In addition, such Contractor and Subcontractor shall be to the United States for liquidated damages. Such liquidated damages shall be computed with respect to each individual laborer or mechanic employed in violation of the clause set forth in Subsection A, in the sum of \$10 for each calendar day on which such employee was required or permitted to work in excess of the standard workweek of forty hours without payment of the overtime wages required by the clause set forth in Subsection A.

C. ***Withholding for Unpaid Wages and Liquidated Damages***

The DuPage County Community Development Specialist may withhold or cause to be withheld from any monies payable on account of work performed by the Contractor or Subcontractor such sums as may administratively be determined to be necessary to satisfy an liabilities of such Contractor or Subcontractor for unpaid wages and liquidated damages as provided in the clause set forth in Subsection B.

D. ***Subcontract***

The Contractor shall insert in any subcontracts the clauses set for in subsections A, B and C of this section and also a clause requiring the subcontractors to include these clauses in any lower tier subcontracts which they may enter into, together with a clause requiring this insertion in any further subcontracts they may in turn be made.

E. ***Contractor's Responsibility***

The Contractor shall be responsible for compliance by any Subcontractor or lower tier subcontractor with the clauses set forth in Subparagraph A through D.

VII. SAFETY

In the performance of this contract, the Contractor shall comply with all applicable Federal, State and local laws governing safety, health and sanitation. The Contractor shall provide all safeguards, safety devices and protective equipment, and take any other needed actions, on his own responsibility or the DuPage County Community Development Specialist may determine reasonably necessary to protect the life and health of employees on the job and the safety of the public and to protect property in connection with the performance of the work covered by the contract.

VIII. FALSE STATEMENTS CONCERNING PROJECTS

In order to assure high quality and durable construction in conformity with approved plans and specifications and a high degree of reliability on statements and representations made by engineers, contractors, suppliers and workers on projects utilizing Federal funds, it is essential

that all persons concerned with the project perform their functions as carefully, thoroughly and honestly as possible. Willful falsification, distortion or misrepresentation with respect to any facts related to the project is a violation of Federal law.

IX. IMPLEMENTATION OF CLEAN AIR ACT

Contract requirements

- A. The Contractor stipulates that any facility to be utilized in the performance of this contract, unless such contract is exempt under the Clean Air Act, as amended (PL 91-604, 42 U.S.C 1857, as amended by PL 95-95 and PL 95-960, 42 USC 4362, 7401 et Seq.), Executive Order 11738, and regulations in implementation thereof (40 CFR, Part 15) is not listed, on the date of contract award, on the U.S. Environmental Protection Agency (EPA) List of Violating Facilities Pursuant to Title 40 CFR, Part 15.
- B. The Contractor agrees to comply with all the requirements of Section 114 of the Clean Air Act, as amended, relating to inspection, monitoring, entry reports and information, as well as, all other requirements specified in Section 114 and all regulations and guidelines listed there under.
- C. The Contractor shall promptly notify the Community Development Specialist of the receipt of any communication from the Director, Office of Federal Activities, or the EPA, indicating that a facility to be utilized for the contract is under consideration to be listed on the EPA Listing of Violating Facilities.
- D. The Contractor agrees to include or cause to be included the requirements of subparagraphs A through D of this section in every nonexempt subcontract and further agrees to take such action as the Government may direct as a means of enforcing such requirements.

X. LABOR STANDARDS

Except as otherwise provided, DuPage County requires the inclusion of the HUD Federal Labor Standards Provisions Form 4010 as a condition of any grant, contract, loan, insurance or guarantee involving federally assisted construction.

EXECUTIVE ORDER 11246 EQUAL EMPLOYMENT OPPORTUNITY

SOURCE: The provisions of Executive Order 11246 of Sept. 24, 1965, appear at 30 FR 12319, 12935, 3 CFR, 1964-1965 Comp., p.339, unless otherwise noted.

Under and by virtue of the authority vested in me as President of the United States by the Constitution and statutes of the United States, it is ordered as follows:

Part I - Nondiscrimination in Government Employment

[Part I superseded by EO 11478 of Aug. 8, 1969, 34 FR 12985, 3 CFR, 1966-1970 Comp., p. 803]

Part II - Nondiscrimination in Employment by Government Contractors and Subcontractors

Subpart A - Duties of the Secretary of Labor

SEC. 201. The Secretary of Labor shall be responsible for the administration and enforcement of Parts II and III of this Order. The Secretary shall adopt such rules and regulations and issue such orders as are deemed necessary and appropriate to achieve the purposes of Parts II and III of this Order.

[Sec. 201 amended by EO 12086 of Oct. 5, 1978, 43 FR 46501, 3 CFR, 1978 Comp., p. 230]

Subpart B - Contractors' Agreements

SEC. 202. Except in contracts exempted in accordance with Section 204 of this Order, all Government contracting agencies shall include in every Government contract hereafter entered into the following provisions:

During the performance of this contract, the contractor agrees as follows:

(1) The contractor will not discriminate against any employee or applicant for employment because of race, color, religion, sex, or national origin. The contractor will take affirmative action to ensure that applicants are employed, and that employees are treated during employment, without regard to their race, color, religion, sex or national origin. Such action shall include, but not be limited to the following: employment, upgrading, demotion, or transfer; recruitment or recruitment advertising; layoff or termination; rates of pay or other forms of compensation; and selection for training, including apprenticeship. The contractor agrees to post in conspicuous places, available to employees and applicants for employment, notices to be provided by the contracting officer setting forth the provisions of this nondiscrimination clause.

(2) The contractor will, in all solicitations or advancements for employees placed by or on behalf of the contractor, state that all qualified applicants will receive consideration for employment without regard to race, color, religion, sex or national origin.

(3) The contractor will send to each labor union or representative of workers with which he has a collective bargaining agreement or other contract or understanding, a notice, to be provided by the agency contracting officer, advising the labor union or workers' representative of the contractor's commitments under Section 202 of Executive Order No. 11246 of September 24,

1965, and shall post copies of the notice in conspicuous places available to employees and applicants for employment.

(4) The contractor will comply with all provisions of Executive Order No. 11246 of Sept. 24, 1965, and of the rules, regulations, and relevant orders of the Secretary of Labor.

(5) The contractor will furnish all information and reports required by Executive Order No. 11246 of September 24, 1965, and by the rules, regulations, and orders of the Secretary of Labor, or pursuant thereto, and will permit access to his books, records, and accounts by the contracting agency and the Secretary of Labor for purposes of investigation to ascertain compliance with such rules, regulations, and orders.

(6) In the event of the contractor's noncompliance with the nondiscrimination clauses of this contract or with any of such rules, regulations, or orders, this contract may be cancelled, terminated, or suspended in whole or in part and the contractor may be declared ineligible for further Government contracts in accordance with procedures authorized in Executive Order No. 11246 of Sept. 24, 1965, and such other sanctions may be imposed and remedies invoked as provided in Executive Order No. 11246 of September 24, 1965, or by rule, regulation, or order of the Secretary of Labor, or as otherwise provided by law.

(7) The contractor will include the provisions of paragraphs (1) through (7) in every subcontract or purchase order unless exempted by rules, regulations, or orders of the Secretary of Labor issued pursuant to Section 204 of Executive Order No. 11246 of September 24, 1965, so that such provisions will be binding upon each subcontractor or vendor. The contractor will take such action with respect to any subcontract or purchase order as may be directed by the Secretary of Labor as a means of enforcing such provisions including sanctions for noncompliance: Provided, however, that in the event the contractor becomes involved in, or is threatened with, litigation with a subcontractor or vendor as a result of such direction, the contractor may request the United States to enter into such litigation to protect the interests of the United States." [Sec. 202 amended by EO 11375 of Oct. 13, 1967, 32 FR 14303, 3 CFR, 1966-1970 Comp., p. 684, EO 12086 of Oct. 5, 1978, 43 FR 46501, 3 CFR, 1978 Comp., p. 230]

SEC. 203. Each contractor having a contract containing the provisions prescribed in Section 202 shall file, and shall cause each of his subcontractors to file, Compliance Reports with the contracting agency or the Secretary of Labor as may be directed. Compliance Reports shall be filed within such times and shall contain such information as to the practices, policies, programs, and employment policies, programs, and employment statistics of the contractor and each subcontractor, and shall be in such form, as the Secretary of Labor may prescribe.

(b) Bidders or prospective contractors or subcontractors may be required to state whether they have participated in any previous contract subject to the provisions of this Order, or any preceding similar Executive order, and in that event to submit, on behalf of themselves and their proposed subcontractors, Compliance Reports prior to or as an initial part of their bid or negotiation of a contract.

(c) Whenever the contractor or subcontractor has a collective bargaining agreement or other contract or understanding with a labor union or an agency referring workers or providing or supervising apprenticeship or training for such workers, the Compliance Report shall include such information as to such labor union's or agency's practices and policies affecting compliance as the Secretary of Labor may prescribe: Provided, That to the extent such information is within the exclusive possession of a labor union or an agency referring workers or providing or supervising apprenticeship or training and such labor union or agency shall refuse to furnish such information to the contractor, the contractor shall so certify to the Secretary of Labor as part of its Compliance Report and shall set forth what efforts he has made to obtain such information.

(d) The Secretary of Labor may direct that any bidder or prospective contractor or subcontractor shall submit, as part of his Compliance Report, a statement in writing, signed by an authorized officer or agent on behalf of any labor union or any agency referring workers or providing or

supervising apprenticeship or other training, with which the bidder or prospective contractor deals, with supporting information, to the effect that the signer's practices and policies do not discriminate on the grounds of race, color, religion, sex or national origin, and that the signer either will affirmatively cooperate in the implementation of the policy and provisions of this Order or that it consents and agrees that recruitment, employment, and the terms and conditions of employment under the proposed contract shall be in accordance with the purposes and provisions of the order. In the event that the union, or the agency shall refuse to execute such a statement, the Compliance Report shall so certify and set forth what efforts have been made to secure such a statement and such additional factual material as the Secretary of Labor may require.

[Sec. 203 amended by EO 11375 of Oct. 13, 1967, 32 FR 14303, 3 CFR, 1966-1970 Comp., p. 684; EO 12086 of Oct. 5, 1978, 43 FR 46501, 3 CFR, 1978 Comp., p. 230]

SEC. 204 (a) The Secretary of Labor may, when the Secretary deems that special circumstances in the national interest so require, exempt a contracting agency from the requirement of including any or all of the provisions of Section 202 of this **Order** in any specific contract, subcontract, or purchase **order**.

(b) The Secretary of Labor may, by rule or regulation, exempt certain classes of contracts, subcontracts, or purchase orders (1) whenever work is to be or has been performed outside the United States and no recruitment of workers within the limits of the United States is involved; (2) for standard commercial supplies or raw materials; (3) involving less than specified amounts of money or specified numbers of workers; or (4) to the extent that they involve subcontracts below a specified tier.

(c) Section 202 of this **Order** shall not apply to a Government contractor or subcontractor that is a religious corporation, association, educational institution, or society, with respect to the employment of individuals of a particular religion to perform work connected with the carrying on by such corporation, association, educational institution, or society of its activities. Such contractors and subcontractors are not exempted or excused from complying with the other requirements contained in this **Order**.

(d) The Secretary of Labor may also provide, by rule, regulation, or order, for the exemption of facilities of a contractor that are in all respects separate and distinct from activities of the contractor related to the performance of the contract: provided, that such an exemption will not interfere with or impede the effectuation of the purposes of this **Order**: and provided further, that in the absence of such an exemption all facilities shall be covered by the provisions of this **Order**."

[Sec. 204 amended by EO 13279 of Dec. 16, 2002, 67 FR 77141, 3 CFR, 2002 Comp., p. 77141 - 77144]

Subpart C - Powers and Duties of the Secretary of Labor and the Contracting Agencies

SEC. 205. The Secretary of Labor shall be responsible for securing compliance by all Government contractors and subcontractors with this Order and any implementing rules or regulations. All contracting agencies shall comply with the terms of this Order and any implementing rules, regulations, or orders of the Secretary of Labor. Contracting agencies shall cooperate with the Secretary of Labor and shall furnish such information and assistance as the Secretary may require.

[Sec. 205 amended by EO 12086 of Oct. 5, 1978, 43 FR 46501, 3 CFR, 1978 Comp., p. 230]

SEC. 206. The Secretary of Labor may investigate the employment practices of any Government contractor or subcontractor to determine whether or not the contractual provisions specified in Section 202 of this Order have been violated. Such investigation shall be conducted in accordance with the procedures established by the Secretary of Labor.

(b) The Secretary of Labor may receive and investigate complaints by employees or prospective employees of a Government contractor or subcontractor which allege discrimination contrary to the contractual provisions specified in Section 202 of this Order.

[Sec. 206 amended by EO 12086 of Oct. 5, 1978, 43 FR 46501, 3 CFR, 1978 Comp., p. 230]

SEC. 207. The Secretary of Labor shall use his/her best efforts, directly and through interested Federal, State, and local agencies, contractors, and all other available instrumentalities to cause any labor union engaged in work under Government contracts or any agency referring workers or providing or supervising apprenticeship or training for or in the course of such work to cooperate in the implementation of the purposes of this Order. The Secretary of Labor shall, in appropriate cases, notify the Equal Employment Opportunity Commission, the Department of Justice, or other appropriate Federal agencies whenever it has reason to believe that the practices of any such labor organization or agency violate Title VI or Title VII of the Civil Rights Act of 1964 or other provision of Federal law.

[Sec. 207 amended by EO 12086 of Oct. 5, 1978, 43 FR 46501, 3 CFR, 1978 Comp., p. 230]

SEC. 208. The Secretary of Labor, or any agency, officer, or employee in the executive branch of the Government designated by rule, regulation, or order of the Secretary, may hold such hearings, public or private, as the Secretary may deem advisable for compliance, enforcement, or educational purposes.

(b) The Secretary of Labor may hold, or cause to be held, hearings in accordance with Subsection of this Section prior to imposing, ordering, or recommending the imposition of penalties and sanctions under this Order. No order for debarment of any contractor from further Government contracts under Section 209(6) shall be made without affording the contractor an opportunity for a hearing.

Subpart D - Sanctions and Penalties

SEC. 209. In accordance with such rules, regulations, or orders as the Secretary of Labor may issue or adopt, the Secretary may:

(1) Publish, or cause to be published, the names of contractors or unions which it has concluded have complied or have failed to comply with the provisions of this Order or of the rules, regulations, and orders of the Secretary of Labor.

(2) Recommend to the Department of Justice that, in cases in which there is substantial or material violation or the threat of substantial or material violation of the contractual provisions

set forth in Section 202 of this Order, appropriate proceedings be brought to enforce those provisions, including the enjoining, within the limitations of applicable law, of organizations, individuals, or groups who prevent directly or indirectly, or seek to prevent directly or indirectly, compliance with the provisions of this Order.

(3) Recommend to the Equal Employment Opportunity Commission or the Department of Justice that appropriate proceedings be instituted under Title VII of the Civil Rights Act of 1964.

(4) Recommend to the Department of Justice that criminal proceedings be brought for the furnishing of false information to any contracting agency or to the Secretary of Labor as the case may be.

(5) After consulting with the contracting agency, direct the contracting agency to cancel, terminate, suspend, or cause to be cancelled, terminated, or suspended, any contract, or any portion or portions thereof, for failure of the contractor or subcontractor to comply with equal employment opportunity provisions of the contract. Contracts may be cancelled, terminated, or suspended absolutely or continuance of contracts may be conditioned upon a program for future compliance approved by the Secretary of Labor.

(6) Provide that any contracting agency shall refrain from entering into further contracts, or extensions or other modifications of existing contracts, with any noncomplying contractor, until such contractor has satisfied the Secretary of Labor that such contractor has established and will carry out personnel and employment policies in compliance with the provisions of this Order.

(b) Pursuant to rules and regulations prescribed by the Secretary of Labor, the Secretary shall make reasonable efforts, within a reasonable time limitation, to secure compliance with the contract provisions of this Order by methods of conference, conciliation, mediation, and persuasion before proceedings shall be instituted under subsection (a)(2) of this Section, or before a contract shall be cancelled or terminated in whole or in part under subsection (a)(5) of this Section.

[Sec. 209 amended by EO 12086 of Oct. 5, 1978, 43 FR 46501, 3 CFR, 1978 Comp., p. 230]

SEC. 210. Whenever the Secretary of Labor makes a determination under Section 209, the Secretary shall promptly notify the appropriate agency. The agency shall take the action directed by the Secretary and shall report the results of the action it has taken to the Secretary of Labor within such time as the Secretary shall specify. If the contracting agency fails to take the action directed within thirty days, the Secretary may take the action directly.

[Sec. 210 amended by EO 12086 of Oct. 5, 1978, 43 FR 46501, 3 CFR, 1978 Comp., p. 230]

SEC. 211. If the Secretary shall so direct, contracting agencies shall not enter into contracts with any bidder or prospective contractor unless the bidder or prospective contractor has satisfactorily complied with the provisions of this Order or submits a program for compliance acceptable to the Secretary of Labor.

[Sec. 211 amended by EO 12086 of Oct. 5, 1978, 43 FR 46501, 3 CFR, 1978 Comp., p. 230]

SEC. 212. When a contract has been cancelled or terminated under Section 209(a)(5) or a contractor has been debarred from further Government contracts under Section 209(a)(6) of this Order, because of noncompliance with the contract provisions specified in Section 202 of this Order, the Secretary of Labor shall promptly notify the Comptroller General of the United States.

[Sec. 212 amended by EO 12086 of Oct. 5, 1978, 43 FR 46501, 3 CFR, 1978 Comp., p. 230]

Subpart E - Certificates of Merit

SEC. 213. The Secretary of Labor may provide for issuance of a United States Government Certificate of Merit to employers or labor unions, or other agencies which are or may hereafter be engaged in work under Government contracts, if the Secretary is satisfied that the personnel and employment practices of the employer, or that the personnel, training, apprenticeship,

membership, grievance and representation, upgrading, and other practices and policies of the labor union or other agency conform to the purposes and provisions of this Order.

SEC. 214. Any Certificate of Merit may at any time be suspended or revoked by the Secretary of Labor if the holder thereof, in the judgment of the Secretary, has failed to comply with the provisions of this Order.

SEC. 215. The Secretary of Labor may provide for the exemption of any employer, labor union, or other agency from any reporting requirements imposed under or pursuant to this Order if such employer, labor union, or other agency has been awarded a Certificate of Merit which has not been suspended or revoked.

Part III - Nondiscrimination Provisions in Federally Assisted Construction Contracts

SEC. 301. Each executive department and agency, which administers a program involving Federal financial assistance shall require as a condition for the approval of any grant, contract, loan, insurance, or guarantee thereunder, which may involve a construction contract, that the applicant for Federal assistance undertake and agree to incorporate, or cause to be incorporated, into all construction contracts paid for in whole or in part with funds obtained from the Federal Government or borrowed on the credit of the Federal Government pursuant to such grant, contract, loan, insurance, or guarantee, or undertaken pursuant to any Federal program involving such grant, contract, loan, insurance, or guarantee, the provisions prescribed for Government contracts by Section 202 of this Order or such modification thereof, preserving in substance the contractor's obligations thereunder, as may be approved by the Secretary of Labor, together with such additional provisions as the Secretary deems appropriate to establish and protect the interest of the United States in the enforcement of those obligations. Each such applicant shall also undertake and agree (1) to assist and cooperate actively with the Secretary of Labor in obtaining the compliance of contractors and subcontractors with those contract provisions and with the rules, regulations and relevant orders of the Secretary, (2) to obtain and to furnish to the Secretary of Labor such information as the Secretary may require for the supervision of such compliance, (3) to carry out sanctions and penalties for violation of such obligations imposed upon contractors and subcontractors by the Secretary of Labor pursuant to Part II, Subpart D, of this Order, and (4) to refrain from entering into any contract subject to this Order, or extension or other modification of such a contract with a contractor debarred from Government contracts under Part II, Subpart D, of this Order.

[Sec. 301 amended by EO 12086 of Oct. 5, 1978, 43 FR 46501, 3 CFR, 1978 Comp., p. 230]

SEC. 302. "Construction contract" as used in this Order means any contract for the construction, rehabilitation, alteration, conversion, extension, or repair of buildings, highways, or other improvements to real property.

(b) The provisions of Part II of this Order shall apply to such construction contracts, and for purposes of such application the administering department or agency shall be considered the contracting agency referred to therein.

(c) The term "applicant" as used in this Order means an applicant for Federal assistance or, as determined by agency regulation, other program participant, with respect to whom an application for any grant, contract, loan, insurance, or guarantee is not finally acted upon prior to the effective date of this Part, and it includes such an applicant after he/she becomes a recipient of such Federal assistance.

SEC. 303. The Secretary of Labor shall be responsible for obtaining the compliance of such applicants with their undertakings under this Order. Each administering department and agency is directed to cooperate with the Secretary of Labor and to furnish the Secretary such

information and assistance as the Secretary may require in the performance of the Secretary's functions under this Order.

(b) In the event an applicant fails and refuses to comply with the applicant's undertakings pursuant to this Order, the Secretary of Labor may, after consulting with the administering department or agency, take any or all of the following actions: (1) direct any administering department or agency to cancel, terminate, or suspend in whole or in part the agreement, contract or other arrangement with such applicant with respect to which the failure or refusal occurred; (2) direct any administering department or agency to refrain from extending any further assistance to the applicant under the program with respect to which the failure or refusal occurred until satisfactory assurance of future compliance has been received by the Secretary of Labor from such applicant; and (3) refer the case to the Department of Justice or the Equal Employment Opportunity Commission for appropriate law enforcement or other proceedings.

(c) In no case shall action be taken with respect to an applicant pursuant to clause (1) or (2) of subsection (b) without notice and opportunity for hearing.

[Sec. 303 amended by EO 12086 of Oct. 5, 1978, 43 FR 46501, 3 CFR, 1978 Comp., p. 230]

SEC. 304. Any executive department or agency which imposes by rule, regulation, or order requirements of nondiscrimination in employment, other than requirements imposed pursuant to this Order, may delegate to the Secretary of Labor by agreement such responsibilities with respect to compliance standards, reports, and procedures as would tend to bring the administration of such requirements into conformity with the administration of requirements imposed under this Order: Provided, That actions to effect compliance by recipients of Federal financial assistance with requirements imposed pursuant to Title VI of the Civil Rights Act of 1964 shall be taken in conformity with the procedures and limitations prescribed in Section 602 thereof and the regulations of the administering department or agency issued thereunder.

Part IV - Miscellaneous

SEC. 401. The Secretary of Labor may delegate to any officer, agency, or employee in the Executive branch of the Government, any function or duty of the Secretary under Parts II and III of this Order.

[Sec. 401 amended by EO 12086 of Oct. 5, 1978, 43 FR 46501, 3 CFR, 1978 Comp., p. 230]

SEC. 402. The Secretary of Labor shall provide administrative support for the execution of the program known as the "Plans for Progress."

SEC. 403. Executive Orders Nos. 10590 (January 19, 1955), 10722 (August 5, 1957), 10925 (March 6, 1961), 11114 (June 22, 1963), and 11162 (July 28, 1964), are hereby superseded and the President's Committee on Equal Employment Opportunity established by Executive Order No.

10925 is hereby abolished. All records and property in the custody of the Committee shall be transferred to the Office of Personnel Management and the Secretary of Labor, as appropriate.

(b) Nothing in this Order shall be deemed to relieve any person of any obligation assumed or imposed under or pursuant to any Executive Order superseded by this Order. All rules, regulations, orders, instructions, designations, and other directives issued by the President's Committee on Equal Employment Opportunity and those issued by the heads of various departments or agencies under or pursuant to any of the Executive orders superseded by this Order, shall, to the extent that they are not inconsistent with this Order, remain in full force and effect unless and until revoked or superseded by appropriate authority. References in such

directives to provisions of the superseded orders shall be deemed to be references to the comparable provisions of this Order.

[Sec. 403 amended by EO 12107 of Dec. 28, 1978, 44 FR 1055, 3 CFR, 1978 Comp., p, 264]

SEC. 404. The General Services Administration shall take appropriate action to revise the standard Government contract forms to accord with the provisions of this Order and of the rules and regulations of the Secretary of Labor.

SEC. 405. This Order shall become effective thirty days after the date of this Order.

Federal Labor Standards Provisions

U.S. Department of Housing
and Urban Development
Office of Labor Relations**Applicability**

The Project or Program to which the construction work covered by this contract pertains is being assisted by the United States of America and the following Federal Labor Standards Provisions are included in this Contract pursuant to the provisions applicable to such Federal assistance.

A. 1. (i) Minimum Wages. All laborers and mechanics employed or working upon the site of the work, will be paid unconditionally and not less often than once a week, and without subsequent deduction or rebate on any account (except such payroll deductions as are permitted by regulations issued by the Secretary of Labor under the Copeland Act (29 CFR Part 3), the full amount of wages and bona fide fringe benefits (or cash equivalents thereof) due at time of payment computed at rates not less than those contained in the wage determination of the Secretary of Labor which is attached hereto and made a part hereof, regardless of any contractual relationship which may be alleged to exist between the contractor and such laborers and mechanics. Contributions made or costs reasonably anticipated for bona fide fringe benefits under Section I(b)(2) of the Davis-Bacon Act on behalf of laborers or mechanics are considered wages paid to such laborers or mechanics, subject to the provisions of 29 CFR 5.5(a)(1)(iv); also, regular contributions made or costs incurred for more than a weekly period (but not less often than quarterly) under plans, funds, or programs, which cover the particular weekly period, are deemed to be constructively made or incurred during such weekly period.

Such laborers and mechanics shall be paid the appropriate wage rate and fringe benefits on the wage determination for the classification of work actually performed, without regard to skill, except as provided in 29 CFR 5.5(a)(4). Laborers or mechanics performing work in more than one classification may be compensated at the rate specified for each classification for the time actually worked therein: Provided, That the employer's payroll records accurately set forth the time spent in each classification in which work is performed. The wage determination (including any additional classification and wage rates conformed under 29 CFR 5.5(a)(1)(ii) and the Davis-Bacon poster (WH-1321) shall be posted at all times by the contractor and its subcontractors at the site of the work in a prominent and accessible, place where it can be easily seen by the workers.

(ii) (a) Any class of laborers or mechanics which is not listed in the wage determination and which is to be employed under the contract shall be classified in conformance with the wage determination. HUD shall approve an additional classification and wage rate and fringe benefits therefor only when the following criteria have been met:

(1) The work to be performed by the classification requested is not performed by a classification in the wage determination; and

(2) The classification is utilized in the area by the construction industry; and

(3) The proposed wage rate, including any bona fide fringe benefits, bears a reasonable relationship to the wage rates contained in the wage determination.

(b) If the contractor and the laborers and mechanics to be employed in the classification (if known), or their representatives, and HUD or its designee agree on the classification and wage rate (including the amount designated for fringe benefits where appropriate), a report of the action taken shall be sent by HUD or its designee to the Administrator of the Wage and Hour Division, Employment Standards Administration, U.S. Department of Labor, Washington, D.C. 20210. The Administrator, or an authorized representative, will approve, modify, or disapprove every additional classification action within 30 days of receipt and so advise HUD or its designee or will notify HUD or its designee within the 30-day period that additional time is necessary. (Approved by the Office of Management and Budget under OMB control number 1215-0140.)

(c) In the event the contractor, the laborers or mechanics to be employed in the classification or their representatives, and HUD or its designee do not agree on the proposed classification and wage rate (including the amount designated for fringe benefits, where appropriate), HUD or its designee shall refer the questions, including the views of all interested parties and the recommendation of HUD or its designee, to the Administrator for determination. The Administrator, or an authorized representative, will issue a determination within 30 days of receipt and so advise HUD or its designee or will notify HUD or its designee within the 30-day period that additional time is necessary. (Approved by the Office of Management and Budget under OMB Control Number 1215-0140.)

(d) The wage rate (including fringe benefits where appropriate) determined pursuant to subparagraphs (1)(ii)(b) or (c) of this paragraph, shall be paid to all workers performing work in the classification under this contract from the first day on which work is performed in the classification.

(iii) Whenever the minimum wage rate prescribed in the contract for a class of laborers or mechanics includes a fringe benefit which is not expressed as an hourly rate, the contractor shall either pay the benefit as stated in the wage determination or shall pay another bona fide fringe benefit or an hourly cash equivalent thereof.

(iv) If the contractor does not make payments to a trustee or other third person, the contractor may consider as part

of the wages of any laborer or mechanic the amount of any costs reasonably anticipated in providing bona fide fringe benefits under a plan or program, Provided, That the Secretary of Labor has found, upon the written request of the contractor, that the applicable standards of the Davis-Bacon Act have been met. The Secretary of Labor may require the contractor to set aside in a separate account assets for the meeting of obligations under the plan or program. (Approved by the Office of Management and Budget under OMB Control Number 1215-0140.)

2. Withholding. HUD or its designee shall upon its own action or upon written request of an authorized representative of the Department of Labor withhold or cause to be withheld from the contractor under this contract or any other Federal contract with the same prime contractor, or any other Federally-assisted contract subject to Davis-Bacon prevailing wage requirements, which is held by the same prime contractor so much of the accrued payments or advances as may be considered necessary to pay laborers and mechanics, including apprentices, trainees and helpers, employed by the contractor or any subcontractor the full amount of wages required by the contract. In the event of failure to pay any laborer or mechanic, including any apprentice, trainee or helper, employed or working on the site of the work, all or part of the wages required by the contract, HUD or its designee may, after written notice to the contractor, sponsor, applicant, or owner, take such action as may be necessary to cause the suspension of any further payment, advance, or guarantee of funds until such violations have ceased. HUD or its designee may, after written notice to the contractor, disburse such amounts withheld for and on account of the contractor or subcontractor to the respective employees to whom they are due. The Comptroller General shall make such disbursements in the case of direct Davis-Bacon Act contracts.

3. (i) Payrolls and basic records. Payrolls and basic records relating thereto shall be maintained by the contractor during the course of the work preserved for a period of three years thereafter for all laborers and mechanics working at the site of the work. Such records shall contain the name, address, and social security number of each such worker, his or her correct classification, hourly rates of wages paid (including rates of contributions or costs anticipated for bona fide fringe benefits or cash equivalents thereof of the types described in Section 1(b)(2)(B) of the Davis-bacon Act), daily and weekly number of hours worked, deductions made and actual wages paid. Whenever the Secretary of Labor has found under 29 CFR 5.5 (a)(1)(iv) that the wages of any laborer or mechanic include the amount of any costs reasonably anticipated in providing benefits under a plan or program described in Section 1(b)(2)(B) of the Davis-Bacon Act, the contractor shall maintain records which show that the commitment to provide such benefits is enforceable, that the plan or program is financially responsible, and that the plan or program has been

communicated in writing to the laborers or mechanics affected, and records which show the costs anticipated or the actual cost incurred in providing such benefits. Contractors employing apprentices or trainees under approved programs shall maintain written evidence of the registration of apprenticeship programs and certification of trainee programs, the registration of the apprentices and trainees, and the ratios and wage rates prescribed in the applicable programs. (Approved by the Office of Management and Budget under OMB Control Numbers 1215-0140 and 1215-0017.)

(ii) (a) The contractor shall submit weekly for each week in which any contract work is performed a copy of all payrolls to HUD or its designee if the agency is a party to the contract, but if the agency is not such a party, the contractor will submit the payrolls to the applicant sponsor, or owner, as the case may be, for transmission to HUD or its designee. The payrolls submitted shall set out accurately and completely all of the information required to be maintained under 29 CFR 5.5(a)(3)(i) except that full social security numbers and home addresses shall not be included on weekly transmittals. Instead the payrolls shall only need to include an individually identifying number for each employee (e.g., the last four digits of the employee's social security number). The required weekly payroll information may be submitted in any form desired. Optional Form WH-347 is available for this purpose from the Wage and Hour Division Web site at <http://www.dol.gov/esa/whd/forms/wh347instr.htm> or its successor site. The prime contractor is responsible for the submission of copies of payrolls by all subcontractors. Contractors and subcontractors shall maintain the full social security number and current address of each covered worker, and shall provide them upon request to HUD or its designee if the agency is a party to the contract, but if the agency is not such a party, the contractor will submit the payrolls to the applicant sponsor, or owner, as the case may be, for transmission to HUD or its designee, the contractor, or the Wage and Hour Division of the Department of Labor for purposes of an investigation or audit of compliance with prevailing wage requirements. It is not a violation of this subparagraph for a prime contractor to require a subcontractor to provide addresses and social security numbers to the prime contractor for its own records, without weekly submission to HUD or its designee. (Approved by the Office of Management and Budget under OMB Control Number 1215-0149.)

(b) Each payroll submitted shall be accompanied by a "Statement of Compliance," signed by the contractor or subcontractor or his or her agent who pays or supervises the payment of the persons employed under the contract and shall certify the following:

(1) That the payroll for the payroll period contains the information required to be provided under 29 CFR 5.5 (a)(3)(ii), the appropriate information is being maintained under 29 CFR 5.5(a)(3)(i), and that such information is correct and complete;

(2) That each laborer or mechanic (including each helper, apprentice, and trainee) employed on the contract during the payroll period has been paid the full weekly wages earned, without rebate, either directly or indirectly, and that no deductions have been made either directly or indirectly from the full wages earned, other than permissible deductions as set forth in 29 CFR Part 3;

(3) That each laborer or mechanic has been paid not less than the applicable wage rates and fringe benefits or cash equivalents for the classification of work performed, as specified in the applicable wage determination incorporated into the contract.

(c) The weekly submission of a properly executed certification set forth on the reverse side of Optional Form WH-347 shall satisfy the requirement for submission of the "Statement of Compliance" required by subparagraph A.3.(ii)(b).

(d) The falsification of any of the above certifications may subject the contractor or subcontractor to civil or criminal prosecution under Section 1001 of Title 18 and Section 231 of Title 31 of the United States Code.

(iii) The contractor or subcontractor shall make the records required under subparagraph A.3.(i) available for inspection, copying, or transcription by authorized representatives of HUD or its designee or the Department of Labor, and shall permit such representatives to interview employees during working hours on the job. If the contractor or subcontractor fails to submit the required records or to make them available, HUD or its designee may, after written notice to the contractor, sponsor, applicant or owner, take such action as may be necessary to cause the suspension of any further payment, advance, or guarantee of funds. Furthermore, failure to submit the required records upon request or to make such records available may be grounds for debarment action pursuant to 29 CFR 5.12.

4. Apprentices and Trainees.

(i) **Apprentices.** Apprentices will be permitted to work at less than the predetermined rate for the work they performed when they are employed pursuant to and individually registered in a bona fide apprenticeship program registered with the U.S. Department of Labor, Employment and Training Administration, Office of Apprenticeship Training, Employer and Labor Services, or with a State Apprenticeship Agency recognized by the Office, or if a person is employed in his or her first 90 days of probationary employment as an apprentice in such an apprenticeship program, who is not individually registered in the program, but who has been certified by the Office of Apprenticeship Training, Employer and Labor Services or a State Apprenticeship Agency (where appropriate) to be eligible for probationary employment as an apprentice. The allowable ratio of apprentices to journeymen on the job site in any craft classification shall not be greater than the ratio permitted to the contractor as to the entire work force under the registered program. Any worker listed on a payroll at an apprentice wage rate, who

is not registered or otherwise employed as stated above, shall be paid not less than the applicable wage rate on the wage determination for the classification of work actually performed. In addition, any apprentice performing work on the job site in excess of the ratio permitted under the registered program shall be paid not less than the applicable wage rate on the wage determination for the work actually performed. Where a contractor is performing construction on a project in a locality other than that in which its program is registered, the ratios and wage rates (expressed in percentages of the journeyman's hourly rate) specified in the contractor's or subcontractor's registered program shall be observed. Every apprentice must be paid at not less than the rate specified in the registered program for the apprentice's level of progress, expressed as a percentage of the journeymen hourly rate specified in the applicable wage determination. Apprentices shall be paid fringe benefits in accordance with the provisions of the apprenticeship program. If the apprenticeship program does not specify fringe benefits, apprentices must be paid the full amount of fringe benefits listed on the wage determination for the applicable classification. If the Administrator determines that a different practice prevails for the applicable apprentice classification, fringes shall be paid in accordance with that determination. In the event the Office of Apprenticeship Training, Employer and Labor Services, or a State Apprenticeship Agency recognized by the Office, withdraws approval of an apprenticeship program, the contractor will no longer be permitted to utilize apprentices at less than the applicable predetermined rate for the work performed until an acceptable program is approved.

(ii) **Trainees.** Except as provided in 29 CFR 5.16, trainees will not be permitted to work at less than the predetermined rate for the work performed unless they are employed pursuant to and individually registered in a program which has received prior approval, evidenced by formal certification by the U.S. Department of Labor, Employment and Training Administration. The ratio of trainees to journeymen on the job site shall not be greater than permitted under the plan approved by the Employment and Training Administration. Every trainee must be paid at not less than the rate specified in the approved program for the trainee's level of progress, expressed as a percentage of the journeyman hourly rate specified in the applicable wage determination. Trainees shall be paid fringe benefits in accordance with the provisions of the trainee program. If the trainee program does not mention fringe benefits, trainees shall be paid the full amount of fringe benefits listed on the wage determination unless the Administrator of the Wage and Hour Division determines that there is an apprenticeship program associated with the corresponding journeyman wage rate on the wage determination which provides for less than full fringe benefits for apprentices. Any employee listed on the payroll at a trainee rate who is not registered and participating in a training plan approved by

the Employment and Training Administration shall be paid not less than the applicable wage rate on the wage determination for the work actually performed. In addition, any trainee performing work on the job site in excess of the ratio permitted under the registered program shall be paid not less than the applicable wage rate on the wage determination for the work actually performed. In the event the Employment and Training Administration withdraws approval of a training program, the contractor will no longer be permitted to utilize trainees at less than the applicable predetermined rate for the work performed until an acceptable program is approved.

(iii) Equal employment opportunity. The utilization of apprentices, trainees and journeymen under 29 CFR Part 5 shall be in conformity with the equal employment opportunity requirements of Executive Order 11246, as amended, and 29 CFR Part 30.

5. Compliance with Copeland Act requirements. The contractor shall comply with the requirements of 29 CFR Part 3 which are incorporated by reference in this contract

6. Subcontracts. The contractor or subcontractor will insert in any subcontracts the clauses contained in subparagraphs 1 through 11 in this paragraph A and such other clauses as HUD or its designee may by appropriate instructions require, and a copy of the applicable prevailing wage decision, and also a clause requiring the subcontractors to include these clauses in any lower tier subcontracts. The prime contractor shall be responsible for the compliance by any subcontractor or lower tier subcontractor with all the contract clauses in this paragraph.

7. Contract termination; debarment. A breach of the contract clauses in 29 CFR 5.5 may be grounds for termination of the contract and for debarment as a contractor and a subcontractor as provided in 29 CFR 5.12.

8. Compliance with Davis-Bacon and Related Act Requirements. All rulings and interpretations of the Davis-Bacon and Related Acts contained in 29 CFR Parts 1, 3, and 5 are herein incorporated by reference in this contract

9. Disputes concerning labor standards. Disputes arising out of the labor standards provisions of this contract shall not be subject to the general disputes clause of this contract. Such disputes shall be resolved in accordance with the procedures of the Department of Labor set forth in 29 CFR Parts 5, 6, and 7. Disputes within the meaning of this clause include disputes between the contractor (or any of its subcontractors) and HUD or its designee, the U.S. Department of Labor, or the employees or their representatives.

10. (i) Certification of Eligibility. By entering into this contract the contractor certifies that neither it (nor he or she) nor any person or firm who has an interest in the contractor's firm is a person or firm ineligible to be awarded Government contracts by virtue of Section 3(a) of the Davis-Bacon Act or 29 CFR 5.12(a)(1) or to be

awarded HUD contracts or participate in HUD programs pursuant to 24 CFR Part 24.

(ii) No part of this contract shall be subcontracted to any person or firm ineligible for award of a Government contract by virtue of Section 3(a) of the Davis-Bacon Act or 29 CFR 5.12(a)(1) or to be awarded HUD contracts or participate in HUD programs pursuant to 24 CFR Part 24.

(iii) The penalty for making false statements is prescribed in the U.S. Criminal Code, 18 U.S.C. 1001. Additionally, U.S. Criminal Code, Section 1 01 0, Title 18, U.S.C., "Federal Housing Administration transactions", provides in part: "Whoever, for the purpose of . . . influencing in any way the action of such Administration..... makes, utters or publishes any statement knowing the same to be false..... shall be fined not more than \$5,000 or imprisoned not more than two years, or both."

11. Complaints, Proceedings, or Testimony by Employees. No laborer or mechanic to whom the wage, salary, or other labor standards provisions of this Contract are applicable shall be discharged or in any other manner discriminated against by the Contractor or any subcontractor because such employee has filed any complaint or instituted or caused to be instituted any proceeding or has testified or is about to testify in any proceeding under or relating to the labor standards applicable under this Contract to his employer.

B. Contract Work Hours and Safety Standards Act. The provisions of this paragraph B are applicable where the amount of the prime contract exceeds \$100,000. As used in this paragraph, the terms "laborers" and "mechanics" include watchmen and guards.

(1) Overtime requirements. No contractor or subcontractor contracting for any part of the contract work which may require or involve the employment of laborers or mechanics shall require or permit any such laborer or mechanic in any workweek in which the individual is employed on such work to work in excess of 40 hours in such workweek unless such laborer or mechanic receives compensation at a rate not less than one and one-half times the basic rate of pay for all hours worked in excess of 40 hours in such workweek.

(2) Violation; liability for unpaid wages; liquidated damages. In the event of any violation of the clause set forth in subparagraph (1) of this paragraph, the contractor and any subcontractor responsible therefor shall be liable for the unpaid wages. In addition, such contractor and subcontractor shall be liable to the United States (in the case of work done under contract for the District of Columbia or a territory, to such District or to such territory), for liquidated damages. Such liquidated damages shall be computed with respect to each individual laborer or mechanic, including watchmen and guards, employed in violation of the clause set forth in subparagraph (1) of this paragraph, in the sum of \$10 for each calendar day on which such individual was required or permitted to work in excess of the standard workweek of 40 hours without payment of the overtime wages required by the clause set forth in subparagraph (1) of this paragraph.

(3) Withholding for unpaid wages and liquidated damages. HUD or its designee shall upon its own action or upon written request of an authorized representative of the Department of Labor withhold or cause to be withheld, from any moneys payable on account of work performed by the contractor or subcontractor under any such contract or any other Federal contract with the same prime contract, or any other Federally-assisted contract subject to the Contract Work Hours and Safety Standards Act which is held by the same prime contractor such sums as may be determined to be necessary to satisfy any liabilities of such contractor or subcontractor for unpaid wages and liquidated damages as provided in the clause set forth in subparagraph (2) of this paragraph.

(4) Subcontracts. The contractor or subcontractor shall insert in any subcontracts the clauses set forth in subparagraph (1) through (4) of this paragraph and also a clause requiring the subcontractors to include these clauses in any lower tier subcontracts. The prime contractor shall be responsible for compliance by any subcontractor or lower tier subcontractor with the clauses set forth in subparagraphs (1) through (4) of this paragraph.

C. Health and Safety. The provisions of this paragraph C are applicable where the amount of the prime contract exceeds \$100,000.

(1) No laborer or mechanic shall be required to work in surroundings or under working conditions which are unsanitary, hazardous, or dangerous to his health and safety as determined under construction safety and health standards promulgated by the Secretary of Labor by regulation.

(2) The Contractor shall comply with all regulations issued by the Secretary of Labor pursuant to Title 29 Part 1926 and failure to comply may result in imposition of sanctions pursuant to the Contract Work Hours and Safety Standards Act, (Public Law 91-54, 83 Stat 96). 40 USC 3701 et seq.

(3) The contractor shall include the provisions of this paragraph in every subcontract so that such provisions will be binding on each subcontractor. The contractor shall take such action with respect to any subcontractor as the Secretary of Housing and Urban Development or the Secretary of Labor shall direct as a means of enforcing such provisions.

HUD REQUIRED GENERAL CONTRACTOR AND SUB-CONTRACTOR FORMS

THESE FORMS WILL NEED TO BE COMPLETED BY THE SUCCESSFUL BIDDER(S)

- ❑ Notification to the Office of Federal Contract Compliance Programs: This form applies to the successful bidder(s) and all subcontractors with contracts of \$10,000 or greater. Mail this form to U.S. Department of Labor. Copies to Owner and DuPage County.

ORIGINALS OF ALL OF THE FOLLOWING FORMS MUST BE SENT TO OWNER

- ❑ Ownership Form
- ❑ Contractor / Subcontractor Labor Relations Agreement
- ❑ Apprenticeship Policy Recognition Form
- ❑ Section 3 Forms
 - Complete as applicable
- ❑ Certified Payroll (Weekly Reports) (Two page form with payroll on first page and statement of compliance on second page.)

Note: DuPage County Community Development Commission (CDC) is the DuPage County office responsible for administering HUD funds. This project is funded in whole or part via a grant of HUD funds from DuPage County to the Owner / Subgrantee.

Informational Materials Attached: Sample Labor Relations Agreement; Section 3 Initiative and Compliance summary; Instructions for Completing Certified Payrolls and Statement of Compliance; Categorizing Foremen, Supervisors, Owners, and Other Employees on Certified Payrolls; Sample Payroll; Sample Statement of Compliance.

HUD = United States Department of Housing and Urban Development

OWNERSHIP FORM

(To be completed by business owners)

Any contractor working on a federally funded project must be cleared through the Excluded Parties List System (EPLS) for identifying businesses and individuals that have been debarred or are otherwise ineligible to be paid with federal funds. Please complete this information so that such clearance may be performed by CDC staff.

PART 1 Business Information:

Legal Business Name			
Owner Name			
Address of Business			
Telephone #		DUNS #	
Webpage (if available)		FIN (IRS) #	
Trade(s)			

Indicate whether business is:

- Sole Proprietorship _____ Date Established: _____ BRC² _____
- Limited Liability Company _____
- Partnership _____ Date of Agreement: _____ BRC _____
- Corporation¹ _____ Date of Incorporation: _____ TIN³ _____

¹ Does not include affiliates, wholly owned subsidiaries or divisions.

² Business Registration Certificate Number

³ Tax Identification Number

Has the firm done or is it currently doing business under another name?

Yes: _____ No: _____

If yes, please provide the name and explain:

Is the spouse of the owner also involved in the business in any capacity (Vice President, secretary, etc)?

Yes: _____ No: _____

If yes, please provide name and the title of the spouse:

Identify the names of all owners/principals of the company:

Name	Title	Business Name (if applicable)

Is the firm in Good Standing with the State of Illinois? (This will be confirmed by CDC through a check of CyberDrive Illinois.)

Yes: _____ No: _____

If no, please explain:

PART 2 Other Concerns:

<input type="checkbox"/>	Business is owned by a minority person:	<input type="checkbox"/> African American	<input type="checkbox"/> Hispanic American
	<input type="checkbox"/> Other (Specify):	<input type="checkbox"/> Native American	<input type="checkbox"/> Asian/Pacific American

Business is woman owned.

I certify that the above information is complete and accurate.

Owner Signature

Date

Print Name

Title

NOTIFICATION TO THE OFFICE OF FEDERAL
CONTRACT COMPLIANCE PROGRAMS (OFCCP)

To be completed and mailed within 10 business days of contract signing. Send original to the Office of Federal Contract Compliance and photocopy to DuPage County Address at bottom of letter.

Date: _____

Michael Thomas, District Director
Office of Federal Contract Compliance Programs
U.S. Department of Labor – Employment Standards Administration
Chicago District Office
230 S. Dearborn St., Room 434
Chicago, IL 60604

Please be advised that the following contract in excess of \$10,000 has been awarded:

Program: _____

Contractor: _____

Contractor Address: _____

Contractor Telephone: _____

Contractor Employer ID Number: _____

\$ Amount of Contract: _____

Construction Start Date: _____

Construction Completion Date: _____

Project No. _____

Project Location: _____

Signed: _____

Printed Name: _____

Title: _____

CC: DuPage County Community Development
421 N. County Farm Rd, Room 3-100
Wheaton, IL 60187

CC: _____

Attn: _____

Attn: _____

CONTRACTOR/SUBCONTRACTOR LABOR RELATIONS AGREEMENT (LRA)

Project Name	Non-Profit Agency New Facility Construction	Project #	CD13-01
Project Address	1 Main Street, Town, IL 60000	Contract Amount	100,000
Contractor Name	Jones Construction Company	Type	<input type="checkbox"/> GC <input checked="" type="checkbox"/> Subcontractor
<i>If SUBCONTRACTOR provide name of contracting company</i>		Tom's General Contracting Company	
Address of Business	123 Main Street, Town, IL 60000		
Contact Person	Samuel Jones	Title	Owner/President
Telephone #	111-111-1111	Fax #	222-222-2222
Email Address	sam.jones@jonesco.com	FIN (IRS) #	12-3456789

1. Is the contractor named above supplying materials only? No (continue to question 2.) Yes (Material suppliers do not have to complete this form, but any labor subcontractors hired for installation of these materials must be disclosed and must complete all HUD forms.)

2. The following persons are hereby authorized to complete and sign all payroll forms and records for the above project:

Name/Title:	Samuel Jones / Owner/President	Signature:	<i>Samuel Jones</i>
Name/Title:	Jane Jones / Payroll Administrator	Signature:	<i>Jane Jones</i>

3. I HAVE HAVE NOT received a copy of the applicable Davis-Bacon wage rates for the above project and I understand that Federal Prevailing Wage Rates apply to this project.

4. In the section below, please list the hourly wage and fringe benefits by job classification and group number of each trade employed by your company. Mark how benefits are paid. Total wages must meet Davis-Bacon minimums.

Job Classification # (for DuPage)	CARP0555-005 (Building)
Group # (if applicable)	n/a
Hourly Wage Rate:	\$41.52
Hourly Fringe Benefits:	\$25.47
<i>Fringe Benefits paid</i>	<input type="checkbox"/> in cash <input checked="" type="checkbox"/> into plan(s)
TOTAL (wages + fringe)	\$66.99

Job Classification # (for DuPage)	LABO0002-003
Group # (if applicable)	1
Hourly Wage Rate:	\$35.20
Hourly Fringe Benefits:	\$21.45
<i>Fringe Benefits paid</i>	<input type="checkbox"/> in cash <input checked="" type="checkbox"/> into plan(s)
TOTAL (wages + fringe)	\$56.65

Job Classification # (for DuPage)	
Group # (if applicable)	
Hourly Wage Rate:	
Hourly Fringe Benefits:	
<i>Fringe Benefits paid</i>	<input type="checkbox"/> in cash <input type="checkbox"/> into plan(s)
TOTAL (wages + fringe)	\$0.00

Job Classification # (for DuPage)	
Group # (if applicable)	
Hourly Wage Rate:	
Hourly Fringe Benefits:	
<i>Fringe Benefits paid</i>	<input type="checkbox"/> in cash <input type="checkbox"/> into plan(s)
TOTAL (wages + fringe)	\$0.00

Job Classification # (for DuPage)	
Group # (if applicable)	
Hourly Wage Rate:	
Hourly Fringe Benefits:	
<i>Fringe Benefits paid</i>	<input type="checkbox"/> in cash <input type="checkbox"/> into plan(s)
TOTAL (wages + fringe)	\$0.00

Job Classification # (for DuPage)	
Group # (if applicable)	
Hourly Wage Rate:	
Hourly Fringe Benefits:	
<i>Fringe Benefits paid</i>	<input type="checkbox"/> in cash <input type="checkbox"/> into plan(s)
TOTAL (wages + fringe)	\$0.00

WARNING: U.S. CRIMINAL CODE, SECTION 1010, TITLE 18, U.S.C., PROVIDES IN PART: "WHOEVER...MAKES, PASSES, UTTERS, OR PUBLISHES ANY STATEMENT, KNOWING THE SAME TO BE FALSE...SHALL BE FINED NOT MORE THAN \$5,000 OR IMPRISONED NOT MORE THAN TWO YEARS, OR BOTH."

The undersigned certifies that (s)he is an owner/officer of the contractor and further certifies compliance with all Federal EEO requirements:

Samuel Jones 04/01/2013
Signature Date
Samuel Jones Owner/President
Print Name Title

CONTRACTOR/SUBCONTRACTOR LABOR RELATIONS AGREEMENT (LRA)

Project Name	Project Name	Project #	
Project Address		Contract Amount	
Contractor Name		Type	<input type="checkbox"/> GC <input type="checkbox"/> Subcontractor
<i>If SUBCONTRACTOR provide name of contracting company</i>			
Address of Business			
Contact Person		Title	
Telephone #		Fax #	
Email Address		FIN (IRS) #	

1. Is the contractor named above supplying materials only? No (continue to question 2.) Yes (Material suppliers do not have to complete this form, but any labor subcontractors hired for installation of these materials must be disclosed and must complete all HUD forms.)

2. The following persons are hereby authorized to complete and sign all payroll forms and records for the above project:

Name/Title:		Signature:	
Name/Title:		Signature:	

3. I **HAVE** **HAVE NOT** received a copy of the applicable Davis-Bacon wage rates for the above project and I understand that Federal Prevailing Wage Rates apply to this project.

4. In the section below, please list the hourly wage and fringe benefits by job classification and group number of each trade employed by your company. Mark how benefits are paid. Total wages must meet Davis-Bacon minimums.

Job Classification # (for DuPage)	
Group # (if applicable)	
Hourly Wage Rate:	
Hourly Fringe Benefits:	
<i>Fringe Benefits paid</i>	<input type="checkbox"/> in cash <input type="checkbox"/> into plan(s)
TOTAL (wages + fringe)	\$0.00

Job Classification # (for DuPage)	
Group # (if applicable)	
Hourly Wage Rate:	
Hourly Fringe Benefits:	
<i>Fringe Benefits paid</i>	<input type="checkbox"/> in cash <input type="checkbox"/> into plan(s)
TOTAL (wages + fringe)	\$0.00

Job Classification # (for DuPage)	
Group # (if applicable)	
Hourly Wage Rate:	
Hourly Fringe Benefits:	
<i>Fringe Benefits paid</i>	<input type="checkbox"/> in cash <input type="checkbox"/> into plan(s)
TOTAL (wages + fringe)	\$0.00

Job Classification # (for DuPage)	
Group # (if applicable)	
Hourly Wage Rate:	
Hourly Fringe Benefits:	
<i>Fringe Benefits paid</i>	<input type="checkbox"/> in cash <input type="checkbox"/> into plan(s)
TOTAL (wages + fringe)	\$0.00

Job Classification # (for DuPage)	
Group # (if applicable)	
Hourly Wage Rate:	
Hourly Fringe Benefits:	
<i>Fringe Benefits paid</i>	<input type="checkbox"/> in cash <input type="checkbox"/> into plan(s)
TOTAL (wages + fringe)	\$0.00

Job Classification # (for DuPage)	
Group # (if applicable)	
Hourly Wage Rate:	
Hourly Fringe Benefits:	
<i>Fringe Benefits paid</i>	<input type="checkbox"/> in cash <input type="checkbox"/> into plan(s)
TOTAL (wages + fringe)	\$0.00

WARNING: U.S. CRIMINAL CODE, SECTION 1010, TITLE 18, U.S.C., PROVIDES IN PART: "WHOEVER...MAKES, PASSES, UTTERS, OR PUBLISHES ANY STATEMENT, KNOWING THE SAME TO BE FALSE...SHALL BE FINED NOT MORE THAN \$5,000 OR IMPRISONED NOT MORE THAN TWO YEARS, OR BOTH."

The undersigned certifies that (s)he is an owner/officer of the contractor and further certifies compliance with all Federal EEO requirements:

_____ Signature	_____ Date
_____ Print Name	_____ Title

APPRENTICESHIP POLICY RECOGNITION FORM

This form has been provided by the DuPage Community Development Commission (CDC) for the contractor's benefit to fully understand the requirements that surround the use of apprentices and trainees on federally funded projects. You are encouraged by the CDC to assign apprentices to this project and this document discloses key requirements that will help contractors avoid infractions which necessitate wage restitution. By filling out this form, you are only demonstrating your awareness of the policies regarding apprentices and government work. After completing this form, please return it to the property owner to hand into to the CDC.

Project Name	Project Name	Project #	
Project Address		Contract Amount	
Contractor Name		Type	<input type="checkbox"/> GC <input type="checkbox"/> Subcontractor
<i>If SUBCONTRACTOR provide name of contracting company</i>			
Address of Business			
Contact Person		Title	
Telephone #		Fax #	
Email Address		FIN (IRS) #	

Federal regulations stipulate that apprentices and trainees (hereinafter "apprentices") assigned to a federally funded project are required to be accompanied by a qualified journeyman worker of the same trade. This means that apprentices are not to perform work on the *project* without proper supervision. Superintendents, company inspectors, managing supervisors, foremen, or any other person employed as contractor administration, do not qualify as a labor-mentoring agent. On each certified payroll, a journeyman's hours must match an apprentice's hours each day. There are no exceptions to this policy.

Should an apprentice perform work *alone* on the premises of the above stated project, Davis-Bacon Wage Determinations will apply and the apprentice must be paid the minimum prevailing wage for his or her time. Restitution must be paid to the employee in the manner of the difference between the prevailing wage and the apprentice's wage.

Do you plan on using apprentices for the above referenced project?	<input type="checkbox"/> Yes	<input type="checkbox"/> No
Are your apprentices registered with the Bureau of Apprenticeship and Training?	<input type="checkbox"/> Yes	<input type="checkbox"/> No

If not, you must register all apprentices with the Bureau. You can reach the local office at: (312) 596-5500. Return evidence of registration to the property owner.

List below the names and status of the apprentices likely planned for work on this project. Listing does not bind the contractor to assigning these apprentices and trainees:

Apprentice/Trainee Name	Year/Level	Registered	Wage/hour

I am now fully aware of the federal apprentice/trainee policies involving the above referenced project and will keep a copy of this disclaimer in the project file:

_____ Signature	_____ Date
_____ Print Name	_____ Title

DU PAGE COUNTY SECTION 3 INITIATIVE AND COMPLIANCE

Federal grant funds awarded by DuPage County to this project are subject to Section 3 compliance as provided in 24 CFR Part 135. The purpose of Section 3 is to ensure that employment and economic opportunities shall, to the greatest extent feasible, and consistent with existing Federal, State, and local laws and regulations, be directed to low-income persons and business concerns which provide opportunities for low-income persons. Section 3 designation is a person whose household income is 80% or less of area median family income (hereinafter, "low-income" or "Section 3 resident"). All contractors providing labor are subject to Section 3 and must complete the following documents (as applicable):

- 0) SECTION 3 CLAUSE: Acknowledgement to be signed by all Section 3 covered contractors (must be signed if the contract is over \$100,000).
- 1) FEDERAL SECTION 3 BUSINESS CONCERN SELF CERTIFICATION (FORM 1): To be completed by all contractors. Describes contractors' Section 3 status based on the following categories:
 - A. Business owned by Section 3 resident;
 - B. 30% of permanent full-time employees are Section 3 residents;
 - C. Subcontract 25% of award amount to Section 3 Business Concerns.
- 2) FEDERAL SECTION 3 RESIDENT SELF CERTIFICATION (FORM 2): To be completed by all business owners claiming Section 3 under category A and/or all Section 3 employees working on this project (Section 3 family income limits are included on the form);
- 3) PERMANENT EMPLOYEE / NEW HIRES LIST (FORM 3): To be completed by all business owners claiming Section 3 under category B or hiring new employees;
- 4) FEDERAL SECTION 3 BUSINESS CONCERN SUBCONTRACTING PLAN (FORM 4): To be completed by all business owners claiming Section 3 under category C;
- 5) FEDERAL SECTION 3 BUSINESS REPORTING (FORM 5): To be completed by all contractors. Information required to complete the federal reporting requirements.

DuPage County is responsible for executing compliance and reporting the outcomes of these efforts. Specifically, under this regulation, DuPage County is responsible for:

- 1) Informing any tier of subrecipients, developers, general contractors, contractors, and subcontractors of the requirements of Part 135;
- 2) Monitor the performance of all tiers in respect to the requirements and objectives of Part 135;
- 3) Notify potential contractors and subcontractors of Section 3 covered opportunities open for bid; and
- 4) Collect and report documentation in respect to all efforts made by tiers to achieve Section 3 participation.

Tiers receiving contracts greater than \$100,000 are covered by Section 3. As related to this project, and to the greatest extent feasible, these tiers are responsible for:

- 1) Contracting or hiring locally
- 2) Contracting at least 10% of the total project cost with Section 3 business concerns
 - a. Businesses which are majority owned by low-income persons qualify
 - b. Businesses which employ at least 30% full-time low-income employees qualify
 - c. Businesses which offer 25% of all subcontracts to Section 3 businesses qualify
- 3) Hiring, at least 30% of all new employees from low-income households
- 4) Refraining from entering into contracts with businesses in violation of Section 3
- 5) Documenting all efforts, actions taken, results, and/or impediments to achieving Section 3 obligations for submission to the DuPage Community Development Commission

Any tier contracting for \$100,000 or less is not responsible for complying with Section 3; however, it is encouraged that any contractor or new hire which qualifies as Section 3 be documented and reported to meet the numerical objectives as a whole.

Noncompliance involving the disregard of actions to be taken and/or documentation of those efforts, whether successful or not, may result in delayed or non-payment of Federal grant awards.

For more information about Section 3 and to access DuPage County's Section 3 certification forms, visit: http://www.dupageco.org/Community_Services/Community_Development_Commission/31074/

SECTION 3 CLAUSE

The requirements of Section 3 apply to contractors and subcontractors performing work on construction or rehabilitation projects for which the contract/subcontract amount exceeds \$100,000. Any tier contracting for \$100,000 or less is not required to comply; however, it is strongly encouraged.

TITLE 24 PART 135 ECONOMIC OPPORTUNITIES FOR LOW - AND VERY LOW - INCOME PERSONS
135.38 - Section 3 clause

All section 3 covered contracts shall include the following clause (referred to as the section 3 clause):

- A. The work to be performed under this contract is subject to the requirements of section 3 of the Housing and Urban Development Act of 1968, as amended, 12 U.S.C. 1701u (section 3). The purpose of section 3 is to ensure that employment and other economic opportunities generated by HUD assistance or HUD-assisted projects covered by section 3, shall, to the greatest extent feasible, be directed to low- and very low-income persons, particularly persons who are recipients of HUD assistance for housing.
- B. The parties to this contract agree to comply with HUD's regulations in 24 CFR part 135, which implement section 3. As evidenced by their execution of this contract, the parties to this contract certify that they are under no contractual or other impediment that would prevent them from complying with the part 135 regulations.
- C. The contractor agrees to send to each labor organization or representative of workers with which the contractor has a collective bargaining agreement or other understanding, if any, a notice advising the labor organization or workers' representative of the contractor's commitments under this section 3 clause, and will post copies of the notice in conspicuous places at the work site where both employees and applicants for training and employment positions can see the notice. The notice shall describe the section 3 preference, shall set forth minimum number and job titles subject to hire, availability of apprenticeship and training positions, the qualifications for each; and the name and location of the person(s) taking applications for each of the positions; and the anticipated date the work shall begin.
- D. The contractor agrees to include this section 3 clause in every subcontract subject to compliance with regulations in 24 CFR part 135, and agrees to take appropriate action, as provided in an applicable provision of the subcontract or in this section 3 clause, upon a finding that the subcontractor is in violation of the regulations in 24 CFR part 135. The contractor will not subcontract with any subcontractor where the contractor has notice or knowledge that the subcontractor has been found in violation of the regulations in 24 CFR part 135.
- E. The contractor will certify that any vacant employment positions, including training positions, that are filled (1) after the contractor is selected but before the contract is executed, and (2) with persons other than those to whom the regulations of 24 CFR part 135 require employment opportunities to be directed, were not filled to circumvent the contractor's obligations under 24 CFR part 135.
- F. Noncompliance with HUD's regulations in 24 CFR part 135 may result in sanctions, termination of this contract for default, and debarment or suspension from future HUD assisted contracts.
- G. With respect to work performed in connection with section 3 covered Indian housing assistance, section 7(b) of the Indian Self-Determination and Education Assistance Act (25 U.S.C. 450e) also applies to the work to be performed under this contract. Section 7(b) requires that to the greatest extent feasible (i) preference and opportunities for training and employment shall be given to Indians, and (ii) preference in the award of contracts and subcontracts shall be given to Indian organizations and Indian-owned Economic Enterprises. Parties to this contract that are subject to the provisions of section 3 and section 7(b) agree to comply with section 3 to the maximum extent feasible, but not in derogation of compliance with section 7(b).

The undersigned agrees to comply with the Section 3 Guidelines when applicable as referenced by HUD regulations in 24 CFR per 135 as amended.

Authorized Signature Date

Print Title

Business Name

FEDERAL SECTION 3 BUSINESS CONCERN SELF CERTIFICATION (Form 1)

(To be completed by business owners)

PART 1 Business Concern Information:

Legal Business Name			
Address of Business			
Contact Person		Title	
Telephone #		Fax #	
Email Address		FIN (IRS) #	
Trade(s)			

Business Partners/Owners Name	Title	Address

PART 2 Section 3 Federal Business Concern: The above business certifies that it qualifies as a Section 3 Business Concern based on: *(Please check the appropriate category below and provide requested supporting forms)*

A Business is majority owned (at least 51%) by Section 3 Resident(s).
 Must provide signed *Federal Section 3 Resident Self Certification (Form 2)* for the owner(s)

or

B At least 30% of the permanent, full-time employees are currently Section 3 Residents or were Section 3 Residents within the past 3 years.
 Must provide *Permanent Employee / New Hire List (Form 3)*; and
 Must provide *Federal Section 3 Resident Self Certifications (Form 2)* for all owners and Section 3 employees

or

C Commitment to subcontract 25% of the dollar award to qualified Section 3 Business Concerns if awarded contract
 Must provide signed *Federal Section 3 Subcontracting Plan (Form 4)*; and
 Must provide signed *Federal Section 3 Business Concern Self Certifications (Form 1)* for all subcontractors

D Check "D" if none of the categories above apply to your business.

PART 3 Other Business Concern:

Business is owned by a minority person: African American Hispanic American
 Other (Specify): _____ Native American Asian/Pacific American

Business is woman owned.

PART 4 Business Owner Certification: This certification is valid for a period of 3 years (PLEASE READ CAREFULLY)

I authorize the information above to be added to a database of Section 3 Business Concerns that will enable my business to receive notice of contracting opportunities for future Section 3 covered projects. I understand that the Section 3 Business Concern list may provide additional employment opportunities, however inclusion on that list does not guarantee awarding of contracts. I further understand that this list may be accessed by DuPage County staff, developers and contractors working on Section 3 covered projects. **Yes** **No**

I certify that I will ensure that Section 3 information and its requirements are provided to all employees and lower tier subcontractors involved in the project. Under penalty of perjury I also certify that to the best of my knowledge and belief, data in this form and its attachments are true and correct, and the business will comply with all regulations and guidelines applicable to DuPage County's funding programs. I agree to furnish to DuPage County any requested documentation in support of verification of this self-certification. Furthermore, I acknowledge that this form is a public document subject to the Freedom of Information Act.

Owner Signature	Date
Print Name	Title

Do Not Use Copy:
 Project # _____
 Date _____

FEDERAL SECTION 3 RESIDENT SELF CERTIFICATION (Form 2)

(To be completed by each business owner if claiming Section 3 under category A of Form 1 and/or all Section 3 employees/residents)

PART 1 Resident Information:

Name			
Home Address			
Telephone #		Email	
Name of Employer			

Job Category:	<input type="checkbox"/> Business Owner/Professional	<input type="checkbox"/> Office/Clerical
	<input type="checkbox"/> Technician	<input type="checkbox"/> Trade: _____

Employee Experience/ Training/ Job Skills:	
---	--

PART 2 Income Survey:

<i>How many persons live in your home?</i>	_____ persons
--	---------------

<i>What is the total yearly income of ALL persons, 18 years and older, living in your household?</i>	\$_____ total yearly household income
--	---------------------------------------

Note: Total yearly income means all funds (salaries, dividends, interest, etc.) received during the year, before taxes.

Please note that in order to qualify as a Section 3 Resident, the total yearly household income must be less than the 2018 Section 3 income limits listed below.

Persons in Household	1	2	3	4	5	6	7	8
80% AMI (gross income)	\$47,400	\$54,200	\$60,950	\$67,700	\$73,150	\$78,550	\$83,950	\$89,400

PART 3 Resident Certification: This certification is valid for a period of 3 years (PLEASE READ CAREFULLY)

I authorize the information above to be added to a database of Section 3 Residents that will enable me to receive notice of employment for future Section 3 covered projects. I understand the Section 3 Resident list may provide additional employment opportunities, however inclusion on that list does not guarantee employment. I further understand that this list may be accessed by DuPage County staff, developers and contractors working on Section 3 covered projects; however no personal information will be made available to the developers, contractors, or public. Yes No

Under penalty of perjury I certify that I, _____ (print name), am a legal resident of DuPage County and qualify as a Section 3 Resident because I meet the income limits as published on this form OR I am a public housing resident. I agree to furnish to DuPage County any requested documentation in support of verification of this self-certification.

Signature Date

Print Name

PERMANENT EMPLOYEE / NEW HIRES LIST (Form 3)

(To be completed by business owners if claiming Section 3 under category B of Form 1 or business owners hiring new employees)

PART 1 Business Concern Information:

Legal Business Name			
Address of Business			
Contact Person		Title	
Telephone #		Fax #	
Email Address		FIN (IRS) #	

PART 2 List all full-time employees: (Attach additional sheets as needed.)

#	Employee Name	New Hire (yes/no)	Trade	Section 3 (yes/no)*
1.				
2.				
3.				
4.				
5.				
6.				
7.				
8.				
9.				
10.				
11.				
12.				
13.				
14.				
15.				
16.				
17.				
18.				
19.				
20.				

Total number of all employees:	
---------------------------------------	--

Have you, or do you, anticipate hiring new employees for this project?	<input type="checkbox"/> Yes	<input type="checkbox"/> No
---	------------------------------	-----------------------------

* Provide Section 3 Resident Self Certification (Form 2) for all employees that qualify as Section 3 Residents. Please note that in order to qualify as a Section 3 Resident, the total yearly household income must be less than the 2018 Section 3 income limits listed below.

Persons in Household	1	2	3	4	5	6	7	8
80% AMI (gross income)	\$47,400	\$54,200	\$60,950	\$67,700	\$73,150	\$78,550	\$83,950	\$89,400

PART 3 Certification: (PLEASE READ CAREFULLY)

Under penalty of perjury I certify that I am an owner/officer of the business and further certify that to the best of my knowledge and belief, data in this form and its attachments are true and correct, and the business will comply with all regulations and guidelines applicable to DuPage County's funding programs. I agree to furnish to DuPage County any requested documentation in support of verification of this form. Furthermore, I acknowledge that this form is a public document subject to the Freedom of Information Act.

Authorized Signature	Date
Print Name	Title

FEDERAL SECTION 3 BUSINESS CONCERN SUBCONTRACTING PLAN (Form 4)
 (To be completed by business owners only if claiming Section 3 under category C of Form 1)

PART 1 Business Concern Information:

Legal Business Name			
Address of Business			
Contact Person		Title	
Telephone #		Fax #	
Email Address		FIN (IRS) #	

PART 2 Subcontractors:

Name of Subcontractor	Type of Contract (trade)	Estimated Contract Amount	Section 3 Business Concern (yes/no) *
1.			
2.			
3.			
4.			
5.			
6.			
7.			
8.			
9.			
10.			
11.			
12.			
13.			
14.			
15.			

* Provide Section 3 Business Concern Self Certification (Form 1) for all subcontractors that qualify as Section 3.

PART 3 Business Concern Contract and Subcontract(s) Amounts:

Total contract amount	\$ _____	Estimated amount to be subcontracted	\$ _____
Amount to be subcontracted to Section 3 businesses:	\$ _____	% of subcontracts that are Section 3	% _____

PART 4 Certification: (PLEASE READ CAREFULLY)

Under penalty of perjury I certify that I am an owner/officer of the business and further certify that to the best of my knowledge and belief, data in this form and its attachments are true and correct, and the business will comply with all regulations and guidelines applicable to DuPage County's funding programs. I agree to furnish to DuPage County any requested documentation in support of verification of this form. Furthermore, I acknowledge that this form is a public document subject to the Freedom of Information Act.

Signature	Date
Print	Title

FEDERAL SECTION 3 BUSINESS REPORTING (Form 5)

(To be completed by business owners - General Contractor & Subcontractors – only if awarded contract)

PART 1 Business Concern Information:

Please complete this form pertaining to the dollar amount your business has contracted for under this project.

Legal Business Name			
Address of Business			
Contact Person		Title	
Telephone #		Fax #	
Email Address		FIN (IRS) #	

Project Name		General or Subcontractor	
Contract Amount	\$ _____	Number of Subs Hired	

PART 2 Employment and Training Data:

Please provide any employment and training figures concerning New Hires and Section 3 status:

Job category	Number of New Hires	Number of Section 3 New Hires	Number of Section 3 Trainees or Apprentices
Professionals			
Technicians			
Office/Clerical			
Construction Trade (Specify below):			
Other Categories (Specify below):			

PART 3 Contracting Data:

Construction Contracts:

Total dollar amount of your contract on this project:	\$ _____
Total dollar amount subcontracted to Section 3 businesses:	\$ _____
Percentage of total dollar amount subcontracted to Section 3 businesses:	_____ %
Total number of Section 3 Certified Businesses receiving contracts:	_____

Non-construction Contracts (engineering, architectural):

Total dollar amount of non-construction contracts received on this project:	\$ _____
Total dollar amount subcontracted to non-construction Section 3 businesses:	\$ _____
Percentage of total dollar amount subcontracted to non-construction Section 3 businesses:	_____ %
Total number of non-construction Section 3 businesses receiving contracts:	_____

PART 4 Certification: (PLEASE READ CAREFULLY)

Under penalty of perjury I certify that I am an owner/officer of the business and further certify that to the best of my knowledge and belief, data in this form and its attachments are true and correct, and the business will comply with all regulations and guidelines applicable to DuPage County's funding programs. I agree to furnish to DuPage County any requested documentation in support of verification of this form. Furthermore, I acknowledge that this form is a public document subject to the Freedom of Information Act.

Authorized Signature	Date
Print	Title

CATEGORIZING FOREMEN, SUPERVISORS, OWNERS, AND OTHER EMPLOYEES ON CERTIFIED PAYROLLS

Non-labor employees on or off the jobsite need not report their wage rates, however some exceptions do apply:

Non-Covered Job Classifications

Workers performing normal duties of the following job classifications are not subject to wage requirements:

- | | |
|---------------------------|------------------------------|
| 1) Project Superintendent | 5) Water Carrier |
| 2) Project Engineer | 6) Messenger |
| 3) Project Foreman* | 7) Clerical Workers |
| 4) Watchman | 8) Other Non-Labor Employees |

* Exception is the Working Foreman. A Working Foreman is one who devotes more than 20 percent of time during a work week to mechanic or labor duties, and who must be paid the applicable rate for the hours so worked.

Supervisors, Owners, and Other Salaried Employees Providing Full-Time Supervision

- 1) Supervisors
 - a. Hours worked by these employees must be reported although wage rates need NOT be reported.
 - b. The term "Salary" may appear in place of wage rate for any salaried employee.
- 2) Owners
 - a. Owners who perform labor-work on a federally funded project along side journeymen employees must also report hours worked.
 - b. Like supervisors owners need not report salary, with exception to #3:
- 3) Self-Employed, Sole-Laborer Owners
 - a. Owners who are either the only laborer or mentoring an apprentice or trainee MUST report wage rate and weekly wage for work performed.
 - b. Certified payrolls MUST also be completed and signed by the General Contractor.

Apprentices and Trainees

- 1) Apprentices and Trainees may be paid a lower wage rate than Prevailing Wage under the following conditions:
 - a. The apprentice or trainee is supervised hour for hour by a journeyman of the same trade.
 - b. Journeyman to apprentice ratio set by the local union is maintained
 - c. Supervisors, superintendents or any other management employee does not count as appropriate supervision.
- 2) If an apprentice or trainee is found unsupervised:
 - a. Employer will be contacted by phone and mail.
 - b. Restitution to meet the Davis-Bacon wage determination for hours worked will be required.
 - c. Non-compliance can and will hold up further payouts.

INSTRUCTIONS FOR COMPLETING PAYROLL FORM, WH-347

[WH-347](#) (PDF) OMB Control No. 1235-0008, Expires 01/31/2015.

General: Form WH-347 has been made available for the convenience of contractors and subcontractors required by their Federal or Federally-aided construction-type contracts and subcontracts to submit weekly payrolls. Properly filled out, this form will satisfy the requirements of Regulations, Parts 3 and 5 (29 C.F.R., Subtitle A), as to payrolls submitted in connection with contracts subject to the Davis-Bacon and related Acts.

While completion of Form WH-347 is optional, it is mandatory for covered contractors and subcontractors performing work on Federally financed or assisted construction contracts to respond to the information collection contained in 29 C.F.R. §§ 3.3, 5.5(a). The Copeland Act (40 U.S.C. § 3145) requires contractors and subcontractors performing work on Federally financed or assisted construction contracts to "furnish weekly a statement with respect to the wages paid each employee during the preceding week." U.S. Department of Labor (DOL) Regulations at 29 C.F.R. § 5.5(a)(3)(ii) require contractors to submit weekly a copy of all payrolls to the Federal agency contracting for or financing the construction project, accompanied by a signed "Statement of Compliance" indicating that the payrolls are correct and complete and that each laborer or mechanic has been paid not less than the proper Davis-Bacon prevailing wage rate for the work performed. DOL and federal contracting agencies receiving this information review the information to determine that employees have received legally required wages and fringe benefits.

Under the Davis-Bacon and related Acts, the contractor is required to pay not less than prevailing wage, including fringe benefits, as predetermined by the Department of Labor. The contractor's obligation to pay fringe benefits may be met either by payment of the fringe benefits to bona fide benefit plans, funds or programs or by making payments to the covered workers (laborers and mechanics) as cash in lieu of fringe benefits.

This payroll provides for the contractor to show on the face of the payroll all monies to each worker, whether as basic rates or as cash in lieu of fringe benefits, and provides for the contractor's representation in the statement of compliance on the payroll (as shown on page 2) that he/she is paying for fringe benefits required by the contract and not paid as cash in lieu of fringe benefits. Detailed instructions concerning the preparation of the payroll follow:

Contractor or Subcontractor: Fill in your firm's name and check appropriate box.

Address: Fill in your firm's address.

Payroll No.: Beginning with the number "1", list the payroll number for the submission.

For Week Ending: List the workweek ending date.

Project and Location: Self-explanatory.

Project or Contract No.: Self-explanatory.

Column 1 - Name and Individual Identifying Number of Worker: Enter each worker's full name and an individual identifying number (e.g., last four digits of worker's social security number) on each weekly payroll submitted.

Column 2 - No. of Withholding Exemptions: This column is merely inserted for the employer's convenience and is not a requirement of Regulations, Part 3 and 5.

Column 3 - Work Classifications: List classification descriptive of work actually performed by each laborer or mechanic. Consult classification and minimum wage schedule set forth in contract

specifications. If additional classifications are deemed necessary, see Contracting Officer or Agency representative. An individual may be shown as having worked in more than one classification provided an accurate breakdown or hours worked in each classification is maintained and shown on the submitted payroll by use of separate entries.

Column 4 - Hours worked: List the day and date and straight time and overtime hours worked in the applicable boxes. On all contracts subject to the Contract Work Hours Standard Act, enter hours worked in excess of 40 hours a week as "overtime".

Column 5 - Total: Self-explanatory

Column 6 - Rate of Pay (Including Fringe Benefits): In the "straight time" box for each worker, list the actual hourly rate paid for straight time worked, plus cash paid in lieu of fringe benefits paid. When recording the straight time hourly rate, any cash paid in lieu of fringe benefits may be shown separately from the basic rate. For example, "\$12.25/.40" would reflect a \$12.25 base hourly rate plus \$0.40 for fringe benefits. This is of assistance in correctly computing overtime. See "Fringe Benefits" below. When overtime is worked, show the overtime hourly rate paid plus any cash in lieu of fringe benefits paid in the "overtime" box for each worker; otherwise, you may skip this box. See "Fringe Benefits" below. Payment of not less than time and one-half the basic or regular rate paid is required for overtime under the Contract Work Hours Standard Act of 1962 if the prime contract exceeds \$100,000. In addition to paying no less than the predetermined rate for the classification which an individual works, the contractor must pay amounts predetermined as fringe benefits in the wage decision made part of the contract to approved fringe benefit plans, funds or programs or shall pay as cash in lieu of fringe benefits. See "FRINGE BENEFITS" below.

Column 7 - Gross Amount Earned: Enter gross amount earned on this project. If part of a worker's weekly wage was earned on projects other than the project described on this payroll, enter in column 7 first the amount earned on the Federal or Federally assisted project and then the gross amount earned during the week on all projects, thus "\$163.00/\$420.00" would reflect the earnings of a worker who earned \$163.00 on a Federally assisted construction project during a week in which \$420.00 was earned on all work.

Column 8 - Deductions: Five columns are provided for showing deductions made. If more than five deduction are involved, use the first four columns and show the balance deductions under "Other" column; show actual total under "Total Deductions" column; and in the attachment to the payroll describe the deduction(s) contained in the "Other" column. All deductions must be in accordance with the provisions of the Copeland Act Regulations, 29 C.F.R., Part 3. If an individual worked on other jobs in addition to this project, show actual deductions from his/her weekly gross wage, and indicate that deductions are based on his gross wages.

Column 9 - Net Wages Paid for Week: Self-explanatory.

Totals - Space has been left at the bottom of the columns so that totals may be shown if the contractor so desires.

Statement Required by Regulations, Parts 3 and 5: While the "statement of compliance" need not be notarized, the statement (on page 2 of the payroll form) is subject to the penalties provided by 18 U.S.C. § 1001, namely, a fine, possible imprisonment of not more than 5 years, or both. Accordingly, the party signing this statement should have knowledge of the facts represented as true.

Items 1and 2: Space has been provided between items (1) and (2) of the statement for describing any deductions made. If all deductions made are adequately described in the "Deductions" column above, state "See Deductions column in this payroll." See "FRINGE BENEFITS" below for instructions concerning filling out paragraph 4 of the statement.

Item 4 FRINGE BENEFITS - Contractors who pay all required fringe benefits: If paying all fringe benefits to approved plans, funds, or programs in amounts not less than were determined in the applicable wage decision of the Secretary of Labor, show the basic cash hourly rate and overtime rate paid to each worker on the face of the payroll and check paragraph 4(a) of the statement on page 2 of the WH-347 payroll form to indicate the payment. Note any exceptions in section 4(c).

Contractors who pay no fringe benefits: If not paying all fringe benefits to approved plans, funds, or programs in amounts of at least those that were determined in the applicable wage decision of the Secretary of Labor, pay any remaining fringe benefit amount to each laborer and mechanic and insert in the "straight time" of the "Rate of Pay" column of the payroll an amount not less than the predetermined rate for each classification plus the amount of fringe benefits determined for each classification in the application wage decision. Inasmuch as it is not necessary to pay time and a half on cash paid in lieu of fringe benefits, the overtime rate shall be not less than the sum of the basic predetermined rate, plus the half time premium on basic or regular rate, plus the required cash in lieu of fringe benefits at the straight time rate. In addition, check paragraph 4(b) of the statement on page 2 the payroll form to indicate the payment of fringe benefits in cash directly to the workers. Note any exceptions in section 4(c).

Use of Section 4(c), Exceptions

Any contractor who is making payment to approved plans, funds, or programs in amounts less than the wage determination requires is obliged to pay the deficiency directly to the covered worker as cash in lieu of fringe benefits. Enter any exceptions to section 4(a) or 4(b) in section 4(c). Enter in the Exception column the craft, and enter in the Explanation column the hourly amount paid each worker as cash in lieu of fringe benefits and the hourly amount paid to plans, funds, or programs as fringe benefits. The contractor must pay an amount not less than the predetermined rate plus cash in lieu of fringe benefits as shown in section 4(c) to each such individual for all hours worked (unless otherwise provided by applicable wage determination) on the Federal or Federally assisted project. Enter the rate paid and amount of cash paid in lieu of fringe benefits per hour in column 6 on the payroll. See paragraph on "Contractors who pay no fringe benefits" for computation of overtime rate.

Public Burden Statement: We estimate that it will take an average of 55 minutes to complete this collection of information, including time for reviewing instructions, searching existing data sources, gathering and maintaining the data needed, and completing and reviewing the collection of information. If you have any comments regarding these estimates or any other aspect of this collection of information, including suggestions for reducing this burden, send them to the Administrator, Wage and Hour Division, ESA, U.S. Department of Labor, Room S3502, 200 Constitution Avenue, N.W., Washington, D.C. 20210.

Note: In order to view, fill out, and print PDF forms, you need Adobe® Acrobat® Reader® version 5 or later, which you may download for free at www.adobe.com/products/acrobat/readstep2.html. To save the completed forms on your workstation, you need to use the "Save As" method to save the file.

For example, move your mouse cursor over the PDF link and click on your "RIGHT" mouse button. This will cause a menu to be displayed, from which you will select the proper save option -- depending upon which browser you are using:

- For Microsoft IE users, select "Save Target As"
- For Netscape Navigator users, select "Save Link As"

Once you've selected the proper save option for your browser, and have saved the file to a location you specified, go to your program menu and start the Adobe Acrobat® Reader. Once open, locate the PDF file you saved and open it directly in Acrobat®.

- SAMPLE -

- SAMPLE -

U.S. Department of Labor
Wage and Hour Division

PAYROLL



(For Contractor's Optional Use; See Instructions at www.dol.gov/whd/forms/wh347instr.htm)

Persons are not required to respond to the collection of information unless it displays a currently valid OMB control number.

Rev. Dec. 2008

NAME OF CONTRACTOR <input type="checkbox"/> OR SUBCONTRACTOR <input checked="" type="checkbox"/>		ADDRESS 123 Main Street, Town, IL 60000		OMB No.: 1235-0008 Expires: 01/31/2015
Jones Construction Company				
PAYROLL NO. 1 - initial	FOR WEEK ENDING 04/12/2013	PROJECT AND LOCATION Non-Profit Agency New Facility Construction, Town, IL	PROJECT OR CONTRACT NO. CD13-01	

(1) NAME AND INDIVIDUAL IDENTIFYING NUMBER (e.g., LAST FOUR DIGITS OF SOCIAL SECURITY NUMBER) OF WORKER	(2) NO OF WITHHOLDING EXEMPTIONS	(3) WORK CLASSIFICATION	OT. OR ST.	(4) DAY AND DATE							(5) TOTAL HOURS	(6) RATE OF PAY	(7) GROSS AMOUNT EARNED	(8) DEDUCTIONS					(9) NET WAGES PAID FOR WEEK	
				S	M	T	W	T	F	S				FICA	WITH-HOLDING TAX	Union Dues	OTHER	TOTAL DEDUCTIONS		
				7	8	9	10	11	12	13				HOURS WORKED EACH DAY						
John Doe ###-##-1234 12 Any Street, Town, IL	2	CARPENTER JOURNEYMAN CARP0555-005	o											\$1,079.52						
			s		8.00	8.00	6.00	4.00				26.00	41.52	0.00		\$74.20	\$106.00	\$31.80		
John Doe ###-##-1234 12 Any Street, Town, IL	2	LABORER Group #1 LABO0002-003	o											\$492.80						
			s				2.00	4.00	8.00			14.00	35.20	0.00		\$34.50	\$49.28	\$13.55		
Thomas Terrific ###-##-5678 13 Any Street, Town, IL	1	CARPENTER APPRENTICE	o											\$427.00						
			s		8.00		6.00					14.00	30.50	0.00		\$29.89	\$64.05	\$12.81		
William Worker ###-##-9123 14 Any Street, Town, IL	2	LABORER Group #1 LABO0002-003	o			2.00		1.00					\$52.80	\$1,566.40						
			s		8.00	8.00	8.00	8.00	8.00			40.00	35.20	0.00		\$109.60	\$156.64	\$43.07		
James Smart ###-##-4567 15 Any Street, Town, IL	0	LABORER Group #1 LABO0002-003	o											\$2,266.00						
			s		8.00	8.00	8.00	8.00	8.00			40.00	35.20	21.45		\$158.62	\$453.20			
Samuel Jones ###-##-8912 16 Any Street, Town, IL	0	OWNER	o																	
			s		8.00	8.00						16.00								
			o																	
			s																	
			o																	
			s																	

While completion of Form WH-347 is optional, it is mandatory for covered contractors and subcontractors performing work on Federally financed or assisted construction contracts to respond to the information collection contained in 29 C.F.R. §§ 3.3, 5.5(a). The Copeland Act (40 U.S.C. § 3145) contractors and subcontractors performing work on Federally financed or assisted construction contracts to "furnish weekly a statement with respect to the wages paid each employee during the preceding week." U.S. Department of Labor (DOL) regulations at 29 C.F.R. § 5.5(a)(3)(i) require contractors to submit weekly a copy of all payrolls to the Federal agency contracting for or financing the construction project, accompanied by a signed "Statement of Compliance" indicating that the payrolls are correct and complete and that each laborer or mechanic has been paid not less than the proper Davis-Bacon prevailing wage rate for the work performed. DOL and federal contracting agencies receiving this information review the information to determine that employees have received legally required wages and fringe benefits.

Public Burden Statement

We estimate that it will take an average of 55 minutes to complete this collection, including time for reviewing instructions, searching existing data sources, gathering and maintaining the data needed, and completing and reviewing the collection of information. If you have any comments regarding these estimates or any other aspect of this collection, including suggestions for reducing this burden, send them to the Administrator, Wage and Hour Division, U.S. Department of Labor, Room S3502, 200 Constitution Avenue, N.W. Washington, D.C. 20355.

- SAMPLE -

Date 04/13/2013

I, Samuel Jones Owner / President
(Name of Signatory Party) (Title)

do hereby state:

(1) That I pay or supervise the payment of the persons employed by Jones Construction Company on the Non-Profit Agency New Facility Construction; that during the payroll period commencing on the 7 day of April, 2013, and ending the 13 day of April, 2013, all persons employed on said project have been paid the full weekly wages earned, that no rebates have been or will be made either directly or indirectly to or on behalf of said Jones Construction Company from the full (Contractor or Subcontractor)

weekly wages earned by any person and that no deductions have been made either directly or indirectly from the full wages earned by any person, other than permissible deductions as defined in Regulations, Part 3 (29 C.F.R. Subtitle A), issued by the Secretary of Labor under the Copeland Act, as amended (48 Stat. 948, 63 Stat. 108, 72 Stat. 967; 76 Stat. 357; 40 U.S.C. § 3145), and described below:

See Deductions column in this payroll

(2) That any payrolls otherwise under this contract required to be submitted for the above period are correct and complete; that the wage rates for laborers or mechanics contained therein are not less than the applicable wage rates contained in any wage determination incorporated into the contract; that the classifications set forth therein for each laborer or mechanic conform with the work he performed.

(3) That any apprentices employed in the above period are duly registered in a bona fide apprenticeship program registered with a State apprenticeship agency recognized by the Bureau of Apprenticeship and Training, United States Department of Labor, or if no such recognized agency exists in a State, are registered with the Bureau of Apprenticeship and Training, United States Department of Labor.

(4) That: (a) WHERE FRINGE BENEFITS ARE PAID TO APPROVED PLANS, FUNDS, OR PROGRAMS

[X] - in addition to the basic hourly wage rates paid to each laborer or mechanic listed in the above referenced payroll, payments of fringe benefits as listed in the contract have been or will be made to appropriate programs for the benefit of such employees, except as noted in section 4(c) below.

- SAMPLE -

- SAMPLE -

(b) WHERE FRINGE BENEFITS ARE PAID IN CASH

[] - Each laborer or mechanic listed in the above referenced payroll has been paid, as indicated on the payroll, an amount not less than the sum of the applicable basic hourly wage rate plus the amount of the required fringe benefits as listed in the contract, except as noted in section 4(c) below.

(c) EXCEPTIONS

Table with 2 columns: EXCEPTION (CRAFT) and EXPLANATION. Row 1: James Smart - Laborer, Probationary Employee, not yet qualified for pension/welfare benefits - \$56.65 hourly rate.

REMARKS:

NAME AND TITLE: Samuel Jones, Owner / President; SIGNATURE: Samuel Jones; THE WILLFUL FALSIFICATION OF ANY OF THE ABOVE STATEMENTS MAY SUBJECT THE CONTRACTOR OR SUBCONTRACTOR TO CIVIL OR CRIMINAL PROSECUTION. SEE SECTION 1001 OF TITLE 18 AND SECTION 231 OF TITLE 31 OF THE UNITED STATES CODE.

- SAMPLE -

U.S. Department of Labor
Wage and Hour Division

PAYROLL

(For Contractor's Optional Use; See Instructions at www.dol.gov/whd/forms/wh347instr.htm)



Persons are not required to respond to the collection of information unless it displays a currently valid OMB control number.

Rev. Dec. 2008

OMB No.: 1235-0008
Expires: 01/31/2015

NAME OF CONTRACTOR <input type="checkbox"/> OR SUBCONTRACTOR <input type="checkbox"/>	ADDRESS		
PAYROLL NO.	FOR WEEK ENDING	PROJECT AND LOCATION	PROJECT OR CONTRACT NO.

(1) NAME AND INDIVIDUAL IDENTIFYING NUMBER (e.g., LAST FOUR DIGITS OF SOCIAL SECURITY NUMBER) OF WORKER	(2) NO. OF WITHHOLDING EXEMPTIONS	(3) WORK CLASSIFICATION	OT. OR ST.	(4) DAY AND DATE							(5) TOTAL HOURS	(6) RATE OF PAY	(7) GROSS AMOUNT EARNED	(8) DEDUCTIONS					(9) NET WAGES PAID FOR WEEK
				HOURS WORKED EACH DAY										FICA	WITH- HOLDING TAX	OTHER	TOTAL DEDUCTIONS		
			O																
			S																
			O																
			S																
			O																
			S																
			O																
			S																
			O																
			S																
			O																
			S																

While completion of Form WH-347 is optional, it is mandatory for covered contractors and subcontractors performing work on Federally financed or assisted construction contracts to respond to the information collection contained in 29 C.F.R. §§ 3.3, 5.5(a). The Copeland Act (40 U.S.C. § 3145) contractors and subcontractors performing work on Federally financed or assisted construction contracts to "furnish weekly a statement with respect to the wages paid each employee during the preceding week." U.S. Department of Labor (DOL) regulations at 29 C.F.R. § 5.5(a)(3)(i) require contractors to submit weekly a copy of all payrolls to the Federal agency contracting for or financing the construction project, accompanied by a signed "Statement of Compliance" indicating that the payrolls are correct and complete and that each laborer or mechanic has been paid not less than the proper Davis-Bacon prevailing wage rate for the work performed. DOL and federal contracting agencies receiving this information review the information to determine that employees have received legally required wages and fringe benefits.

Public Burden Statement

We estimate that it will take an average of 55 minutes to complete this collection, including time for reviewing instructions, searching existing data sources, gathering and maintaining the data needed, and completing and reviewing the collection of information. If you have any comments regarding these estimates or any other aspect of this collection, including suggestions for reducing this burden, send them to the Administrator, Wage and Hour Division, U.S. Department of Labor, Room S3502, 200 Constitution Avenue, N.W. Washington, D.C. 20036 **Federal Requirements**

Date _____

I, _____ (Name of Signatory Party) _____ (Title)

do hereby state:

(1) That I pay or supervise the payment of the persons employed by

_____ on the _____ (Contractor or Subcontractor)

_____ (Building or Work); that during the payroll period commencing on the

_____ day of _____, _____, and ending the _____ day of _____, _____,

all persons employed on said project have been paid the full weekly wages earned, that no rebates have been or will be made either directly or indirectly to or on behalf of said

_____ from the full _____ (Contractor or Subcontractor)

weekly wages earned by any person and that no deductions have been made either directly or indirectly from the full wages earned by any person, other than permissible deductions as defined in Regulations, Part 3 (29 C.F.R. Subtitle A), issued by the Secretary of Labor under the Copeland Act, as amended (48 Stat. 948, 63 Stat. 108, 72 Stat. 967; 76 Stat. 357; 40 U.S.C. § 3145), and described below:

(2) That any payrolls otherwise under this contract required to be submitted for the above period are correct and complete; that the wage rates for laborers or mechanics contained therein are not less than the applicable wage rates contained in any wage determination incorporated into the contract; that the classifications set forth therein for each laborer or mechanic conform with the work he performed.

(3) That any apprentices employed in the above period are duly registered in a bona fide apprenticeship program registered with a State apprenticeship agency recognized by the Bureau of Apprenticeship and Training, United States Department of Labor, or if no such recognized agency exists in a State, are registered with the Bureau of Apprenticeship and Training, United States Department of Labor.

(4) That:

(a) WHERE FRINGE BENEFITS ARE PAID TO APPROVED PLANS, FUNDS, OR PROGRAMS

– in addition to the basic hourly wage rates paid to each laborer or mechanic listed in the above referenced payroll, payments of fringe benefits as listed in the contract have been or will be made to appropriate programs for the benefit of such employees, except as noted in section 4(c) below.

(b) WHERE FRINGE BENEFITS ARE PAID IN CASH

– Each laborer or mechanic listed in the above referenced payroll has been paid, as indicated on the payroll, an amount not less than the sum of the applicable basic hourly wage rate plus the amount of the required fringe benefits as listed in the contract, except as noted in section 4(c) below.

(c) EXCEPTIONS

EXCEPTION (CRAFT)	EXPLANATION

REMARKS:

NAME AND TITLE	SIGNATURE
----------------	-----------

THE WILLFUL FALSIFICATION OF ANY OF THE ABOVE STATEMENTS MAY SUBJECT THE CONTRACTOR OR SUBCONTRACTOR TO CIVIL OR CRIMINAL PROSECUTION. SEE SECTION 1001 OF TITLE 18 AND SECTION 231 OF TITLE 31 OF THE UNITED STATES CODE.

Federal Wage Decision

(will be provided to you for inclusion in the Bid Specification
Manual at the time the Manual is approved by CDC staff)

Please be advised, the included federal wage decision is being provided as a courtesy. The federal wage decisions are updated weekly and the most current versions can be obtained at www.wdol.gov

This wage decision is subject to change pending modification by the Department of Labor. The actual wages that must be paid will be “locked” at bid opening based on the most current wage decision, and provided a contract is awarded within 90 days of bid opening, and construction is started within 90 days of contract award.

OWNER COPY

CONTRACT

APPENDIX G

FEDERAL DAVIS-BACON PREVAILING WAGE RATES

OWNER COPY

CONTRACT

OWNER COPY

CONTRACT

General Decision Number: IL180011 09/07/2018 IL11

Superseded General Decision Number: IL20170011

State: Illinois

Construction Types: Heavy and Highway

Counties: Boone, De Kalb, Du Page, Kane, Kendall, Lake, McHenry and Will Counties in Illinois.

HEAVY AND HIGHWAY CONSTRUCTION PROJECTS (does not include landscape projects).

Note: Under Executive Order (EO) 13658, an hourly minimum wage of \$10.35 for calendar year 2018 applies to all contracts subject to the Davis-Bacon Act for which the contract is awarded (and any solicitation was issued) on or after January 1, 2015. If this contract is covered by the EO, the contractor must pay all workers in any classification listed on this wage determination at least \$10.35 per hour (or the applicable wage rate listed on this wage determination, if it is higher) for all hours spent performing on the contract in calendar year 2018. The EO minimum wage rate will be adjusted annually. Please note that this EO applies to the above-mentioned types of contracts entered into by the federal government that are subject to the Davis-Bacon Act itself, but it does not apply to contracts subject only to the Davis-Bacon Related Acts, including those set forth at 29 CFR 5.1(a)(2)-(60). Additional information on contractor requirements and worker protections under the EO is available at www.dol.gov/whd/govcontracts.

Modification Number	Publication Date
0	01/05/2018
1	04/06/2018
2	05/11/2018
3	05/25/2018
4	06/01/2018
5	06/08/2018
6	06/15/2018
7	06/22/2018
8	06/29/2018
9	07/06/2018
10	07/13/2018
11	08/10/2018
12	08/17/2018
13	08/24/2018
14	08/31/2018
15	09/07/2018

CARP0555-003 06/01/2018

DUPAGE ANE LAKE COUNTIES

	Rates	Fringes
CARPENTER		
Building.....	\$ 47.35	32.83
Heavy & Highway.....	\$ 47.35	32.83

CARP0555-008 06/01/2016

OWNER COPY
WILL COUNTY

	Rates	Fringes
Carpenter and Piledriver.....	\$ 45.35	32.30

CARP0555-011 06/01/2018		

KANE, McHENRY (North of Hwy 52), AND KENDALL COUNTIES

	Rates	Fringes
Carpenter and Piledriver.....	\$ 47.35	32.84

CARP0790-003 05/01/2018		

DE KALB COUNTY

	Rates	Fringes
CARPENTER.....	\$ 41.77	29.18

CARP0790-004 05/01/2018		

CARROLL, JO DAVIESS, LEE, OGLE (Oregon and South thereof),
STEPHENSON, and WHITESIDE COUNTIES

	Rates	Fringes
CARPENTER.....	\$ 41.77	29.18

CARP0792-003 05/01/2018		

BOONE COUNTY

	Rates	Fringes
CARPENTER.....	\$ 44.22	26.73

ELEC0009-002 06/03/2018		

WILL COUNTY

	Rates	Fringes
Line Construction		
Groundman.....	\$ 40.48	61.52%
Lineman and Equipment		
Operator.....	\$ 51.90	61.52%

ELEC0117-001 06/04/2018		

KANE (Northern Half) and McHENRY (All) COUNTIES

	Rates	Fringes
ELECTRICIAN.....	\$ 48.64	32.60

ELEC0150-001 07/01/2017		

LAKE COUNTY

	Rates	Fringes
--	-------	---------

OWNER COPY

CONTRACT

ELECTRICIAN.....\$ 40.00 38.49

ELEC0176-011 06/01/2018

WILL COUNTY

Rates Fringes

ELECTRICIAN.....\$ 43.50 39.26

ELEC0196-001 03/05/2018

BOONE, DEKALB, DUPAGE, KANE, KENDALL, LAKE, and MCHENRY COUNTIES

Rates Fringes

Line Construction

Equipment Operator.....\$ 42.59 32.75%+\$5.75+A
Groundman.....\$ 32.86 32.75%+\$5.75+A
Lineman, Substation
Technician, Cable Splicing
Technician, Digger
Operator, Crane Opertor 20
tons and above, and Signal
Technician.....\$ 51.06 32.75%+\$5.75+A

FOOTNOTE: A. PAID HOLIDAYS: Memorial Day, Independence
Day, Labor Day, and Thanksgiving Day

ELEC0364-003 06/01/2018

BOONE (All) & DEKALB (Remainder) COUNTIES

Rates Fringes

ELECTRICIAN.....\$ 47.00 33.51

ELEC0461-006 06/04/2018

DEKALB (Sandwich TWP), KANE (Southern Half) & KENDALL (All)
COUNTIES

Rates Fringes

ELECTRICIAN.....\$ 47.72 32.39

ELEC0701-001 06/04/2018

DUPAGE COUNTY

Rates Fringes

ELECTRICIAN.....\$ 40.50 102.09%

ENGI0150-015 06/01/2018

BOONE and DE KALB COUNTIES

Rates Fringes

OPERATOR: Power Equipment

Group 1.....\$ 46.65 37.45
Group 2.....\$ 46.10 37.45

Group 3.....	\$ 44.80	37.45
Group 4.....	\$ 43.35	37.45
Group 5.....	\$ 41.90	37.45

POWER EQUIPMENT OPERATOR CLASSIFICATIONS

GROUP 1: Asphalt Plant; Asphalt Heater and Planer combination; Asphalt Spreader; Asphalt Silo Tender; Autograder, GOMACO or similar; Belt Loader; Caisson Rigs; Car Dumper, Central Redi-Mix Plant; Combination Backhoe Front End Loader Machine (1 cu yd or over Backhoe bucket with attachments); Backhoe with Shear attachment; Concrete Breaker (truck mounted); Concrete Conveyor; Concrete Paver over 27E cu ft; Concrete Placer; Concrete Tube Float; Cranes, all attachments; Cranes, Hammerhead, Linden, Peco and machines of a like nature; Creter Crane; Crusher, stone; Derricks; Derrick Boats; Derricks, traveling; Dredges; Field Mechanical Welder; Formless Curb and Gutter Machine; Gradall and machines of a like nature; Grader, Elevating; Grader, Motor Grader, Motor Patrol, Auto Patrol, Form Grader, Pull Grader, Subgrader; Guard Rail Post Driver mounted; Hoists, one, two, and three Drum; Hydraulic Backhoes; Locomotive, all Mucking Machine; Pile Drivers and Skid Rig; Pre-Stress Machine; Pump Cretes Dual Ram; Rock Drill-Crawler or Skid Rig; Rock Drill truck mounted; Roto Mill Grinder, 36" and over; Roto Mill Grinder, less than 36"; Slip- Form Paver; Soil Test Drill Rig, truck mounted; Straddle Buggies; GCI Crane and similar; Hydraulic Telescoping Form (tunnel); Tie Back Machine; Tractor Drawn Belt Loader: Tractor Drawn Belt Loader with attached Pusher; Tractor with boom; Tractaire with attachment; Traffic Barrier Conveyor Machine; Raised or Blind Hoe Drill (Tunnel & Shaft); Trenching Machine; Truck Mounted Concrete Pump with boom; Truck mounted Concrete Conveyor; Underground Boring and/or Mining Machines under 5 ft; Wheel Excavator & Widener (Apsco)

GROUP 2: Batch Plant; Bituminous Mixer; Bobcats over .75 cu yd; Boiler and Throttle Valve; Bulldozer; Car Loader Trailing Conveyors; Combination Backhoe Front End Loader Machine, less than 1 cu yd Backhoe Bucket with attachments; Compressor and Throttle Valve; Compressor, common receiver (3); Concrete Breaker or Hydro Hammer; Concrete Grinding Machine; Concrete Mixer or Paver 7S series to and including 27 cu ft; Concrete Spreader; Concrete Curing Machine, Burlap Machine; Belting Machine and Sealing Machine; Conveyor Muck Cars (Haglund or similar type); Finishing Machine-Concrete; Greaser Engineer; Highlift Shovels or Front End Loader; Hoist-Sewer Dragging Machine; Hydraulic Boom Trucks, all attachments; Locomotives, Dinky; Pump Cretes, Squeeze Cretes-Screw Type pumps, Gypsum Bulker and Pump; Roller Asphalt; Rotary Snow Plows; Rototiller, Seaman, etc self-Propelled; Scoops-Tractor Drawn; Self-propelled Compactor; Spreader-Chip- Stone etc; Scraper; Scraper-Prime Mover in Tandem regardless of size (add \$1.00 to to Group 2 hourly rate for each hour and for each machine attached thereto); Tank Car Heater; Tractors, Push, pulling Sheeps Foot, Disc, or Compactor, etc; Tug Boats

GROUP 3: Boilers; Brooms, all power propelled; Cement Supply Tender; Compressor, Common Receiver (2); Concrete Mixer, two bag and over; Conveyor, Portable; Farm type Tractors used for mowing, seeding, etc; Fireman on Boilers; Forklift Trucks; Grouting Machines; Hoists, Automatic; Hoists, all

OWNER COPY

Elevators; Hoists, Tugger single Drum; Jeep Diggers; Pipe Jacking Machines; Post- hole Digger; Power Saw, Concrete, Power Driven; Pug Mills; Rollers, other than asphalt; Seed and Straw Blower; Steam Generators; Stump Machine; Winch Trucks with A-Frame; Work Boats; Tamper-Form motor driven

GROUP 4: Air compressor - Small 185 and under (1 to 5 not to exceed a total of 300 ft); Air Compressor - Large over 185; Asphalt Spreader Backend Man; Combination - Small Equipment Operator; Generators - Small 50 kw and under; Generators - Large , over 50 kw; Heaters, Mechanical; Hydraulic power unit (Pile Driving, Extracting or Drilling); Light Plants All (1 to 5); Pumps, over 3" (1 to 3, not to exceed a total of 300 ft); Pumps, Well Points; Tractaire; Welding Machines (2 through 5); Winches, 4 small electric drill winches; Bobcats up to and including .75 cu yd

GROUP 5: Oilers

PREMIUM PAY:

Long Boom :

Cranes & Derricks 90' to 150' including jib receive an extra \$.50 per hour. Cranes & Derricks over 150' including jib receive an extra \$.50 per hour plus an additional \$.10 for each additional 10' of boom or jib.

Capacity Pay: Cranes & Derricks with maximum capacity exceeding 50 ton with less than 90' of boom or jib shall be compensated \$.01 per hour for each ton of the rated capacity in excess of 50 ton.

Long Boom pay and Capacity pay cannot be combined.

Crane mounted earth auger, raised and blind hole drills, and truck mounted drill rigs receive an extra \$.50 per hour.

Creter Cranes:

When the Creter Crane is equipped with a conveyor system capable of extending 70' or more, the engineer shall receive an extra \$.50 per hour.

Truck Mounted Concrete Pumps:

When the Truck Mounted Concrete Pump is equipped with a boom, which is capable of extending 90' or more, the engineer shall receive \$.50 per hour extra.

Truck Mounted Concrete Conveyor:

Truck Mounted Concrete Conveyors equipped with conveyors that are capable of extending 90' or more, the engineer shall receive an extra \$.50 per hour.

Underground Work:

Employees working in tunnels, shafts, etc. shall be paid an additional \$.40 per hour. Employees working under air pressure 1/2 pound to 7 pounds shall receive an additional \$.50 per hour. Employees working under air pressure of 7 pounds or over shall receive \$.65 per hour more.

Mining Machines- Boring Machines:

The crew operating and maintaining the Mining Machines shall be compensated an additional \$.50 per hour.

* ENGI0150-024 06/01/2018

DUPAGE, KANE, KENDALL, LAKE, McHENRY, and WILL COUNTIES

Rates Fringes

OPERATOR: Power Equipment

GROUP 1.....	\$ 49.30	38.15
GROUP 2.....	\$ 48.75	38.15
GROUP 3.....	\$ 46.70	38.15
GROUP 4.....	\$ 45.30	38.15
GROUP 5.....	\$ 44.10	38.15

POWER EQUIPMENT OPERATOR CLASSIFICATIONS

GROUP 1: Asphalt Plant*; Asphalt Heater and Planer combination; Asphalt Heater Scarfire*, Asphalt Spreader; Autograder/ GOMACO or similar; ABG Paver*, Backhoes with Caisson attachment*, Ballast Regulator, Belt Loader*; Caisson Rigs*Car Dumper, Central Redi-Mix Plant*, Combination Backhoe; Front End Loader Machine (1 cu yd or over Backhoe bucket or with attachments); Concrete Breaker (truck mounted); Concrete Conveyor; Concrete Paver over 27E cu ft*; Concrete Placer*; Concrete Tube Float; Cranes, all attachments*; Cranes, Hammerhead, Linden, Peco and machines of a like nature*; Creter Crane; Crusher, stone; All Derricks; Derrick Boats; Derricks, traveling*; Dowell Machine with Air Compressor (\$1.00 above Class 1); Dredges*; Field Mechanic Welder; Formless Curb and Gutter Machine*; Gradall and machines of a like nature*; Grader, Elevating; Grader, Motor Grader, Motor Patrol, Auto Patrol, Form Grader, Pull Grader, Subgrader; Guard Rail Post Driver mounted*; Hoists, one, two, and three Drum; Hydraulic Backhoes*; Backhoes with Shear attachments*; Mucking Machine; Pile Drivers and Skid Rig*; Pre-Stress Machine; Pump Cretes Dual Ram (requires frequent lubrication and water)*; Rock Drill- Crawler or Skid Rig*; Rock Drill truck mounted*; Rock/ Track Tamper; Roto Mill Grinder, (36" and over)*; Slip-Form Paver*; Soil Test Drill Rig, truck mounted*; Straddle Buggies; Hydraulic Telescoping Form (tunnel); Tractor Drawn Belt Loader*; Tractor Drawn Belt Loader with attached Pusher (two engineers); Tractor with boom; Tractaire with attachment; Traffic Barrier Transfer Machine*; Trenching Machine; Truck Mounted Concrete Pump with boom*; Underground Boring and/or Mining Machines 5 ft in diameter and over tunnel, etc.*; Wheel Excavator* & Widener (Apsco); Raised or Blind Hoe Drill, Tunnel & Shaft*

GROUP 2: Batch Plant*; Bituminous Mixer; Boiler and Throttle Valve; Bulldozer; Car Loader Trailing Conveyors; Combination Backhoe Front End Loader Machine, (less than 1 cu yd Backhoe Bucket with attachments); Compressor and Throttle Valve; Compressor, common receiver (3); Concrete Breaker or Hydro Hammer; Concrete Grinding Machine; Concrete Mixer or Paver 7S series to and including 27 cu ft; Concrete Spreader; Concrete Curing Machine; Burlap Machine; Belting Machine and Sealing Machine; Concrete Wheel Saw; Conveyor Muck Cars (Haglund or similar type); Drills (all); Finishing Machine-Concrete; Greaser Engineer; Highlift Shovels or Front End Loader; Hoist- Sewer Dragging Machine; Hydraulic Boom Trucks, all attachments; Hydro-Blaster (requires two operators); Laser Screed*; Locomotives, Dinky; Off-Road Hauling Units (including articulating); Pump Cretes; Squeeze Cretes-Screw Type pumps, Gypsum Bulker and Pump; Roller Asphalt; Rotary Snow Plows; Rototiller, Seaman, self-Propelled; Scoops-Tractor

OWNER COPY

CONTRACT

Drawn; Self- propelled Compactor; Spreader-Chip-Stone; Scraper; Scraper-Prime Mover in Tandem regardless of size (add \$1.00 to Group 2 hourly rate for each hour and for each machine attached thereto add \$1.00 to Group 2 hourly rate for each hour); Tank Car Heater; Tractors, Push, pulling Sheeps Foot, Disc, or Compactor, etc; Tug Boats

GROUP 3: Boilers; Brooms, all power propelled; Cement Supply Tender; Compressor, Common Receiver (2); Concrete Mixer, two bag and over; Conveyor, Portable; Farm type Tractors used for mowing, seeding, etc; Fireman on Boilers; Forklift Trucks; Grouting Machines; Hoists, Automatic; Hoists, all Elevators; Hoists, Tugger single Drum; Jeep Diggers; Low Boys; Pipe Jacking Machines; Post-hole Digger; Power Saw, Concrete, Power Driven; Pug Mills; Rollers, other than asphalt; Seed and Straw Blower; Steam Generators; Stump Machine; Winch Trucks with A-Frame; Work Boats; Tamper-Form motor driven

GROUP 4: Air compressor - Small 250 and under (1 to 5 not to exceed a total of 300 ft); Air Compressor - Large over 250; Combination - Small Equipment Operator; Directional Boring Machine; Generators - Small 50 kw and under; Generators - Large , over 50 kw; Heaters, Mechanical; Hydraulic power unit (Pile Driving, Extracting or Drilling); Light Plants (1 to 5); Pumps, over 3" (1 to 3, not to exceed a total of 300 ft); Pumps, Well Points; Tractaire; Welding Machines (2 through 5); Winches, 4 small electric drill winches;

GROUP 5: Bobcats (All); Brick Forklifts; Oilers; Directional Boring

*Requires Oiler

IRON0001-014 06/01/2018

DU PAGE (Eastern 1/4), LAKE, AND MCHENRY (Hebron, Woodstock, and East thereof) COUNTIES

	Rates	Fringes
IRONWORKER		
Sheeter.....	\$ 49.08	38.28
Structural and Reinforcing..	\$ 48.83	38.28

* IRON0063-003 06/01/2018

LAKE, DUPAGE (Eastern 1/4) and MCHENRY (HEBRON, WOODSTOCK & EAST THEREOF) COUNTIES

	Rates	Fringes
IRONWORKER, ORNAMENTAL.....	\$ 48.05	35.93

IRON0393-003 06/01/2018

DEKALB (SOUTHEASTERN 2/3 including Sycamore and Dekalb), DUPAGE (REMAINDER), KANE, KENDALL (NORTHERN PART), and MCHENRY (SOUTHEAST 1/4) COUNTIES

Rates Fringes

OWNER COPY

CONTRACT

IRONWORKER.....	\$ 45.84	35.50
-----------------	----------	-------

IRON0444-006 06/01/2018

KENDALL (Southern Part) and WILL COUNTIES

	Rates	Fringes
--	-------	---------

IRONWORKER.....	\$ 43.00	38.20
-----------------	----------	-------

IRON0498-003 06/01/2018

BOONE, DEKALB (EXCEPT Southeast), and MCHENRY (Northwest) COUNTIES

	Rates	Fringes
--	-------	---------

IRONWORKER.....	\$ 39.39	38.89
-----------------	----------	-------

LAB00002-004 06/01/2017

DUPAGE COUNTY

	Rates	Fringes
--	-------	---------

LABORER (SEWER CONSTRUCTION)

GROUP 1.....	\$ 41.20	27.47
GROUP 2.....	\$ 41.33	27.47
GROUP 3.....	\$ 41.43	27.47
GROUP 4.....	\$ 41.55	27.47
GROUP 5.....	\$ 41.20	27.47

LABORER CLASSIFICATIONS

GROUP 1: Signalmen Top Laborers, and all other Laborers not Mentioned.

GROUP 2: Concrete Laborers; Steel Setters.

GROUP 3: Cement Carriers; Cement Mixers; Concrete Repairmen; Mortar Men; Scaffold Men; and Second Bottom Men.

GROUP 4: Bottom Men; Bracers-Bracing; Bricklayer's Tender; Catch Basin Digger; Drainlayer; Dynamiter; Form Men; Jackhammermen; Powerpac; Pipelayers; Rodders; Welders & Burners; Well Point System Men.

GROUP 5: Asbestos Abatement Laborers, Toxic and Hazardous Waste Removal Laborers & Dosimeter use (any device) Monitoring Nuclear Exposure.

LAB00002-009 06/01/2017

DU PAGE COUNTY

	Rates	Fringes
--	-------	---------

LABORER (Compressed Air)

0 - 15 lbs.....	\$ 42.20	27.47
16 - 20 lbs.....	\$ 42.70	27.47
21 - 26 lbs.....	\$ 43.20	27.47
27 - 33 lbs.....	\$ 44.20	27.47

OWNER COPY

CONTRACT

34 lbs and over.....	\$ 45.20	27.47
LABORER (Tunnel and Sewer)		
GROUP 1.....	\$ 41.20	27.47
GROUP 2.....	\$ 41.33	27.47
GROUP 3.....	\$ 41.43	27.47
GROUP 4.....	\$ 41.55	27.47
GROUP 5.....	\$ 41.20	27.47

LABORER CLASSIFICATIONS (TUNNEL)

GROUP 1: Cage tenders; Dumpmen; Flagmen; Signalmen; Top laborers

GROUP 2: Air hoist operator; Key board operator; concrete laborer; Grout; Lock tenders (Free Air Side); Steel setters; Tuggers; Switchmen; Car pusher

GROUP 3: Concrete repairmen; Lock tenders (pressure side); Mortar men; Muckers; Grout machine operators; Track layers

GROUP 4: Air trac drill operator; Miner; Bricklayer tenders; Concrete blower operator; Drillers; Dynamiters; Erector operator; Form men; Jackhammermen; Powerpac; Mining machine operators; Mucking machine operator; Laser beam operator; Liner plate and ring setters; Shield drivers; Power knife operator; Welder- burners; Pipe jacking machine operator; skimmers; Maintenance technician

GROUP 5: Asbestos abatement laborer; Toxic and hazardous waste removal laborer; Dosimeter (any device) monitoring nuclear exposure

LABORER CLASSIFICATIONS (SEWER)

GROUP 1: Signalmen; Top laborers and All other laborers

GROUP 2: Concrete laborers and Steel setters

GROUP 3: Cement carriers; Cement mixers; Concrete repairmen; Mortar men; Scaffold men; Second Bottom men

GROUP 4: Air trac drill operator; Bottom men; Bracers-bracing; Bricklayer tenders; Catch basin diggers; Drainlayers; dynamiters; Form men; Jackhammermen; Powerpac; Pipelayers; Rodders; Welder-burners; Well point systems men

GROUP 5: Asbestos abatement laborer, Toxic and hazardous waste removal laborer; Dosimeter (any device) monitoring nuclear exposure

LAB00032-007 05/01/2018

DE KALB COUNTY

	Rates	Fringes
LABORER		
General Laborer.....	\$ 35.40	31.73
Skilled Laborer.....	\$ 38.25	31.73

LABORER CLASSIFICATIONS

General Laborer: Carpenter Tender, Tool Cribman, Fireman or Salamander Tender, Flagman, Gravel Box Man, Bumpman &

OWNER COPY

CONTRACT

Spotter, Form Handler, Material Handler, Fencing Laborer, Cleaning Lumber, Pit Man, Material Checker, Landscaper, Unloading Explosives, Laying of Sod, Planting of Trees, Asphalt Workers With Machine & Layers, Asphalt Plant Laborer, Wrecking, Fire-proofing, Driving Stakes, Stringlines for All Machinery, Window Cleaning, Demolition Worker, Explosive Handling, Trimming & Removal of Trees, Multi-Plate Pipe, Pilot Cars for Traffic Control, Power Rigging

Skilled Laborer: Asbestos Abatement Worker; Hazardous Waste Worker Handling any Materials with any Foreign Matter Harmful to Skin or Clothing, Track Labor, Cement Handler, Chloride Handler, Unloading & Laborers with Steel Workers & Re-bars, Wet Concrete Workers, Tunnel Tenders in Free Air, Batch Dumper, Mason Tender, Kettle & Tar Man, Tank Cleaner, Plastic Installer, Scaffold Worker, Motorized Buggies or Motorized Unit Used For Wet Concrete or Handling of Building Materials, Laborers With De-Watering Systems, Sewer Workers Plus Depth, Vibrator Operator; Cement Silica, Clay, Fly Ash, Lime & Plasters Handlers (Bulk or Bag); Cofferdam Worker Plus Depth, Concrete Paving, Placing, Cutting & Tying of Reinforcing, Deck Hand, Dredge Hand and Shore Laborer, Bankman on Floating Plant, Grade Checker, Power Tools, Front End Man on Chip Spreader, Caisson Worker Plus Depth, Gunnite Nozzleman, Leadman on Sewer Work, Welder, Cutter, Burner & Torchman, Chain Saw Operator, Jackhammer & Drill Operator, Layout Man and/or Tile Layer, Steel Form Setter - Street & Highway, Air Tamping Hammerman, Signal Man On Crane, Concrete Saw Operator, Screenman on Asphalt Paver, Tending Masons with Hot Material or Where Foreign Materials are used, Mortar Mixer Operator, Multiple Concrete Duct - Leadman, Luteman, Asphalt Raker Curb Asphalt Machine Operator, Ready Mix Scaleman Permanent Portable or Temporart Plant, Laborer Handling Masterplate or Similar Materials, Laser Beam Operator, Concrete Burning Machine Operator, Coring Machine Operator, Plaster Tender, Underpinning & Shoring of Buildings, Pump Man, Manhole & Catch Basin, Dirt & Stone Tamper, Hoseman on Concrete Pump.

LABO0075-002 06/01/2017

WILL COUNTY

	Rates	Fringes
LABORER		
GROUP 1.....	\$ 41.20	27.47
GROUP 2.....	\$ 41.55	27.47
GROUP 3.....	\$ 41.20	27.47
GROUP 4.....	\$ 41.55	27.47
GROUP 5.....	\$ 41.40	27.47
GROUP 6.....	\$ 41.55	27.47
GROUP 7.....	\$ 41.40	27.47

LABORER CLASSIFICATIONS

GROUP 1 - Mortar mixers, handling asphalt shingles; Scaffolds; Sewer and trench work (ground level down to 8 feet); Catch basin and manhole diggers, mesh handling on road work; Cement and mineral filler handler; Concrete puddlers; Batch dumpers (cement & asphalt); Vibrator operators; Sand and stone wheelers to mixer Handlers);

OWNER COPY

Concrete wheelers; Airtamping hammermen; Concrete & paving breakers; Rock drillers/Jackhammermen; Chipping hammermen 1-Bag mixer; Asphalt laborer; Chain and power saws; Pit men; Fencing laborers; Mason tenders (mortar and brick wheeler); Kettlemen & tarmen, tank cleaners; Scaffold and staging laborers; Pot Firemen (tarmen); Heaters tender for any purpose; Water pumps (portable water pumps shall be tended by laborers if the employer determines tending is required); Rip rap; Handling of slab steel road forms in any manner, except road form setting, setting center strips, Contraction and expansion joints (road work); Unloading and handling of lumber, brick, transite materials, cast iron water pipe, reinforced concrete rods, sewer and drain tile, railroad tiles and all other creosoted materials; paving blocks and concrete forms; Handling of insulation of any type; all work involving the unloading of materials, fixtures, or furnishing, whether crated or uncrated; all mortar and composition mixers of sewer work; track laborers; Chimney and silo laborers working at a height of 1 to 48 feet; All laborers working on swinging suspended, or any type or make of scaffolding 1 to 48 feet; All laborers working inside a sphere or any type or make of tank; Working inside a sphere or any type or make of tank from bottom to a height of 48 feet; Form strippers (any type); Mechanical or motorized buggies, for concrete or masons employers; Use of skid steer loads or any other machinery which replaces the wheelbarrow or buggy; Handling multiple concrete duct or any other type of pipe used in public utility work unless otherwise specified herein; Snapping of wall ties and removal of rods; drilling of anchor bolt holes; Concrete or asphalt clipper type saws and self-propelled saws; Shoulder and grade laborers; All hydraulic electric and air or any other type of tools; Grouting and caulking; Cleaning lumber, Nail pulling, Deck hand; Dredgehand; Shore laborer; Bankmen on Floating Plant; Tool and material checkers; Signalmen and Flagmen on all construction work; Cleaning of debris; Removal of trees; Concrete curing, temporary concrete protection regardless of manner or materials used; Laborers on Apsco; Janitorial; Wrecking and demolition laborers

GROUP 2 - Sewer and drain pipe layers and multiple concrete duct or any other type of pipe used, on public utility work (ground level to 8 feet); Pumpcrete pipe handlers

GROUP 3 - Asphalt rakers; Hod carriers; Plasterer laborers; Gunnite laborers, Slab for setters on roads, highways, streets, airport runaways, and radii (any type of form) stringline men for all aforementioned work; Wagon and tower drillers on land and floating plant used on dredging; Asphalt gunners and plug men (undercoating on road work); Mortar pump laborers; Plaster pump laborers

GROUP 4 - Tunnel miners, and all laborers inside tunnel; Air blow pipemen; Torchmen (burners); Mortaring men on sewer and drain pipe (the applying of mortar and composition mixes); All bottom men on sewer work-all sewer and drain pipelayers-multiple concrete duct or any other type of pipe used on public utility work-8 feet or more below ground level, and all other sewer and trench laborers 8 feet or more below ground level regardless of excavation area; All labor work inside cofferdam; Use of a 10 foot or more drill steel for hand held drills; Caisson laborers ground level down 15 feet; All air tools 8 feet or more below ground level; All laborers working on swinging-suspended or any

type or make of scaffolds, 48 feet to 100 feet; All chimney and silo laborers working at a height of 48 to 100 feet; All tamping hammers over 150 lbs.; All laborers working inside of a sphere or any type or make of tank at a height of 48 feet to 100 feet; all hydraulic, electric and air tools or any other type 8 feet or more below ground level; Vibrators-any type-8 feet or more below ground level

GROUP 5 - Gunnite nozzle men; Caisson laborers and all tamping hammers from 150 lbs and over; from 15 feet below ground level down to 50 feet; and all laborers working inside of a sphere or any type of tank for every additional 50 feet or part thereof above 100 feet in height

GROUP 6 - All underground cavern laborers; Caisson laborers 50 feet or more below ground level; Laborers working under radio active conditions (suiting up); Blasting men (Powdermen)

GROUP 7 - Dosimeter (any device) used for monitoring nuclear exposure; Asbestos abatement worker; Toxic and hazardous waste removal laborer; and chimney and silo laborers for every additional 50 feet or any part thereof above 100 feet high

LAB00149-002 06/01/2017

BOONE, KANE, KENDALL, AND MCHENRY COUNTIES

	Rates	Fringes
LABORER		
GROUP 1.....	\$ 41.20	27.47
GROUP 2.....	\$ 41.43	27.47
GROUP 3.....	\$ 41.20	27.47
GROUP 4.....	\$ 41.20	27.47
GROUP 5.....	\$ 41.43	27.47
GROUP 6.....	\$ 41.55	27.47
GROUP 7.....	\$ 41.55	27.47
GROUP 8.....	\$ 41.20	27.47
GROUP 9.....	\$ 41.40	27.47

LABORER CLASSIFICATIONS

GROUP 1: Common laborer, Asphalt laborer, Asphalt plant laborer, Striping laborer, Clipper type concrete saw, Self-propelled saws

GROUP 2: Air tampers & Vibrators

GROUP 3: Mortar & Concrete mixers

GROUP 4: Stringline & form setter; Torchman (demolition), Sheeting & Cribbing, Black top rakers & lutemen, Machine screwmen

GROUP 5: Chain saw man, Jackhammer man, Drillman, Concrete breaders & air spade,

GROUP 6: Tunnel laborers, Tile layers & bottom men

GROUP 7: Caisson diggers, Dynamiters

GROUP 8: Flagman

OWNER COPY

CONTRACT

GROUP 9: Asbestos abatement laborers, Toxic & hazardous waste removal laborers & Dosimeter (any device) monitoring nuclear exposure

LAB00152-003 06/01/2017

LAKE COUNTY

	Rates	Fringes
LABORER		
GROUP 1.....	\$ 41.20	27.47
GROUP 2.....	\$ 41.28	27.47
GROUP 3.....	\$ 41.20	27.47
GROUP 4.....	\$ 41.43	27.47
GROUP 5.....	\$ 41.40	27.47
GROUP 6.....	\$ 41.40	27.47

LABORER CLASSIFICATIONS

GROUP 1: General laborers; Asphalt

GROUP 2: Cement gun laborers

GROUP 3: Asphalt Tampers and Smoothers

GROUP 4: Rakers and Lutemen; Machine screwman; Kettlemen; Mixer-men, Drum-Men; Jackhammermen (Asphalt); Mite Box Spreaders; Laborers on birch overman and similar spreader equipment; Laborers on apSCO; Laborers on Air Compressors; Paving Form Setters; Jackhammerman (Concrete); Power Drive Concrete Saws

GROUP 5: Cement Gun Nozzle (Gunitite)

GROUP 6: Asbestos abatement laborers; Toxic and hazardous waste removal laborers; Dosimeter (any device monitoring nuclear exposure)

PAIN0014-003 06/01/2018

LAKE and WILL COUNTIES

	Rates	Fringes
PAINTER: Brush Only.....	\$ 46.55	27.24

PAIN0030-001 07/01/2018

DE KALB, DU PAGE, KANE, KENDALL AND MCHENRY COUNTIES

	Rates	Fringes
PAINTER		
Brush, Drywall		
Taper/Finisher,		
Sandblaster, and Spray.....	\$ 46.55	21.58

PAIN0030-004 07/01/2018

BOONE, JO DAVIESS, LEE, OGLE, STEPHENSON AND WINNEBAGO COUNTIES

Rates Fringes

OWNER COPY

CONTRACT

PAINTER

Brush, Roller, Spray, Sandblasting, Paperhanger, Drywall Finishing, Taper, and Spray Structural Steel...	\$ 39.95	22.61
---	----------	-------

PLAS0011-002 06/01/2017

WILL COUNTY

	Rates	Fringes
CEMENT MASON/CONCRETE FINISHER...	\$ 42.00	34.56

PLAS0011-008 06/01/2017

DE KALB, KANE, KENDALL, AND MCHENRY COUNTIES

	Rates	Fringes
CEMENT MASON/CONCRETE FINISHER...	\$ 44.84	31.60

PLAS0011-013 06/01/2017

LAKE COUNTY

	Rates	Fringes
CEMENT MASON/CONCRETE FINISHER...	\$ 44.98	31.47

PLAS0011-015 06/01/2017

BOONE COUNTY

	Rates	Fringes
CEMENT MASON/CONCRETE FINISHER...	\$ 36.99	26.93
PLASTERER.....	\$ 34.78	27.28

PLAS0803-001 08/01/2010

DUPAGE COUNTY

	Rates	Fringes
CEMENT MASON/CONCRETE FINISHER...	\$ 38.00	24.03

* TEAM0179-002 06/01/2017

KENDALL and WILL COUNTIES

	Rates	Fringes
TRUCK DRIVER		
2 or 3 Axle Trucks.....	\$ 37.68	0.15+a
4 Axle Trucks.....	\$ 37.83	0.15+a
5 Axle Trucks.....	\$ 38.03	0.15+a
6 Axle Trucks.....	\$ 38.23	0.15+a

FOOTNOTES:

- a. \$733.20 per week.
- b. Lowboy rate based on number of axles

An additional \$.20 per axle shall be paid for all vehicles

OWNER COPY

with more than six (6) axles.

CLASSIFICATIONS:

Group 1 - Frame Truck when used for transportation purposes; Air Compressor and Welding Machines, including those pulled by cars, pick-up trucks and tractors; Ambulances; Articulated Dumps; Batch Gate Lockers; Batch Hopperman; Car and Truck Washers; Carry Alls; Forl Lifts and Hoisters; Helpers; Mechanics Helpers and Greasers; Oil Distributors, two-man operation; Pavement Breakers; Pole Trailer, up to 40 feet; Pothole Repair Trucks; Power Mower Tractors; Quick Change Barrier; Self-Propelled Chip Spreader; Shipping and Receiving Clerks and Checkers; Skipman; Slurry Trucks, two-man operation; Slurry Trucks, Conveyor Operated - 2 or 3 man operation; Teamsters; Unskilled Dumpmen; Warehousemen and Dockmen; Truck Drivers hauling warning lights, barricades, and portable toilets on the job site

Group 2 - Dispatcher; Dump Crets and Adgetators under 7 yards; Dumpsters, Track Trucks, Euclids, Hug Bottom Dump Turnapulls or Turnatrailers when pulling other than self-loading equipment or similar equipment under 16 cubic yards; Mixer Trucks under 7 yards; Ready-Mix Plant Hopper Operator; Winch Trucks, 2 Axles

Group 3 - Dump Crets and Adgetators, 7 yards and over; Dumpsters, Track Trucks, Euclids, Hug Bottom Dump Turnapulls or Turnatrailers when pulling other than self-loading equipment or similar equipment over 16 cubic yards; Explosives and/or Fission Material Trucks; Mixer Trucks 7 yards or over; Mobile Cranes while in transit; Oil Distributors, one-man operation; Pole Trailer, over 40 feet; Pole and Expandable Trailers hauling material over 50 feet long; Slurry Trucks, one-man operation; Winch Trucks, 3 axles or more; Mechanic - *Truck Welder and *Truck Painter*These classifications shall only apply in areas where and when it has been a past area practice; Asphalt Plant Operators in areas where it has been past practice

Group 4 - Dual-purpose vehicels, such as mounted crane tucks with hoist and accessories; Foreman; Master Mechanic; Self-loading equipment like P.B. and trucks with scoops on the front

* TEAM0301-001 06/01/2017

LAKE AND MCHENRY COUNTIES

	Rates	Fringes
TRUCK DRIVER		
2-3 AXLES.....	\$ 37.69	10.15+a
4 AXLES.....	\$ 37.84	10.15+a
5 AXLES.....	\$ 38.04	10.15+a
6 AXLES.....	\$ 38.24	10.15+a

FOOTNOTES:

- a. 325.20 per week.
- b. Lowboy rate based on number of axles

An additional \$.20 per axle shall be paid for all vehicles with more than six (6) axles.

Paid Holidays: New Year's Day, Memorial Day, Independence Day, Labor Day, Thanksgiving Day, and Christmas Day.

900 straight time hours or more in 1 calendar year for the same employer shall receive 1 week paid vacation; 3 years - 2 weeks paid vacation; 10 years - 3 weeks paid vacation; 20 years - 4 weeks paid vacation.

CLASSIFICATIONS:

Group 1 - Frame Truck when used for transportation purposes; Air Compressor and Welding Machines, including those pulled by cars, pick-up trucks and tractors; Ambulances; Articulated Dumps; Batch Gate Lockers; Batch Hopperman; Car and Truck Washers; Carry Alls; Forl Lifts and Hoisters; Helpers; Mechanics Helpers and Greasers; Oil Distributors, two-man operation; Pavement Breakers; Pole Trailer, up to 40 feet; Pothole Repair Trucks; Power Mower Tractors; Quick Change Barrier; Self-Propelled Chip Spreader; Shipping and Receiving Clerks and Checkers; Skipman; Slurry Trucks, two-man operation; Slurry Trucks, Conveyor Operated - 2 or 3 man operation; Teamsters; Unskilled Dumpmen; Warehousemen and Dockmen; Truck Drivers hauling warning lights, barricades, and portable toilets on the job site

Group 2 - Dispatcher; Dump Crets and Adgetators under 7 yards; Dumpsters, Track Trucks, Euclids, Hug Bottom Dump Turnapulls or Turnatrailers when pulling other than self-loading equipment or similar equipment under 16 cubic yards; Mixer Trucks under 7 yards; Ready-Mix Plant Hopper Operator; Winch Trucks, 2 Axles

Group 3 - Dump Crets and Adgetators, 7 yards and over; Dumpsters, Track Trucks, Euclids, Hug Bottom Dump Turnapulls or Turnatrailers when pulling other than self-loading equipment or similar equipment over 16 cubic yards; Explosives and/or Fission Material Trucks; Mixer Trucks 7 yards or over; Mobile Cranes while in transit; Oil Distributors, one-man operation; Pole Trailer, over 40 feet; Pole and Expandable Trailers hauling material over 50 feet long; Slurry Trucks, one-man operation; Winch Trucks, 3 axles or more; Mechanic - *Truck Welder and *Truck Painter*These classifications shall only apply in areas where and when it has been a past area practice; Asphalt Plant Operators in areas where it has been past practice

Group 4 - Dual-purpose vehicels, such as mounted crane tucks with hoist and accessories; Foreman; Master Mechanic; Self-loading equipment like P.B. and trucks with scoops on the front

* TEAM0325-004 06/01/2017

BOONE and WINNEBAGO COUNTIES

	Rates	Fringes
TRUCK DRIVER		
2 - 3 Axles.....	\$ 36.62	20.40
4 Axles.....	\$ 36.77	20.40
5 Axles.....	\$ 36.97	20.40
6 Axles.....	\$ 37.08	20.40

FOOTNOTE: An additional \$.20 per axle shall be paid for all vehicles with more than six (6) axles.

CLASSIFICATIONS:

Group 1 - Frame Truck when used for transportation purposes; Air Compressor and Welding Machines, including those pulled by cars, pick-up trucks and tractors; Ambulances; Batch Gate Lockers; Batch Hopperman; Car and Truck Washers; Forl Lifts and Hoisters; Helpers; Mechanics Helpers and Greasers; Oil Distributors, two-man operation; Pavement Breakers Pole Trailer, up to 40 feet; Power Mower Tractors; Skipman; Slurry Trucks, two-man operation; Teamsters; Truck Drivers hauling warning lights, barricades, and portable toilets on the job site

Group 2 - Dump Crets and Adgetators under 7 yards; Dumpsters, Track Trucks, Euclids, Hug Bottom Dump Turnapulls or Turnatrailers when pulling other than self-loading equipment or similar equipment under 16 cubic yards; Mixer Trucks under 7 yards; Ready-Mix Plant Hopper Operator; Winch Trucks, 2 Axles

Group 3 - Dump Crets and Adgetators, 7 yards and over; Dumpsters, Track Trucks, Euclids, Hug Bottom Dump Turnapulls or Turnatrailers when pulling other than self-loading equipment or similar equipment over 16 cubic yards; Explosives and/or Fission Material Trucks; Mixer Trucks 7 yards or over; Mobile Cranes while in transit; Oil Distributors, one-man operation Pole Trailer, over 40 feet; Pole and Expandable Trailers hauling material over 50 feet long, additional \$0.50 per hour; Slurry Trucks, one-man operation; Winch Trucks, 3 axles or more *Mechanic*Truck Welder and Truck Painter; *Winter Rate: Between Dec. 15 and Feb. 28 the mechanic and welder rate shall be \$2.00 less than the scheduled scale. Truck Painter and Truck Welder classifications shall only apply in areas where and when it has been a past area practice; Dual-purpose vehicels, such as mounted crane tucks with hoist and accessories

Group 4 - Foreman; Master Mechanic; Self-loading equipment like P.B. and trucks with scoops on the front

* TEAM0330-002 06/01/2017

DEKALB COUNTY

	Rates	Fringes
TRUCK DRIVER		
2-3 AXLES.....	\$ 36.64	0.15+a
4 AXLES.....	\$ 36.79	0.15+a
5 AXLES.....	\$ 36.99	0.15+a
6 AXLES.....	\$ 37.19	0.15+a

FOOTNOTE: a. \$780.90 per week

An additional \$.20 per axle shall be paid for all vehicles with more than six (6) axles.

OWNER COPY

Paid Holidays: New Year's Day, Memorial Day, Independence Day, Labor Day, Thanksgiving Day, and Christmas Day.

900 straight time hours or more in 1 calendar year for the same employer shall receive 1 week paid vacation; 3 years - 2 weeks paid vacation; 10 years - 3 weeks paid vacation; 20 years - 4 weeks paid vacation.

CLASSIFICATIONS:

Group 1 - Frame Truck when used for transportation purposes; Air Compressor and Welding Machines, including those pulled by cars, pick-up trucks and tractors; Ambulances; Articulated Dumps; Batch Gate Lockers; Batch Hopperman; Car and Truck Washers; Carry Alls; Forl Lifts and Hoisters; Helpers; Mechanics Helpers and Greasers; Oil Distributors, two-man operation; Pavement Breakers; Pole Trailer, up to 40 feet; Pothole Repair Trucks; Power Mower Tractors; Quick Change Barrier; Self-Propelled Chip Spreader; Shipping and Receiving Clerks and Checkers; Skipman; Slurry Trucks, two-man operation; Slurry Trucks, Conveyor Operated - 2 or 3 man operation; Teamsters; Unskilled Dumpmen; Warehousemen and Dockmen; Truck Drivers hauling warning lights, barricades, and portable toilets on the job site

Group 2 - Dispatcher; Dump Crets and Adgetators under 7 yards; Dumpsters, Track Trucks, Euclids, Hug Bottom Dump Turnapulls or Turnatrailers when pulling other than self-loading equipment or similar equipment under 16 cubic yards; Mixer Trucks under 7 yards; Ready-Mix Plant Hopper Operator; Winch Trucks, 2 Axles

Group 3 - Dump Crets and Adgetators, 7 yards and over; Dumpsters, Track Trucks, Euclids, Hug Bottom Dump Turnapulls or Turnatrailers when pulling other than self-loading equipment or similar equipment over 16 cubic yards; Explosives and/or Fission Material Trucks; Mixer Trucks 7 yards or over; Mobile Cranes while in transit; Oil Distributors, one-man operation; Pole Trailer, over 40 feet; Pole and Expandable Trailers hauling material over 50 feet long; Slurry Trucks, one-man operation; Winch Trucks, 3 axles or more; Mechanic - *Truck Welder and *Truck Painter*These classifications shall only apply in areas where and when it has been a past area practice; Asphalt Plant Operators in areas where it has been past practice

Group 4 - Dual-purpose vehicels, such as mounted crane tucks with hoist and accessories; Foreman; Master Mechanic; Self-loading equipment like P.B. and trucks with scoops on the front

* TEAM0673-003 06/01/2017

DU PAGE and KANE COUNTIES

	Rates	Fringes
TRUCK DRIVER		
2-3 AXLES.....	\$ 36.93	0.15+a
4 AXLES.....	\$ 37.08	0.15+a
5 AXLES.....	\$ 37.28	0.15+a
6 AXLES.....	\$ 37.48	0.15+a

OWNER COPY

FOOTNOTE: a. \$767.70 per week.

An additional \$.20 per axle shall be paid for all vehicles with more than six (6) axles.

Paid Holidays: New Year's Day, Memorial Day, Independence Day, Labor Day, Thanksgiving Day, and Christmas Day.

900 straight time hours or more in 1 calendar year for the same employer shall receive 1 week paid vacation; 3 years - 2 weeks paid vacation; 10 years - 3 weeks paid vacation; 20 years - 4 weeks paid vacation.

CLASSIFICATIONS:

Group 1 - Frame Truck when used for transportation purposes; Air Compressor and Welding Machines, including those pulled by cars, pick-up trucks and tractors; Ambulances; Articulated Dumps; Batch Gate Lockers; Batch Hopperman; Car and Truck Washers; Carry Alls; Forl Lifts and Hoisters; Helpers; Mechanics Helpers and Greasers; Oil Distributors, two-man operation; Pavement Breakers; Pole Trailer, up to 40 feet; Pothole Repair Trucks; Power Mower Tractors; Quick Change Barrier; Self-Propelled Chip Spreader; Shipping and Receiving Clerks and Checkers; Skipman; Slurry Trucks, two-man operation; Slurry Trucks, Conveyor Operated - 2 or 3 man operation; Teamsters; Unskilled Dumpmen; Warehousemen and Dockmen; Truck Drivers hauling warning lights, barricades, and portable toilets on the job site

Group 2 - Dispatcher; Dump Crets and Adgetators under 7 yards; Dumpsters, Track Trucks, Euclids, Hug Bottom Dump Turnapulls or Turnatrailers when pulling other than self-loading equipment or similar equipment under 16 cubic yards; Mixer Trucks under 7 yards; Ready-Mix Plant Hopper Operator; Winch Trucks, 2 Axles

Group 3 - Dump Crets and Adgetators, 7 yards and over; Dumpsters, Track Trucks, Euclids, Hug Bottom Dump Turnapulls or Turnatrailers when pulling other than self-loading equipment or similar equipment over 16 cubic yards; Explosives and/or Fission Material Trucks; Mixer Trucks 7 yards or over; Mobile Cranes while in transit; Oil Distributors, one-man operation; Pole Trailer, over 40 feet; Pole and Expandable Trailers hauling material over 50 feet long; Slurry Trucks, one-man operation; Winch Trucks, 3 axles or more; Mechanic - *Truck Welder and *Truck Painter*These classifications shall only apply in areas where and when it has been a past area practice; Asphalt Plant Operators in areas where it has been past practice

Group 4 - Dual-purpose vehicels, such as mounted crane tucks with hoist and accessories; Foreman; Master Mechanic; Self-loading equipment like P.B. and trucks with scoops on the front

WELDERS - Receive rate prescribed for craft performing operation to which welding is incidental.

=====

Note: Executive Order (EO) 13706, Establishing Paid Sick Leave

OWNER COPY

for Federal Contractors applies to all contracts subject to the Davis-Bacon Act for which the contract is awarded (and any solicitation was issued) on or after January 1, 2017. If this contract is covered by the EO, the contractor must provide employees with 1 hour of paid sick leave for every 30 hours they work, up to 56 hours of paid sick leave each year. Employees must be permitted to use paid sick leave for their own illness, injury or other health-related needs, including preventive care; to assist a family member (or person who is like family to the employee) who is ill, injured, or has other health-related needs, including preventive care; or for reasons resulting from, or to assist a family member (or person who is like family to the employee) who is a victim of, domestic violence, sexual assault, or stalking. Additional information on contractor requirements and worker protections under the EO is available at www.dol.gov/whd/govcontracts.

Unlisted classifications needed for work not included within the scope of the classifications listed may be added after award only as provided in the labor standards contract clauses (29CFR 5.5 (a) (1) (ii)).

The body of each wage determination lists the classification and wage rates that have been found to be prevailing for the cited type(s) of construction in the area covered by the wage determination. The classifications are listed in alphabetical order of "identifiers" that indicate whether the particular rate is a union rate (current union negotiated rate for local), a survey rate (weighted average rate) or a union average rate (weighted union average rate).

Union Rate Identifiers

A four letter classification abbreviation identifier enclosed in dotted lines beginning with characters other than "SU" or "UAVG" denotes that the union classification and rate were prevailing for that classification in the survey. Example: PLUM0198-005 07/01/2014. PLUM is an abbreviation identifier of the union which prevailed in the survey for this classification, which in this example would be Plumbers. 0198 indicates the local union number or district council number where applicable, i.e., Plumbers Local 0198. The next number, 005 in the example, is an internal number used in processing the wage determination. 07/01/2014 is the effective date of the most current negotiated rate, which in this example is July 1, 2014.

Union prevailing wage rates are updated to reflect all rate changes in the collective bargaining agreement (CBA) governing this classification and rate.

Survey Rate Identifiers

Classifications listed under the "SU" identifier indicate that no one rate prevailed for this classification in the survey and the published rate is derived by computing a weighted average rate based on all the rates reported in the survey for that classification. As this weighted average rate includes all rates reported in the survey, it may include both union and non-union rates. Example: SULA2012-007 5/13/2014. SU indicates the rates are survey rates based on a weighted average

OWNER COPY

calculation of rates and are not majority rates. LA indicates the State of Louisiana. 2012 is the year of survey on which these classifications and rates are based. The next number, 007 in the example, is an internal number used in producing the wage determination. 5/13/2014 indicates the survey completion date for the classifications and rates under that identifier.

Survey wage rates are not updated and remain in effect until a new survey is conducted.

Union Average Rate Identifiers

Classification(s) listed under the UAVG identifier indicate that no single majority rate prevailed for those classifications; however, 100% of the data reported for the classifications was union data. EXAMPLE: UAVG-OH-0010 08/29/2014. UAVG indicates that the rate is a weighted union average rate. OH indicates the state. The next number, 0010 in the example, is an internal number used in producing the wage determination. 08/29/2014 indicates the survey completion date for the classifications and rates under that identifier.

A UAVG rate will be updated once a year, usually in January of each year, to reflect a weighted average of the current negotiated/CBA rate of the union locals from which the rate is based.

WAGE DETERMINATION APPEALS PROCESS

1.) Has there been an initial decision in the matter? This can be:

- * an existing published wage determination
- * a survey underlying a wage determination
- * a Wage and Hour Division letter setting forth a position on a wage determination matter
- * a conformance (additional classification and rate) ruling

On survey related matters, initial contact, including requests for summaries of surveys, should be with the Wage and Hour Regional Office for the area in which the survey was conducted because those Regional Offices have responsibility for the Davis-Bacon survey program. If the response from this initial contact is not satisfactory, then the process described in 2.) and 3.) should be followed.

With regard to any other matter not yet ripe for the formal process described here, initial contact should be with the Branch of Construction Wage Determinations. Write to:

Branch of Construction Wage Determinations
Wage and Hour Division
U.S. Department of Labor
200 Constitution Avenue, N.W.
Washington, DC 20210

2.) If the answer to the question in 1.) is yes, then an interested party (those affected by the action) can request review and reconsideration from the Wage and Hour Administrator (See 29 CFR Part 1.8 and 29 CFR Part 7). Write to:

OWNER COPY

CONTRACT

Wage and Hour Administrator
U.S. Department of Labor
200 Constitution Avenue, N.W.
Washington, DC 20210

The request should be accompanied by a full statement of the interested party's position and by any information (wage payment data, project description, area practice material, etc.) that the requestor considers relevant to the issue.

3.) If the decision of the Administrator is not favorable, an interested party may appeal directly to the Administrative Review Board (formerly the Wage Appeals Board). Write to:

Administrative Review Board
U.S. Department of Labor
200 Constitution Avenue, N.W.
Washington, DC 20210

4.) All decisions by the Administrative Review Board are final.

=====

END OF GENERAL DECISION

OWNER COPY

CONTRACT

General Decision Number: IL180020 06/15/2018 IL20

Superseded General Decision Number: IL20170020

State: Illinois

Construction Types: Building Landscape, Heavy Landscape, Highway Landscape and Residential Landscape

Counties: Boone, Cook, De Kalb, Du Page, Grundy, Henry, Kane, Kankakee, Kendall, Lake, McHenry, McLean, Ogle, Peoria, Rock Island, Tazewell, Will, Winnebago and Woodford Counties in Illinois.

LANDSCAPING WORK ON BUILDING, RESIDENTIAL, HEAVY AND HIGHWAY CONSTRUCTION PROJECTS.

Note: Under Executive Order (EO) 13658, an hourly minimum wage of \$10.35 for calendar year 2018 applies to all contracts subject to the Davis-Bacon Act for which the contract is awarded (and any solicitation was issued) on or after January 1, 2015. If this contract is covered by the EO, the contractor must pay all workers in any classification listed on this wage determination at least \$10.35 per hour (or the applicable wage rate listed on this wage determination, if it is higher) for all hours spent performing on the contract in calendar year 2018. The EO minimum wage rate will be adjusted annually. Please note that this EO applies to the above-mentioned types of contracts entered into by the federal government that are subject to the Davis-Bacon Act itself, but it does not apply to contracts subject only to the Davis-Bacon Related Acts, including those set forth at 29 CFR 5.1(a)(2)-(60). Additional information on contractor requirements and worker protections under the EO is available at www.dol.gov/whd/govcontracts.

Modification Number	Publication Date
0	01/05/2018
1	04/27/2018
2	05/04/2018
3	05/11/2018
4	06/15/2018

* ENGI0150-013 06/01/2018

BUILDING AND HIGHWAY CONSTRUCTION (LANDSCAPE WORK): The landscape work for the Landscape Equipment Operator excludes the preparation of sub-grade prior to application of finish landscape materials and the utilization of any equipment over one cubic yard.

BOONE, COOK, DUPAGE, GRUNDY, KANE, KENDALL, LAKE, MCHENRY, AND WILL COUNTIES

	Rates	Fringes
Operators:.....	\$ 31.85	6.50+A+B
Includes Angle Dozer, Small; Bobcat and other similar type machines, 1 cu yd or less; Chipping Machine; Combination Backhoe and Front End Loader 1 cu yd or less; Fork Lift Truck;		

Hi-Reach and High-Ranger;Hydraulic Boom with Clam;Log Skidder; Sttraw Blower and Seeder; Stump Machine;Tractors, Crawlers, Rubber Tire Tractors, Highlift Shovels or Front End Loaders 1 cu yd or less; Tree Spades, all; Utility Tractor and attachments, and Rubber Tire Front End loader or similar machine of 1 to 1.5 cu yd solely used for placement of large decorative boulders, trees with balled soil, and other decorative landscape material too large to be accommodated in a 1 cu yd bucket. All other equipment utilized for performing landscape work, tree trimming or removal of stees, and to install plants; transport trees; excavate plant pits; place soil and other landscape materials; and apply finish landscape material on subgrade prepared by others

FOOTNOTE:

A. Health and Welfare contribution is \$1,296.00 per month.

B. Paid Holidays: New Year's Day; Memorial Day; Fourth of July; Labor Day; Thanksgiving Day; and Christmas Day provided that all such employees shall have in fact worked their regularly scheduled work day immediately preceding and the regularly scheduled work day immediately succeeding the occurrence of such holiday.

* ENGI0150-023 06/01/2018

HIGHWAY CONSTRUCTION (LANDSCAPE WORK): The landscape work for the Landscape Equipment Operator excludes the preparation of sub-grade prior to application of finish landscape materials and the utilization of any equipment over one cubic yard.

HENRY, MCLEAN, OGLE, PEORIA, ROCK ISLAND, TAZEWELL, WINNEBAGO, and WOODFORD COUNTIES

Rates Fringes

Operators:.....\$ 31.85 6.50+A+B

Includes the following: Angle Dozer, Small; Bobcat and other similar type machines, 1 cu yd or less; Chipping Machine; Combination Backhoe and Front End Loader 1 cu yd or less; Fork Lift Truck; Hi-Reach and High-Ranger;Hydraulic Boom with Clam;Log Skidder; Sttraw Blower and Seeder; Stump Machine;Tractors, Crawlers, Rubber Tire Tractors, Highlift Shovels or Front End Loaders 1 cu yd or less; Tree Spades, all; Utility Tractor and attachments, and Rubber Tire Front End loader or similar machine of 1 to 1.5 cu yd solely used for placement of large decorative boulders, trees with balled soil, and other decorative landscape material too large to be accommodated in a 1 cu yd bucket. All other equipment utilized for performing landscape work, tree trimming or removal of stees, and to install plants; transport trees; excavate plant pits; place soil and other landscape materials; and apply finish landscape material on subgrade prepared by others

FOOTNOTE:

A. Health and Welfare contribution is \$1,296.00 per month.

B. Paid Holidays: New Year's Day; Memorial Day; Fourth of

OWNER COPY

July; Labor Day; Thanksgiving Day; and Christmas Day provided that all such employees shall have in fact worked their regularly scheduled work day immediately preceding and the regularly scheduled work day immediately succeeding the occurrence of such holiday.

LAB00032-004 05/01/2018

HIGHWAY CONSTRUCTION

WINNEBAGO COUNTY

	Rates	Fringes
Landscape Laborer.....	\$ 35.40	31.73

LAB00362-003 05/01/2018

HIGHWAY CONSTRUCTION

MCLEAN COUNTY

	Rates	Fringes
Landscape Laborer.....	\$ 31.08	24.43

LAB00751-004 05/01/2012

HIGHWAY CONSTRUCTION

KANKAKEE COUNTY

	Rates	Fringes
Landscape Laborer.....	\$ 33.16	20.66

LAB00852-004 05/01/2006

HIGHWAY CONSTRUCTION

ROCK ISLAND AND HENRY COUNTIES

	Rates	Fringes
Landscape Laborer.....	\$ 21.94	12.79

LAB00996-004 05/01/2018

HIGHWAY CONSTRUCTION

PEORIA, TAZEWELL, AND WOODFORD COUNTIES

	Rates	Fringes
Landscape Laborer.....	\$ 32.73	23.74

TEAM0026-005 05/01/2017

MCLEAN (South of a straight line from where Route 24 intersects the Woodford County line in a Southeast direction to the South Southwest corner of Livingston County) COUNTY

Rates Fringes

TRUCK DRIVER

Group 1.....	\$ 36.15	18.30
Group 2.....	\$ 36.67	18.30
Group 3.....	\$ 36.91	18.30
Group 4.....	\$ 37.25	18.30
Group 5.....	\$ 38.23	18.30

CLASSIFICATIONS:

GROUP 1: Drivers on 2 axles hauling less than 9 tons; air compressor & welding machines and brooms, including those pulled by separate units; Truck Driver Helper, warehouse employees; Mechanic Helpers; greasers and tiremen; pick-up trucks when hauling material, tools, or workers to and from and on the job site; and forklifts up to 6,000 lb capacity.

GROUP 2: 2 or 3 axles hauling more than 9 tons but hauling less than 16 tons; A-frame winch trucks; hydrolift trucks; Vactor Trucks or similar equipment when used for transportation purposes; Forklift over 6,000 lb.capacity; winch trucks; and four axle combination units.

GROUP 3: 2, 3 or 4 Axles hauling 16 tons or more; 5-Axles or more combination units; drivers on water pulls; articulated dump trucks; mechanics and working forepersons.

GROUP 4: Low Boy and Oil Distributors.

GROUP 5: Drivers who require special protective clothing while employed on hazardous waste work.

* TEAM0179-004 06/01/2017

GRUNDY, KENDALL, MCLEAN (North of a straight line starting at the intersection of McLean-Woodford Counties line & Route 24 in a Southeastern direction to the South Southwest corner of Livingston County), WILL, and WOODFORD (Northeast corner east of Route 51/251 & North of Route 24) COUNTIES

Rates Fringes

TRUCK DRIVER

2-3 AXLES.....	\$ 37.68	0.15+a
4 AXLES.....	\$ 37.83	0.15+a
5 AXLES.....	\$ 38.03	0.15+a
6 AXLES.....	\$ 38.23	0.15+a

FOOTNOTES:

- a. \$733.20 per week.
- b. Lowboy rate based on number of axles

An additional \$.20 per axle shall be paid for all vehicles with more than six (6) axles.

CLASSIFICATIONS:

Group 1 - Frame Truck when used for transportation purposes; Air Compressor and Welding Machines, including those pulled by cars, pick-up trucks and tractors; Ambulances; Articulated Dumps; Batch Gate Lockers; Batch Hopperman; Car and Truck Washers; Carry Alls; Forl Lifts and Hoisters; Helpers; Mechanics Helpers and Greasers; Oil Distributors,

two-man operation; Pavement Breakers; Pole Trailer, up to 40 feet; Pothole Repair Trucks; Power Mower Tractors; Quick Change Barrier; Self-Propelled Chip Spreader; Shipping and Receiving Clerks and Checkers; Skipman; Slurry Trucks, two-man operation; Slurry Trucks, Conveyor Operated - 2 or 3 man operation; Teamsters; Unskilled Dumpmen; Warehousemen and Dockmen; Truck Drivers hauling warning lights, barricades, and portable toilets on the job site

Group 2 - Dispatcher; Dump Crets and Adgetators under 7 yards; Dumpsters, Track Trucks, Euclids, Hug Bottom Dump Turnapulls or Turnatrailers when pulling other than self-loading equipment or similar equipment under 16 cubic yards; Mixer Trucks under 7 yards; Ready-Mix Plant Hopper Operator; Winch Trucks, 2 Axles

Group 3 - Dump Crets and Adgetators, 7 yards and over; Dumpsters, Track Trucks, Euclids, Hug Bottom Dump Turnapulls or Turnatrailers when pulling other than self-loading equipment or similar equipment over 16 cubic yards; Explosives and/or Fission Material Trucks; Mixer Trucks 7 yards or over; Mobile Cranes while in transit; Oil Distributors, one-man operation; Pole Trailer, over 40 feet; Pole and Expandable Trailers hauling material over 50 feet long; Slurry Trucks, one-man operation; Winch Trucks, 3 axles or more; Mechanic - *Truck Welder and *Truck Painter*These classifications shall only apply in areas where and when it has been a past area practice; Asphalt Plant Operators in areas where it has been past practice

Group 4 - Dual-purpose vehicels, such as mounted crane tucks with hoist and accessories; Foreman; Master Mechanic; Self-loading equipment like P.B. and trucks with scoops on the front

* TEAM0179-008 06/01/2016

KANKAKEE COUNTY

	Rates	Fringes
TRUCK DRIVER		
2 or 3 axles.....	\$ 37.68	0.15+a
4 axles.....	\$ 37.83	0.15+a
5 axles.....	\$ 38.03	0.15+a
6 axles.....	\$ 38.23	0.15+a

FOOTNOTES:

- a. \$733.20 per week.
- b. Lowboy rate based on number of axles

An additional \$.20 per axle shall be paid for all vehicles with more than six (6) axles.

CLASSIFICATIONS:

Group 1 - Frame Truck when used for transportation purposes; Air Compressor and Welding Machines, including those pulled by cars, pick-up trucks and tractors; Ambulances; Articulated Dumps; Batch Gate Lockers; Batch Hopperman; Car and Truck Washers; Carry Alls; Forl Lifts and Hoisters; Helpers; Mechanics Helpers and Greasers; Oil Distributors, two-man operation; Pavement Breakers; Pole Trailer, up to

OWNER COPY

40 feet; Pothole Repair Trucks; Power Mower Tractors; Quick Change Barrier; Self-Propelled Chip Spreader; Shipping and Receiving Clerks and Checkers; Skipman; Slurry Trucks, two-man operation; Slurry Trucks, Conveyor Operated - 2 or 3 man operation; Teamsters; Unskilled Dumpmen; Warehousemen and Dockmen; Truck Drivers hauling warning lights, barricades, and portable toilets on the job site

Group 2 - Dispatcher; Dump Crets and Adgetators under 7 yards; Dumpsters, Track Trucks, Euclids, Hug Bottom Dump Turnapulls or Turnatrailers when pulling other than self-loading equipment or similar equipment under 16 cubic yards; Mixer Trucks under 7 yards; Ready-Mix Plant Hopper Operator; Winch Trucks, 2 Axles

Group 3 - Dump Crets and Adgetators, 7 yards and over; Dumpsters, Track Trucks, Euclids, Hug Bottom Dump Turnapulls or Turnatrailers when pulling other than self-loading equipment or similar equipment over 16 cubic yards; Explosives and/or Fission Material Trucks; Mixer Trucks 7 yards or over; Mobile Cranes while in transit; Oil Distributors, one-man operation; Pole Trailer, over 40 feet; Pole and Expandable Trailers hauling material over 50 feet long; Slurry Trucks, one-man operation; Winch Trucks, 3 axles or more; Mechanic - *Truck Welder and *Truck Painter*These classifications shall only apply in areas where and when it has been a past area practice; Asphalt Plant Operators in areas where it has been past practice

Group 4 - Dual-purpose vehicels, such as mounted crane tucks with hoist and accessories; Foreman; Master Mechanic; Self-loading equipment like P.B. and trucks with scoops on the front

* TEAM0301-001 06/01/2017

LAKE AND MCHENRY COUNTIES

	Rates	Fringes
TRUCK DRIVER		
2-3 AXLES.....	\$ 37.69	10.15+a
4 AXLES.....	\$ 37.84	10.15+a
5 AXLES.....	\$ 38.04	10.15+a
6 AXLES.....	\$ 38.24	10.15+a

FOOTNOTES:

- a. 325.20 per week.
- b. Lowboy rate based on number of axles

An additional \$.20 per axle shall be paid for all vehicles with more than six (6) axles.

Paid Holidays: New Year's Day, Memorial Day, Independence Day, Labor Day, Thanksgiving Day, and Christmas Day.

900 straight time hours or more in 1 calendar year for the same employer shall receive 1 week paid vacation; 3 years - 2 weeks paid vacation; 10 years - 3 weeks paid vacation; 20 years - 4 weeks paid vacation.

CLASSIFICATIONS:

OWNER COPY

Group 1 - Frame Truck when used for transportation purposes; Air Compressor and Welding Machines, including those pulled by cars, pick-up trucks and tractors; Ambulances; Articulated Dumps; Batch Gate Lockers; Batch Hopperman; Car and Truck Washers; Carry Alls; Forl Lifts and Hoisters; Helpers; Mechanics Helpers and Greasers; Oil Distributors, two-man operation; Pavement Breakers; Pole Trailer, up to 40 feet; Pothole Repair Trucks; Power Mower Tractors; Quick Change Barrier; Self-Propelled Chip Spreader; Shipping and Receiving Clerks and Checkers; Skipman; Slurry Trucks, two-man operation; Slurry Trucks, Conveyor Operated - 2 or 3 man operation; Teamsters; Unskilled Dumpmen; Warehousemen and Dockmen; Truck Drivers hauling warning lights, barricades, and portable toilets on the job site

Group 2 - Dispatcher; Dump Crets and Adgetators under 7 yards; Dumpsters, Track Trucks, Euclids, Hug Bottom Dump Turnapulls or Turnatrailers when pulling other than self-loading equipment or similar equipment under 16 cubic yards; Mixer Trucks under 7 yards; Ready-Mix Plant Hopper Operator; Winch Trucks, 2 Axles

Group 3 - Dump Crets and Adgetators, 7 yards and over; Dumpsters, Track Trucks, Euclids, Hug Bottom Dump Turnapulls or Turnatrailers when pulling other than self-loading equipment or similar equipment over 16 cubic yards; Explosives and/or Fission Material Trucks; Mixer Trucks 7 yards or over; Mobile Cranes while in transit; Oil Distributors, one-man operation; Pole Trailer, over 40 feet; Pole and Expandable Trailers hauling material over 50 feet long; Slurry Trucks, one-man operation; Winch Trucks, 3 axles or more; Mechanic - *Truck Welder and *Truck Painter*These classifications shall only apply in areas where and when it has been a past area practice; Asphalt Plant Operators in areas where it has been past practice

Group 4 - Dual-purpose vehicels, such as mounted crane tucks with hoist and accessories; Foreman; Master Mechanic; Self-loading equipment like P.B. and trucks with scoops on the front

* TEAM0325-004 06/01/2017

BOONE and WINNEBAGO COUNTIES

	Rates	Fringes
TRUCK DRIVER		
2 - 3 Axles.....	\$ 36.62	20.40
4 Axles.....	\$ 36.77	20.40
5 Axles.....	\$ 36.97	20.40
6 Axles.....	\$ 37.08	20.40

FOOTNOTE: An additional \$.20 per axle shall be paid for all vehicles with more than six (6) axles.

CLASSIFICATIONS:

Group 1 - Frame Truck when used for transportation purposes; Air Compressor and Welding Machines, including those pulled by cars, pick-up trucks and tractors; Ambulances; Batch Gate Lockers; Batch Hopperman; Car and Truck Washers; Forl Lifts and Hoisters; Helpers;

OWNER COPY

Mechanics Helpers and Greasers; Oil Distributors, two-man operation; Pavement Breakers
Pole Trailer, up to 40 feet; Power Mower Tractors; Skipman; Slurry Trucks, two-man operation; Teamsters; Truck Drivers hauling warning lights, barricades, and portable toilets on the job site

Group 2 - Dump Crets and Adgetators under 7 yards; Dumpsters, Track Trucks, Euclids, Hug Bottom Dump Turnapulls or Turnatrailers when pulling other than self-loading equipment or similar equipment under 16 cubic yards; Mixer Trucks under 7 yards; Ready-Mix Plant Hopper Operator; Winch Trucks, 2 Axles

Group 3 - Dump Crets and Adgetators, 7 yards and over; Dumpsters, Track Trucks, Euclids, Hug Bottom Dump Turnapulls or Turnatrailers when pulling other than self-loading equipment or similar equipment over 16 cubic yards; Explosives and/or Fission Material Trucks; Mixer Trucks 7 yards or over; Mobile Cranes while in transit; Oil Distributors, one-man operation
Pole Trailer, over 40 feet; Pole and Expandable Trailers hauling material over 50 feet long, additional \$0.50 per hour; Slurry Trucks, one-man operation; Winch Trucks, 3 axles or more
*Mechanic*Truck Welder and Truck Painter; *Winter Rate: Between Dec. 15 and Feb. 28 the mechanic and welder rate shall be \$2.00 less than the scheduled scale. Truck Painter and Truck Welder classifications shall only apply in areas where and when it has been a past area practice; Dual-purpose vehicels, such as mounted crane tucks with hoist and accessories

Group 4 - Foreman; Master Mechanic; Self-loading equipment like P.B. and trucks with scoops on the front

* TEAM0330-004 06/01/2017

DEKALB and OGLE (North of Route 72/East of Route 251, Adeline, Byron, Creston, Dement, Forreston North of Route 72, Leaf River North of Route 72, Lynnville, Monroe, Rochelle, & Scott) COUNTIES

	Rates	Fringes
TRUCK DRIVER		
2-3 AXLES.....	\$ 36.64	0.15+a
4 AXLES.....	\$ 36.79	0.15+a
5 AXLES.....	\$ 36.99	0.15+a
6 AXLES.....	\$ 37.19	0.15+a

FOOTNOTE: a. \$780.90 per week

An additional \$.20 per axle shall be paid for all vehicles with more than six (6) axles.

Paid Holidays: New Year's Day, Memorial Day, Independence Day, Labor Day, Thanksgiving Day, and Christmas Day.

900 straight time hours or more in 1 calendar year for the same employer shall receive 1 week paid vacation; 3 years - 2 weeks paid vacation; 10 years - 3 weeks paid vacation; 20 years - 4 weeks paid vacation.

CLASSIFICATIONS:

Group 1 - Frame Truck when used for transportation purposes; Air Compressor and Welding Machines, including those pulled by cars, pick-up trucks and tractors; Ambulances; Articulated Dumps; Batch Gate Lockers; Batch Hopperman; Car and Truck Washers; Carry Alls; Forl Lifts and Hoisters; Helpers; Mechanics Helpers and Greasers; Oil Distributors, two-man operation; Pavement Breakers; Pole Trailer, up to 40 feet; Pothole Repair Trucks; Power Mower Tractors; Quick Change Barrier; Self-Propelled Chip Spreader; Shipping and Receiving Clerks and Checkers; Skipman; Slurry Trucks, two-man operation; Slurry Trucks, Conveyor Operated - 2 or 3 man operation; Teamsters; Unskilled Dumpmen; Warehousemen and Dockmen; Truck Drivers hauling warning lights, barricades, and portable toilets on the job site

Group 2 - Dispatcher; Dump Crets and Adgetators under 7 yards; Dumpsters, Track Trucks, Euclids, Hug Bottom Dump Turnapulls or Turnatrailers when pulling other than self-loading equipment or similar equipment under 16 cubic yards; Mixer Trucks under 7 yards; Ready-Mix Plant Hopper Operator; Winch Trucks, 2 Axles

Group 3 - Dump Crets and Adgetators, 7 yards and over; Dumpsters, Track Trucks, Euclids, Hug Bottom Dump Turnapulls or Turnatrailers when pulling other than self-loading equipment or similar equipment over 16 cubic yards; Explosives and/or Fission Material Trucks; Mixer Trucks 7 yards or over; Mobile Cranes while in transit; Oil Distributors, one-man operation; Pole Trailer, over 40 feet; Pole and Expandable Trailers hauling material over 50 feet long; Slurry Trucks, one-man operation; Winch Trucks, 3 axles or more; Mechanic - *Truck Welder and *Truck Painter*These classifications shall only apply in areas where and when it has been a past area practice; Asphalt Plant Operators in areas where it has been past practice

Group 4 - Dual-purpose vehicels, such as mounted crane tucks with hoist and accessories; Foreman; Master Mechanic; Self-loading equipment like P.B. and trucks with scoops on the front

TEAM0371-004 05/01/2017

HENRY and ROCK ISLAND COUNTIES

	Rates	Fringes
TRUCK DRIVER		
Group 1.....	\$ 36.26	18.51
Group 2.....	\$ 36.77	18.51
Group 3.....	\$ 37.05	18.51
Group 4.....	\$ 37.36	18.51
Group 5.....	\$ 38.35	18.51

CLASSIFICATIONS:

GROUP 1: Drivers on 2 axles hauling less than 9 tons; air compressor & welding machines and brooms, including those pulled by separate units; Truck Driver Helper, warehouse employees; Mechanic Helpers; greasers and tiremen; pick-up

trucks when hauling material, tools, or workers to and from and on the job site; and forklifts up to 6,000 lb capacity.

GROUP 2: 2 or 3 axles hauling more than 9 tons but hauling less than 16 tons; A-frame winch trucks; hydrolift trucks; Vactor Trucks or similar equipment when used for transportation purposes; Forklift over 6,000 lb.capacity; winch trucks; and four axle combination units.

GROUP 3: 2, 3 or 4 Axles hauling 16 tons or more; 5-Axles or more combination units; drivers on water pulls; articulated dump trucks; mechanics and working forepersons.

GROUP 4: Low Boy and Oil Distributors.

GROUP 5: Drivers who require special protective clothing while employed on hazardous waste work.

TEAM0627-004 05/01/2017

PEORIA, TAZEWELL, and WOODFORD COUNTIES

	Rates	Fringes
TRUCK DRIVER		
Group 1.....	\$ 36.15	18.30
Group 2.....	\$ 36.67	18.30
Group 3.....	\$ 36.91	18.30
Group 4.....	\$ 37.25	18.30
Group 5.....	\$ 38.23	18.30

CLASSIFICATIONS:

GROUP 1: Drivers on 2 axles hauling less than 9 tons; air compressor & welding machines and brooms, including those pulled by separate units; Truck Driver Helper, warehouse employees; Mechanic Helpers; greasers and tiremen; pick-up trucks when hauling material, tools, or workers to and from and on the job site; and forklifts up to 6,000 lb capacity.

GROUP 2: 2 or 3 axles hauling more than 9 tons but hauling less than 16 tons; A-frame winch trucks; hydrolift trucks; Vactor Trucks or similar equipment when used for transportation purposes; Forklift over 6,000 lb.capacity; winch trucks; and four axle combination units.

GROUP 3: 2, 3 or 4 Axles hauling 16 tons or more; 5-Axles or more combination units; drivers on water pulls; articulated dump trucks; mechanics and working forepersons.

GROUP 4: Low Boy and Oil Distributors.

GROUP 5: Drivers who require special protective clothing while employed on hazardous waste work.

* TEAM0673-003 06/01/2017

DU PAGE and KANE COUNTIES

	Rates	Fringes
TRUCK DRIVER		
2-3 AXLES.....	\$ 36.93	0.15+a

OWNER COPY

4 AXLES.....	\$ 37.08	0.15+a
5 AXLES.....	\$ 37.28	0.15+a
6 AXLES.....	\$ 37.48	0.15+a

FOOTNOTE: a. \$767.70 per week.

An additional \$.20 per axle shall be paid for all vehicles with more than six (6) axles.

Paid Holidays: New Year's Day, Memorial Day, Independence Day, Labor Day, Thanksgiving Day, and Christmas Day.

900 straight time hours or more in 1 calendar year for the same employer shall receive 1 week paid vacation; 3 years - 2 weeks paid vacation; 10 years - 3 weeks paid vacation; 20 years - 4 weeks paid vacation.

CLASSIFICATIONS:

Group 1 - Frame Truck when used for transportation purposes; Air Compressor and Welding Machines, including those pulled by cars, pick-up trucks and tractors; Ambulances; Articulated Dumps; Batch Gate Lockers; Batch Hopperman; Car and Truck Washers; Carry Alls; Forl Lifts and Hoisters; Helpers; Mechanics Helpers and Greasers; Oil Distributors, two-man operation; Pavement Breakers; Pole Trailer, up to 40 feet; Pothole Repair Trucks; Power Mower Tractors; Quick Change Barrier; Self-Propelled Chip Spreader; Shipping and Receiving Clerks and Checkers; Skipman; Slurry Trucks, two-man operation; Slurry Trucks, Conveyor Operated - 2 or 3 man operation; Teamsters; Unskilled Dumpmen; Warehousemen and Dockmen; Truck Drivers hauling warning lights, barricades, and portable toilets on the job site

Group 2 - Dispatcher; Dump Crets and Adgetators under 7 yards; Dumpsters, Track Trucks, Euclids, Hug Bottom Dump Turnapulls or Turnatrailers when pulling other than self-loading equipment or similar equipment under 16 cubic yards; Mixer Trucks under 7 yards; Ready-Mix Plant Hopper Operator; Winch Trucks, 2 Axles

Group 3 - Dump Crets and Adgetators, 7 yards and over; Dumpsters, Track Trucks, Euclids, Hug Bottom Dump Turnapulls or Turnatrailers when pulling other than self-loading equipment or similar equipment over 16 cubic yards; Explosives and/or Fission Material Trucks; Mixer Trucks 7 yards or over; Mobile Cranes while in transit; Oil Distributors, one-man operation; Pole Trailer, over 40 feet; Pole and Expandable Trailers hauling material over 50 feet long; Slurry Trucks, one-man operation; Winch Trucks, 3 axles or more; Mechanic - *Truck Welder and *Truck Painter*These classifications shall only apply in areas where and when it has been a past area practice; Asphalt Plant Operators in areas where it has been past practice

Group 4 - Dual-purpose vehicels, such as mounted crane tucks with hoist and accessories; Foreman; Master Mechanic; Self-loading equipment like P.B. and trucks with scoops on the front

TEAM0722-005 05/01/2015

OGLE (North of Route 72/East of Route 251) COUNTY

	Rates	Fringes
TRUCK DRIVER		
Group 1.....	\$ 34.10	17.09
Group 2.....	\$ 34.60	17.09
Group 3.....	\$ 34.82	17.09
Group 4.....	\$ 35.14	17.09
Group 5.....	\$ 36.06	17.09

CLASSIFICATIONS:

GROUP 1: Drivers on 2 axles hauling less than 9 tons; air compressor & welding machines and brooms, including those pulled by separate units; Truck Driver Helper, warehouse employees; Mechanic Helpers; greasers and tiremen; pick-up trucks when hauling material, tools, or workers to and from and on the job site; and forklifts up to 6,000 lb capacity.

GROUP 2: 2 or 3 axles hauling more than 9 tons but hauling less than 16 tons; A-frame winch trucks; hydrolift trucks; Vactor Trucks or similar equipment when used for transportation purposes; Forklift over 6,000 lb.capacity; winch trucks; and four axle combination units.

GROUP 3: 2, 3 or 4 Axles hauling 16 tons or more; 5-Axles or more combination units; drivers on water pulls; articulated dump trucks; mechanics and working forepersons.

GROUP 4: Low Boy and Oil Distributors.

GROUP 5: Drivers who require special protective clothing while employed on hazardous waste work.

TEAM0731-001 06/01/2017

COOK COUNTY - HEAVY AND HIGHWAY

	Rates	Fringes
TRUCK DRIVER		
2 or 3 Axles.....	\$ 35.60	22.10
4 Axles.....	\$ 35.85	22.10
5 Axles.....	\$ 36.05	22.10
6 Axles.....	\$ 36.25	22.10

FOOTNOTES:

A. Paid Holidays: New Year's Day, Memorial Day, Independence Day, Labor Day, Thanksgiving Day, and Christmas Day.

B. 900 straight time hours or more in 1 calendar year for the same employer shall receive 1 week paid vacation; 3 years - 2 weeks paid vacation; 10 years - 3 weeks paid vacation; 20 years - 4 weeks paid vacation.

C. An additional \$.20 per axle shall be paid for all vehicles with more than six (6) axles.

TEAM0786-001 06/01/2017

COOK COUNTY - BUILDING AND RESIDENTIAL

	Rates	Fringes
TRUCK DRIVER		
2 & 3 Axles.....	\$ 39.942	0.25+a
4 Axles.....	\$ 39.75	0.25+a
5 Axles.....	\$ 39.967	0.25+a
6 Axles.....	\$ 40.184	0.25+a

FOOTNOTES:

a. \$719.00 per week.

An additional \$.20 per axle shall be paid for all vehicles with more than six (6) axles.

Paid Holidays: New Year's Day, Memorial Day, Independence Day, Labor Day, Thanksgiving Day, and Christmas Day.

900 straight time hours or more in 1 calendar year for the same employer shall receive 1 week paid vacation; 3 years - 2 weeks paid vacation; 10 years - 3 weeks paid vacation; 20 years - 4 weeks paid vacation.

SUIL1993-001 01/19/1993

BUILDING CONSTRUCTION (LANDSCAPE WORK):

	Rates	Fringes
LABORER		
BOONE, GRUNDY, KANE, KENDALL, LAKE, MCHENRY, & WILL COUNTIES		
LANDSCAPE LABORERS.....	\$ 7.25	
COOK COUNTY		
LANDSCAPE LABORERS.....	\$ 7.25	
LANDSCAPE PLANTSMAN.....	\$ 9.80	1.82
DE KALB COUNTY		
LANDSCAPE LABORERS.....	\$ 7.25	
LANDSCAPE OPERATORS.....	\$ 7.25	
LANDSCAPE PLANTSMAN.....	\$ 9.66	.26
DU PAGE COUNTY		
LANDSCAPE LABORERS.....	\$ 7.25	
LANDSCAPE PLANTSMAN.....	\$ 9.04	1.16
GRUNDY, LAKE & WILL COUNTIES		
LANDSCAPE DRIVER 2 & 3 Axles.....		
	\$ 11.86	2.81
LANDSCAPE PLANTSMAN.....	\$ 12.00	3.32

SUIL1993-002 01/19/1993

HEAVY CONSTRUCTION (LANDSCAPE WORK)

	Rates	Fringes
LABORER		
BOONE, GRUNDY, KANE, KENDALL, LAKE, MCHENRY & WILL COUNTIES:		
LANDSCAPE DRIVER, 2 & 3 AXLES.....		
	\$ 11.94	2.42
LANDSCAPE LABORERS.....	\$ 7.25	

OWNER COPY

LANDSCAPE OPERATORS.....	\$ 13.11	3.01
LANDSCAPE PLANTSMAN.....	\$ 9.73	2.05
COOK COUNTY:		
LANDSCAPE DRIVER, 2 & 3		
AXLES.....	\$ 9.93	1.89
LANDSCAPE LABORERS.....	\$ 7.25	
LANDSCAPE OPERATORS.....	\$ 10.98	2.12
LANDSCAPE PLANTSMAN.....	\$ 10.08	2.06
DE KALB COUNTY:		
LANDSCAPE LABORERS.....	\$ 7.25	
LANDSCAPE OPERATORS.....	\$ 7.25	
LANDSCAPE PLANTSMAN.....	\$ 9.66	.26
DU PAGE COUNTY:		
LANDSCAPE DRIVER, 2 & 3		
AXLES.....	\$ 8.32	1.02
LANDSCAPE LABORERS.....	\$ 7.25	
LANDSCAPE OPERATORS.....	\$ 10.75	
LANDSCAPE PLANTSMAN.....	\$ 10.65	

SUIL1993-003 01/19/1993

HIGHWAY CONSTRUCTION (LANDSCAPE WORK):

	Rates	Fringes
LABORER		
DE KALB COUNTY		
LANDSCAPE LABORERS.....	\$ 7.25	
LANDSCAPE OPERATORS.....	\$ 7.25	
LANDSCAPE PLANTSMAN.....	\$ 9.66	.26
KANKAKEE COUNTY:		
LANDSCAPE DRIVER.....	\$ 8.75	.17
LANDSCAPE OPERATOR.....	\$ 16.57	3.56
PEORIA, TAZEWELL, & WOODFORD COUNTIES:		
TRUCK DRIVERS 2 & 3 AXLES..	\$ 17.58	5.88

WELDERS - Receive rate prescribed for craft performing operation to which welding is incidental.

=====
Note: Executive Order (EO) 13706, Establishing Paid Sick Leave for Federal Contractors applies to all contracts subject to the Davis-Bacon Act for which the contract is awarded (and any solicitation was issued) on or after January 1, 2017. If this contract is covered by the EO, the contractor must provide employees with 1 hour of paid sick leave for every 30 hours they work, up to 56 hours of paid sick leave each year. Employees must be permitted to use paid sick leave for their own illness, injury or other health-related needs, including preventive care; to assist a family member (or person who is like family to the employee) who is ill, injured, or has other health-related needs, including preventive care; or for reasons resulting from, or to assist a family member (or person who is like family to the employee) who is a victim of, domestic violence, sexual assault, or stalking. Additional information on contractor requirements and worker protections under the EO is available at www.dol.gov/whd/govcontracts.

Unlisted classifications needed for work not included within the scope of the classifications listed may be added after award only as provided in the labor standards contract clauses (29CFR 5.5 (a) (1) (ii)).

The body of each wage determination lists the classification and wage rates that have been found to be prevailing for the cited type(s) of construction in the area covered by the wage determination. The classifications are listed in alphabetical order of "identifiers" that indicate whether the particular rate is a union rate (current union negotiated rate for local), a survey rate (weighted average rate) or a union average rate (weighted union average rate).

Union Rate Identifiers

A four letter classification abbreviation identifier enclosed in dotted lines beginning with characters other than "SU" or "UAVG" denotes that the union classification and rate were prevailing for that classification in the survey. Example: PLUM0198-005 07/01/2014. PLUM is an abbreviation identifier of the union which prevailed in the survey for this classification, which in this example would be Plumbers. 0198 indicates the local union number or district council number where applicable, i.e., Plumbers Local 0198. The next number, 005 in the example, is an internal number used in processing the wage determination. 07/01/2014 is the effective date of the most current negotiated rate, which in this example is July 1, 2014.

Union prevailing wage rates are updated to reflect all rate changes in the collective bargaining agreement (CBA) governing this classification and rate.

Survey Rate Identifiers

Classifications listed under the "SU" identifier indicate that no one rate prevailed for this classification in the survey and the published rate is derived by computing a weighted average rate based on all the rates reported in the survey for that classification. As this weighted average rate includes all rates reported in the survey, it may include both union and non-union rates. Example: SULA2012-007 5/13/2014. SU indicates the rates are survey rates based on a weighted average calculation of rates and are not majority rates. LA indicates the State of Louisiana. 2012 is the year of survey on which these classifications and rates are based. The next number, 007 in the example, is an internal number used in producing the wage determination. 5/13/2014 indicates the survey completion date for the classifications and rates under that identifier.

Survey wage rates are not updated and remain in effect until a new survey is conducted.

Union Average Rate Identifiers

Classification(s) listed under the UAVG identifier indicate that no single majority rate prevailed for those classifications; however, 100% of the data reported for the classifications was union data. EXAMPLE: UAVG-OH-0010 08/29/2014. UAVG indicates that the rate is a weighted union average rate. OH indicates the state. The next number, 0010 in the example, is an internal number used in producing the wage determination. 08/29/2014 indicates the survey completion date for the classifications and rates under that identifier.

A UAVG rate will be updated once a year, usually in January of each year, to reflect a weighted average of the current negotiated/CBA rate of the union locals from which the rate is based.

WAGE DETERMINATION APPEALS PROCESS

1.) Has there been an initial decision in the matter? This can be:

- * an existing published wage determination
- * a survey underlying a wage determination
- * a Wage and Hour Division letter setting forth a position on a wage determination matter
- * a conformance (additional classification and rate) ruling

On survey related matters, initial contact, including requests for summaries of surveys, should be with the Wage and Hour Regional Office for the area in which the survey was conducted because those Regional Offices have responsibility for the Davis-Bacon survey program. If the response from this initial contact is not satisfactory, then the process described in 2.) and 3.) should be followed.

With regard to any other matter not yet ripe for the formal process described here, initial contact should be with the Branch of Construction Wage Determinations. Write to:

Branch of Construction Wage Determinations
Wage and Hour Division
U.S. Department of Labor
200 Constitution Avenue, N.W.
Washington, DC 20210

2.) If the answer to the question in 1.) is yes, then an interested party (those affected by the action) can request review and reconsideration from the Wage and Hour Administrator (See 29 CFR Part 1.8 and 29 CFR Part 7). Write to:

Wage and Hour Administrator
U.S. Department of Labor
200 Constitution Avenue, N.W.
Washington, DC 20210

The request should be accompanied by a full statement of the interested party's position and by any information (wage payment data, project description, area practice material, etc.) that the requestor considers relevant to the issue.

3.) If the decision of the Administrator is not favorable, an interested party may appeal directly to the Administrative Review Board (formerly the Wage Appeals Board). Write to:

Administrative Review Board
U.S. Department of Labor
200 Constitution Avenue, N.W.
Washington, DC 20210

4.) All decisions by the Administrative Review Board are final.

OWNER COPY

CONTRACT

=====

END OF GENERAL DECISION